



COUNTY OF SONOMA

ONSITE WASTEWATER TREATMENT SYSTEM REGULATIONS AND TECHNICAL STANDARDS

(OWTS MANUAL)

COUNTY OF SONOMA
June 4, 2024

Version 8.0

Table of Contents

Section 1 General

| | | |
|-----|---------------------|---|
| 1.1 | Purpose..... | 1 |
| 1.2 | Authority..... | 1 |
| 1.3 | Applicability | 1 |

Section 2 Sewer Connection Required

Section 3 Acronyms and Definitions

| | | |
|-----|------------------|---|
| 3.1 | Acronyms | 3 |
| 3.2 | Definitions..... | 4 |

Section 4 Criteria for All OWTS

| | | |
|------|---|----|
| 4.1 | Purpose of OWTS..... | 15 |
| 4.2 | OWTS Sizing Criteria Wastewater Flows..... | 15 |
| 4.3 | Requirement for OWTS Reserve Replacement Area..... | 16 |
| 4.4 | OWTS Designer by System Type..... | 16 |
| 4.5 | OWTS Locations and Off-Site Easements..... | 17 |
| 4.6 | Prohibitions..... | 20 |
| 4.7 | Mitigations to Prohibitions..... | 22 |
| 4.8 | Applications for Site Evaluations and Findings Reports..... | 23 |
| 4.9 | OWTS Applications..... | 24 |
| 4.10 | OWTS Construction Permits Required..... | 25 |
| 4.11 | OWTS Permit Implementation | 28 |
| 4.12 | OWTS Construction Inspections | 29 |
| 4.13 | Change of Qualified Consultant..... | 30 |
| 4.14 | General Provisions | 31 |
| 4.15 | Community Systems | 33 |
| 4.16 | Special Conditions and Exceptions | 33 |

| | | |
|------------|---|----|
| Table 4.2 | Wastewater Design Flows for Single Family Residences and Second Units..... | 15 |
| Table 4.4 | OWTS Designer by System Type..... | 17 |
| Table 4.6A | Minimum Horizontal Setbacks from Public Water Wells | 22 |
| Table 4.6B | Minimum Horizontal Setbacks from Public Water Systems..... | 22 |
| Table 4.7 | Treatment Standards for New OWTS Not in Conformance with Horizontal Separation Requirements..... | 23 |

Section 5 OWTS Abatements, Abandonments and Repairs of Failing Systems

| | | |
|-----|---|----|
| 5.1 | Abatements | 35 |
| 5.2 | Abandonments..... | 36 |
| 5.3 | Failing System Numerical Standards..... | 37 |
| 5.4 | Repair of Failing Systems | 37 |

Section 6 Requirements for Approval of Building Permits

| | | |
|-----|---|----|
| 6.1 | Building Permits Not Reviewed by Well and Septic..... | 39 |
| 6.2 | Building Permit With Plan Check..... | 39 |
| 6.3 | New Structure on Undeveloped Land | 40 |
| 6.4 | New Structure on Developed Land | 40 |
| 6.5 | Building Improvements to an Existing Structure..... | 42 |

| | | |
|------|---|----|
| 6.6 | Reserve Replacement Area and Building Improvements..... | 42 |
| 6.7 | Existing Code Compliant Septic System Documentation..... | 43 |
| 6.8 | Existing Non-Conforming Septic System Documentation | 44 |
| 6.9 | Findings Report..... | 44 |
| 6.10 | Hydraulic Load Test Guidelines..... | 46 |

Section 7 Site Evaluation Methods and Investigation Requirements

| | | |
|------|--|----|
| 7.1 | Site Evaluations | 49 |
| 7.2 | General Site Criteria..... | 49 |
| 7.3 | Soil Profile/Groundwater/Percolation Test Notification | 58 |
| 7.4 | Soil Profile Evaluations | 59 |
| 7.5 | Groundwater Table Determination..... | 62 |
| 7.6 | Soil Percolation Evaluations..... | 65 |
| 7.7 | Percolation Test Hole Construction | 67 |
| 7.8 | Percolation Test Procedures | 73 |
| 7.9 | Percolation Rate Interpretation | 73 |
| 7.10 | Wet Weather Percolation Tests | 76 |
| 7.11 | Percolation Test Submittal of Results | 76 |
| 7.12 | Cumulative Impact Studies..... | 77 |
| 7.13 | Location of Septic System Dispersal | 81 |
| 7.14 | Prior Site Evaluation Work | 84 |

| | | |
|------------|--|----|
| Table 7.2a | Sewage Application /Soil Loading Rates..... | 52 |
| Table 7.2b | Illustrative Table for Sizing Absorption Area..... | 53 |
| Table 7.2c | Setback Requirements..... | 54 |
| Table 7.2d | Setback Distance Point of Measurement by System Type | 57 |
| Table 7.5 | 50 Percent of Average Annual Rainfall by Zone | 64 |
| Table 7.6A | Un-Developed Property Percolation Test Method..... | 66 |
| Table 7.6B | Developed Property Percolation Test Method | 66 |
| Table 7.7 | Site Parameters by System Type | 68 |
| Table 7.9A | Individual Percolation Rates by System Type..... | 75 |
| Table 7.9B | Percolation Rate Conversion Chart | 75 |
| Table 7.13 | Site Evaluation Radius | 81 |

| | | |
|--------------|--|----|
| Figure 7.4 | Soil Percolation Suitability Chart for OWTS..... | 61 |
| Figure 7.7a | Percolation Test Hole Requirements..... | 71 |
| Figure 7.7b | Percolation Test Hole Requirements..... | 72 |
| Figure 7.12A | Cumulative Impact Scenarios | 78 |
| Figure 7.13 | Site Evaluation Areas | 82 |

| | | |
|---------|--|----|
| Map 7.5 | Wet Weather Groundwater Determination Zones..... | 65 |
|---------|--|----|

Section 8 Criteria for OWTS Components

| | | |
|-----|--|----|
| 8.1 | Septic Tank Requirements | 85 |
| 8.2 | Septic Tank Sizing..... | 85 |
| 8.3 | Septic Tank Watertight Test Requirements | 86 |
| 8.4 | Sump & Pump System..... | 86 |
| 8.5 | Sump & Pump Requirements | 86 |
| 8.6 | Alternating Leachfields..... | 93 |
| 8.7 | Intercept Drains..... | 93 |

| | | |
|-------------|------------------------------------|----|
| 8.8 | Stream and Driveway Crossings..... | 98 |
| Table 8.2 | Septic Tank Capacity..... | 85 |
| Figure 8.4a | Sump Detail..... | 89 |
| Figure 8.4b | Sump and Pump Requirements..... | 92 |
| Figure 8.7 | Interceptor Drain..... | 97 |

Section 9 Criteria for Standard OWTS

| | | |
|------------|---|-----|
| 9.1 | Standard OWTS..... | 99 |
| 9.2 | Standard Dispersal Trench..... | 101 |
| 9.3 | Seepage Pits..... | 103 |
| 9.4 | Gravel-less Drain Field Systems..... | 103 |
| 9.5 | Filled Land Systems..... | 104 |
| 9.6 | Shallow Sloping OWTS..... | 106 |
| 9.7 | Pressure Distribution (PD) OWTS..... | 108 |
| Table 9.1 | Illustrative Table for Linear Footage of Leach Line per Number of Bedrooms for a Standard Septic System..... | 100 |
| Table 9.5 | Filled Land OWTS Trench and Fill Requirements..... | 104 |
| Figure 9.2 | Standard Leach Line Trench..... | 102 |

Section 10 Criteria for Water Reuse

| | | |
|------|----------------|-----|
| 10.1 | Graywater..... | 112 |
|------|----------------|-----|

Section 11 Criteria for Commercial, Industrial, and Institutional OWTS

| | | |
|-------------|--|-----|
| 11.1 | Commercial, Industrial, and Institutional OWTS..... | 113 |
| 11.2 | Special/Cultural Events..... | 118 |
| 11.3 | Flow Equalization..... | 119 |
| 11.4 | Package Treatment Plants..... | 119 |
| 11.5 | Performance Wells..... | 120 |
| 11.6 | Grease Interceptors..... | 122 |
| Table 11.1A | Multiunit and Non-Residential Design Flow Rates..... | 114 |
| Table 11.1B | California Plumbing Code Estimated Wastewater Flow Rates..... | 115 |
| Table 11.1C | USEPA Typical wastewater flow rates from commercial sources..... | 117 |
| Table 11.1D | USEPA Typical wastewater flow rates from industrial sources..... | 118 |
| Table 11.2 | Special Events and OWTS Sizing Criteria..... | 119 |
| Figure 11.5 | Performance Well Detail..... | 122 |

Section 12 Non-Standard Experimental and Alternative OWTS Approval Process

| | | |
|------|---|-----|
| 12.1 | General..... | 123 |
| 12.2 | Experimental OWTS Criteria..... | 123 |
| 12.3 | Experimental OWTS Approval Process..... | 123 |
| 12.4 | Alternative OWTS Criteria..... | 125 |
| 12.5 | Alternative OWTS Approval Process..... | 125 |
| 12.6 | Approved Experimental and Alternative OWTS..... | 125 |

Section 13 Non-Standard Experimental and Alternative OWTS Standards

EXPERIMENTAL OWTS STANDARDS

| | | |
|------|--|-----|
| 13.1 | Bottomless Sand Filter OWTS (Geographical Waiver)..... | 126 |
| 13.2 | Gravel-less Pressurized Dispersal channel (GPDC)..... | 128 |

ALTERNATIVE OWTS STANDARDS

| | | |
|--------------|---|-----|
| 13.3 | Mound OWTS | 132 |
| 13.4 | At-Grade OWTS | 148 |
| 13.5 | Shallow In-Ground (SIG) OWTS | 155 |
| 13.6 | Drip Dispersal OWTS | 156 |
| 13.7 | Supplemental Treatment Units | 164 |
| Table 13.3a | Mound Separation Distances | 135 |
| Table 13.3b | Linear Loading Rates (LLR) Based on Limiting Conditions | 136 |
| Table 13.3c | Mound Slope Correction Factors | 139 |
| Table 13.3d | Mound Sand Specification | 140 |
| Table 13.3e | Mound/At-Grade Downslope Soil Cover Requirements | 143 |
| Table 13.4 | At-Grade Separation Distances | 149 |
| Figure 13.3a | Linear Loading Rate | 133 |
| Figure 13.3b | Mound Cross Section | 134 |
| Figure 13.3c | Mound Plan View | 137 |
| Figure 13.3d | Mound Sand Criteria | 141 |
| Figure 13.3e | Contour Conformance | 142 |
| Figure 13.3f | Balancing Valve | 144 |
| Figure 13.3g | Purge Valve | 144 |
| Figure 13.4a | SIG (requires pretreatment), At-Grade, Mound Soil Below Trench Bottom Requirements | 148 |
| Figure 13.4b | At-Grade | 150 |
| Figure 13.6a | Drip Trench Cross-Section | 158 |
| Figure 13.6b | Single Zone Schematic | 159 |
| Figure 13.6c | Top Feed Manifold | 160 |
| Figure 13.6d | Manifold Connection | 160 |
| Figure 13.6e | Air Relief with Schrader Valve | 161 |
| Figure 13.6f | Headworks | 161 |
| Figure 13.6g | Disinfection Unit | 163 |

Section 14 Non-Standard and/or Commercial OWTS Operational Permits

Section 15 Vesting Certificates

| | | |
|------|------------------------|-----|
| 15.1 | General | 168 |
| 15.2 | Term Limitations | 168 |
| 15.3 | Prohibitions | 169 |
| 15.4 | Revocation | 169 |

Section 16 Land Use Entitlement Projects

Section 17 Variance Requirements

| | | |
|------|-------------------------|-----|
| 17.1 | Variance Requests | 171 |
|------|-------------------------|-----|

Section 18 Variance Prohibitions and Special Standards Areas

| | | |
|-----------|--------------------------------------|-----|
| Map 18.1 | Camp Meeker | 174 |
| Map 18.2 | Canon Manor | 175 |
| Map 18.3a | Carmet | 176 |
| Map 18.3b | Rancho del Paradiso | 177 |
| Map 18.3c | Salmon Creek | 178 |
| Map 18.3d | Sereno del Mar/Gleason's Beach | 179 |
| Map 18.3e | Jenner | 180 |

| | | |
|-----------|-----------------------------|-----|
| Map 18.4 | Happy Acres..... | 181 |
| Map 18.5 | Monte Rio..... | 182 |
| Map 18.6 | Penngrove/South Cotati..... | 183 |
| Map 18.7 | West Petaluma..... | 184 |
| Map 18.8 | Russian River Meadows..... | 185 |
| Map 18.9 | South Wright Road..... | 186 |
| Map 18.10 | Thomas Larkin Woods..... | 187 |
| Map 18.11 | Westvue Meadows..... | 188 |

Section 19 OWTS Policy Tier 3, Total Maximum Daily Load and Advanced Protection Management Program

| | | |
|-------------|--|-----|
| 19 | State OWTS Policy Tier 3..... | 189 |
| 19.1 | Advanced Protection Management Program for the Russian River..... | 189 |
| 19.2 | Advanced Protection Management Program for the Petaluma River..... | 193 |
| 19.3 | Advanced Protection Management Program for the Sonoma Creek..... | 196 |
| Table 19.1A | Supplemental Treatment Exemptions..... | 191 |
| Table 19.1B | State OWTS Policy Table 3..... | 192 |
| Map 19.1 | Russian River APMP Boundary..... | 190 |
| Map 19.2 | Petaluma River APMP Boundary..... | 195 |
| Map 19.3 | Sonoma Creek APMP Boundary..... | 197 |

Section 20 Tier 4 – Corrective Action

| | | |
|------|--|-----|
| 20.1 | Conditions..... | 198 |
| 20.2 | Options for Corrective Actions..... | 198 |
| 20.3 | Cesspool Conversion..... | 198 |
| 20.4 | Substantial Conforming OWTS Process..... | 199 |

Section 21 Waterless Toilets

| | | |
|------|----------------------------|-----|
| 21.1 | Purpose..... | 201 |
| 21.2 | Use Standards..... | 201 |
| 21.3 | Development Standards..... | 201 |
| 21.4 | Administration..... | 203 |

Section 22 Waste Discharges Not Authorized by the SWRCB OWTS Policy

| | | |
|------|---|-----|
| 22.1 | Advanced Protection Management Program for the Russian River..... | 204 |
| 22.2 | Non-domestic Waste Not Subject to the SWRCB OWTS Policy..... | 205 |

Section 1 General

1.1 Purpose

- A. The *OWTS Manual* amends in its entirety the *Regulations for Onsite Sewage Dispersal in Sonoma County (November 2002 et seq.)* and is intended to establish conformity with standards for the permit approval, installation, and operation of OWTS within the unincorporated County and within the cities of Sonoma County. Modifications to County OWTS standards are necessary to update, add and/or replace outdated County regulations and to comply with the State Water Resources Control Board (SWRCB) *OWTS Policy*. These standards are adopted to address the potential creation of health hazards and nuisance conditions, to protect the quality of surface water and groundwater in Sonoma County, and to meet provisions of **Tier 2 Local Area Management Program (LAMP)** requirements of the *OWTS Policy*.

1.2 Authority

- A. This *OWTS Manual* provides the regulatory requirements, policy, procedural and technical details for implementation of the Porter Cologne Water Quality Control Act (California Water Code Section 13000 et seq.), the SWRQB *OWTS Policy*, and applicable sections of Sonoma County Code Chapters 7 and 24. The California Water Code 13282 authorizes counties to adopt and enforce regulations, conditions, restrictions, and limitations regarding the dispersal of waste. The SWRQB *OWTS Policy* authorizes the Regional Water Quality Control Board (RWQCB) to approve a LAMP for the implementation of the OWTS Policy. The Sonoma County Code Chapter 24-31.5 authorizes the Permit Authority Director to adopt and promulgate standards for OWTS.

1.3 Applicability

- A. These standards apply to OWTS, where there is a proposed or existing residence, a place of business or other building or place which people occupy, or where persons congregate, reside or are employed and where the maximum daily flow rate of wastewater produced is 10,000 gallons per day or less. The permit requirements in this OWTS Manual shall apply to all OWTS subject to the provisions of this OWTS Manual, unless exempted from permit requirements by Section 4.10. The standards in this OWTS Manual shall apply to all OWTS or OWTS components subject to the provisions of this chapter, regardless of whether a permit is required by this OWTS Manual.
- B. Additionally, review and approval by the RWQCB is required for OWTS in cases where:
1. The maximum wastewater flow rate handled by the OWTS is more than 10,000 gallons per day;
 2. The OWTS is a community system that has a maximum flow rate more than 10,000 gallons per day;
 3. The OWTS receives high-strength wastewater, unless the waste stream is from a commercial food service building;
 4. The OWTS receives wastewater from a commercial food service building:
 - a. with a BOD higher than 900 milligrams per liter, or
 - b. that does not have a properly sized and functioning oil/grease interceptor;
 5. The RWQCB asserts jurisdiction.

Section 2 Sewer Connection Required

- A. Installation of a new or replacement dispersal system OWTS where public sewer is available is prohibited, except as follows:
1. This provision does not apply to replacement OWTS where the connection fees and construction costs are greater than twice the total cost of the replacement OWTS and the local agency determines that the discharge from the OWTS will not affect groundwater or surface water to a degree that makes it unfit for drinking or other uses.
- B. Sewer is available if:
1. The subject parcel is within a sanitation district boundary; and
 2. A public sewer is 200 feet, or the distance specified by the respective sanitation district, or less from the proposed or existing structure; or
 3. A lateral sewer connected to a public sewer is 200 feet, or the distance specified by the respective sanitation district, or less from the proposed or existing structure.

Section 3 Acronyms and Definitions

3.1 Acronyms

APMP means Advanced Protection Management Program.

ASTM means ASTM International (a.k.a. American Society for Testing and Materials), a not for profit, non-governmental organization that develops and publishes technical standards and procedures for testing and classification of materials.

BTU British Thermal Units

BOD means Biochemical Oxygen Demand.

CBC means California Building Code.

CPC means California Plumbing Code.

CTD means Combined Treatment and Dispersal System.

EPA means the U.S. Environmental Protection Agency.

FOG means Fats, Oil, and Grease.

GPD means gallons per day.

IAPMO means the International Association of Plumbing and Mechanical Officials.

LAMP means Local Area Management Program.

MPI means minutes per inch.

NAWT means National Association of Wastewater Technicians.

NSF means NSF International (a.k.a. National Sanitation Foundation), a not for profit, non-governmental organization that develops health and safety standards and performs product certification.

OWTS means Onsite Wastewater Treatment System(s).

RCE means a California Registered Civil Engineer.

REHS means a California Registered Environmental Health Specialist.

RWQCB means the Regional Water Quality Control Board.

STEG means Septic Tank Effluent Gravity.

STEP means Septic Tank Effluent Pump.

SWRCB means the State Water Resources Control Board.

TMDL means Total Maximum Daily Load.

TSS means Total Suspended Solids.

USDA means the U.S. Department of Agricultural.

WT means Waterless Toilet.

3.2 Definitions

Absorption Area is the area(s) of the OWTS dispersal system where wastewater is distributed subsurface for the purposes of final treatment and dispersal. Absorption area is also known as leachfield, drain field or dispersal area.

Accessory Structure is a residential structure not greater than 3,000 square feet in floor area, and not over two stories in height, the use of which is customarily accessory to and incidental to that of the dwelling(s) and which is located on the same lot.

Addition is an increase in living area square footage to the primary residential dwelling or commercial structure and/or any and all accessory structure(s) either through an expansion of the footprint of the dwelling(s) or structure(s), a second floor addition, a basement addition or the conversion of non-habitable space to habitable or living area use. For the purpose of this OWTS Manual, a new residential accessory structure will be considered an “Addition” to the primary residential dwelling.

Adjusting Valve is a device(s) used in OWTS to distribute wastewater in a balanced or even flow.

Administrative Authority. See Permit Authority.

Advanced Protection Management Program Area means the geographical area detailed within the action plan for the named watershed’s pathogen total maximum daily load.

Advanced Treatment is an approved measure that utilizes special designs and/or additional technology to treat the effluent to a much higher level than a conventional system. An approved Advanced Treatment measure shall reduce BOD and TSS to less than 30 milligrams per liter and provide at least 50 percent total nitrogen removal, as verified by an approved independent testing laboratory. Also see Pretreatment.

As-built plans are plans or drawings that depict the final installed configuration of an OWTS system and/or system components. The plans or drawings shall indicate any construction deviations from the approved design and show all features as actually built. The plans or drawings are intended to provide a permanent record of as-built conditions and aid as key references for future maintenance and operations.

At-grade system is an OWTS dispersal system with a discharge point located at the preconstruction grade (ground surface elevation). The discharge from an at-grade system is always subsurface.

Bedrock is the rock, usually solid, that underlies soil or other unconsolidated, surficial material.

Bedroom is any living space in a dwelling unit or accessory structure which is 70 square feet or greater in size and which is located along an exterior wall, but not including the following: hall, bathroom, kitchen, living room (maximum of one per dwelling unit), family room (maximum of one per dwelling unit), laundry room, closet/dressing room, opening off of a bedroom. (Permit Sonoma Policy and Procedure Number 1-4-1, *Definition of Bedroom*).

Bulk Density is the mass of dry soil per unit bulk volume, expressed in grams per cubic centimeter.

The bulk volume is determined before drying to a constant weight at a temperature of 105 degrees.

Bulk Density Analysis is the laboratory analysis of a soil ped taken from a soil horizon within a profile pit to determine the density (mass per unit volume of undisturbed soil expressed in g/cc). This test is performed when a soil horizon reveals suitable soil texture but with a massive structure or extremely firm consistency that may still be septic suitable. Bulk density is inversely related to the soil porosity or void spaces in a sample. The bulk density is used to determine if adjustments are required to the hydrometer results plotted on the Soil Percolation Suitability Chart for OWTS (Figure 7.4). In the North Coast Basin Bulk Density >1.7 g/cc requires a shift in soil textural classification.

Cesspool is an excavation in the ground receiving domestic wastewater designed to retain the organic matter and solids while allowing the liquids to seep into the soil. Cesspools differ from seepage pits because cesspool systems do not have septic tanks. The term cesspool does not include pit-prives or out-houses.

Clay is mineral soil particles less than 0.002 millimeters in diameter. As a texture, clay is identified in the USDA Soils Classification Triangle as a soil material that is 40 percent or more clay, less than 45 percent sand, and less than 40 percent silt.

Class 2 Permeable Material means crushed rock or gravel, durable and free from slaking or decomposition under the action of alternate wetting or drying, uniformly graded, and shall meet the requirements of the Caltrans Standard Specifications, Section 68-2.02F(3).

Clothes Washer Graywater System is a graywater system utilizing only a single domestic clothes washing machine in a one or two family dwelling that does not include a cross-connected potable water connection or a pump and does not affect other building, plumbing, electrical, or mechanical components including structural features, egress, fire-life safety, sanitation, potable water supply piping, or accessibility.

Coarse Fragment is rock or mineral particles greater than 2.0 millimeters in diameter.

Cobbles are rock fragments 76 millimeters or larger using the USDA soils classification systems.

Community System is an OWTS that accepts wastewater from buildings or structures on two or more parcels or an OWTS shared by buildings or structures under separate ownership whether or not they are on the same Parcel. A community OWTS may be either privately or publicly owned or operated.

Complex Graywater System is a residential graywater system that discharges over 250 gallons per day.

Conditioned Space is any area, room or space in a building being heated exceeding ten BTUs per hour-square foot or cooled exceeding five BTUs per hour-square foot directly or indirectly by any equipment or passive design feature for the comfort of occupants or for other reasons such as preserving temperature-sensitive goods.

Cumulative Effects are the persistent and/or increasing effects of individual OWTS resulting from the density of such discharges in relation to the assimilative capacity of the ground environment. Examples include salt or nitrate additions to groundwater, nutrient enrichment of surface water, and hydraulic interference with groundwater and between adjacent systems.

Cut Bank is a man-made excavation of the natural terrain in excess of three feet. Cuts supported by retaining walls or similar structures shall be included within this definition, as shall steep natural ground surfaces where a sharp break in the ground slope is discernible.

Developed Site means a parcel of land with an existing structure or an existing use that produces

domestic wastewater.

Dispersal System is a leachfield, seepage pit, mound, at-grade, subsurface drip field, evapotranspiration and infiltration bed, bottomless sand filter, sand fill trench, or other type of system for final wastewater treatment and subsurface discharge.

Domestic Wastewater is wastewater with a measured strength less than high-strength wastewater and is the type of wastewater normally discharged from, or similar to, that discharged from plumbing fixtures, appliances and other household devices including, but not limited to toilets, bathtubs, showers, laundry facilities, dishwashing facilities, and garbage disposals. Domestic wastewater may include wastewater from commercial building such as office buildings, retail stores, and some restaurants, or from industrial facilities where the domestic wastewater is segregated from the industrial wastewater. Domestic wastewater may include incidental RV holding tank dumping but does not include wastewater consisting of a significant portion of RV holding tank wastewater such as at RV dump stations. Domestic wastewater does not include wastewater from industrial processes.

Downslope Property Line is a property line down-gradient from the proposed OWTS.

Drain field or Leachfield is a system of rock-filled trenches also known as leachlines and/or disposal lines, or beds or infiltration chambers that distribute treated sewage effluent for absorption into the soil.

Dual Drain Field is an effluent dispersal system consisting of two primary drain fields, each designed to a minimum of ≥ 75 percent of total design flow, connected by an accessible diversion valve and intended for alternating use on an annual or semiannual basis.

Effective Drain Field Depth is the depth of drain rock below the bottom of the drain field pipe.

Effluent is sewage, water, or other liquid, partially or completely treated or in its natural state, flowing out of a septic tank, aerobic treatment unit, dispersal system, or other OWTS component.

Encumbrance means any physical structure or manmade object (buildings, driveways, storm drainage systems, cut banks, fill placement, disturbed areas, water wells), any natural or geologic feature (over steepened slope, landslide, rock outcropping, waterbodies), easements or regulation that prevents the use of a land area for the design or construction of an OWTS. The parentheticals are examples only and are not inclusive.

Enhanced Effluent Dispersal System means any system type that uses a pressurized distribution system for dosing and/or even distribution of the effluent throughout the dispersal system. System types include, but are not limited to Pressure Distribution OWTS, Gravel-less Pressurized Dispersal Channel OWTS, Mound OWTS, At-Grade OWTS, Shallow In Ground OWTS, and Drip Dispersal OWTS.

Expansion Area. See Reserve Replacement Area.

Field Clearance is a site visit required when Permit Sonoma's file information is not sufficient to show that the proposed work will not adversely impact the OWTS. A field clearance is more often needed when an older OWTS predates Permit Sonoma's record keeping system. In addition, when there is a lack of information on file for the OWTS, a site visit is necessary to verify that an approved OWTS exists on the property.

Findings Report is an analysis of the OWTS which includes review of Permit Sonoma septic file information and a visual inspection of an existing OWTS and/or well for the purpose of providing potential buyers or interested parties with information regarding a particular septic system or well. A Findings Report may be prepared by Permit Sonoma staff, an RCE, or a REHS.

French Drain. See Intercept Drain.

Graywater is untreated wastewater that has not been contaminated by any toilet discharge, has not been affected by infectious, contaminated, or unhealthy bodily wastes, and does not present a threat from contamination by unhealthful processing, manufacturing, or operating wastes. “Graywater” includes, but is not limited to, wastewater from bathtubs, showers, bathroom washbasins, clothes washing machines, and laundry tubs, but does not include wastewater from kitchen sinks or dishwashers.

Graywater System is a system designed to collect graywater and transport it out of the structure for distribution in an irrigation or dispersal field. A graywater system may include tanks, valves, filters, pumps or other appurtenances along with piping and receiving landscape.

Groundwater is water located beneath the ground surface in soil pore spaces or in the fractures of lithologic formations. Groundwater may be present only seasonally (perched). A unit of rock or unconsolidated deposit is called an aquifer when it can yield a usable quantity of water.

Hardpan is an irreversibly hardened soil layer caused by the cementation of soil particles. The cementing agent may be silica, calcium carbonate, iron or organic matter.

Health Officer refers to the Sonoma County Health Officer or his/her designated representatives, for purposes of implementation of these standards; the Director of Permit Sonoma is the delegated representative.

High Strength Wastewater is wastewater having a 30-day average concentration of BOD greater than 300 milligrams per liter or of TSS greater than 330 milligrams per liter or a FOG concentration greater than 100 milligrams per liter prior to the septic tank or other OWTS treatment component.

Holding Tank is a watertight receptacle used to collect and store wastewater prior to it being removed from a property by means of vacuum pumping and hauling. The use of holding tanks is authorized for limited circumstances, including, but not limited to, for the abatement of health hazards or for certain public use facilities.

Hydrometer Analysis is a test used to determine the grain size distribution of soils passing the number 200 sieve (ASTM D 7928-17).

Impaired water bodies are those surface water bodies or segments thereof that are identified on a list approved first by the SWRCB and then approved by the EPA pursuant to Section 303(d) of the Federal Clean Water Act.

Impermeable Soil Layer is any layer of soil having a percolation rate slower than 120 minutes per inch at the bottom of the proposed dispersal area or having a Plasticity Index of greater than 20, ASTM D 4318-84.

Incompatible Use is any activity or land uses that would preclude or damage an area for future use as an effluent dispersal site, including the construction of buildings, roads, or other permanent structures and activities that may result in the permanent compaction or removal of existing soil.

Interior Remodel is improvement to the interior of the structure with no removal and/or replacement of the structure.

Intercept Drain is a trench filled with drain rock that is designed to intercept and divert ambient groundwater with surface discharge via piping to another location. Intercept drains are typically used to dewater areas upslope of a leachfield or a foundation and lower the water table. Intercept drains are also known as French drain or curtain drain.

Land Encumbrance is the land area that is eliminated from being utilized for septic dispersal areas.

Examples of encumbrances are existing or proposed impervious surfaces such as structures, driveways, paved areas or other hard surfaces, as well as regulatory requirements or easements that eliminate land area for septic dispersal such as setbacks from creeks, rivers, riparian corridors, cut slopes, geological hazards, septic systems, wells, etc.

Leachfield. See Drain field.

Limiting Condition is the portion of the soil profile that because of percolation characteristics most restricts the successful operation of a drain field. A limiting condition would include but not be limited to impermeable soil, semi-permeable soil, expansive clay, fractured rock, consolidated rock, excessive rock content and perched or seasonal elevated groundwater conditions.

Linear Loading Rate is defined as the amount of effluent in gallons applied per day per linear foot of the system. The design linear loading rate is a function of the rate of effluent movement and the direction of movement away from the OWTS (horizontal, vertical or combination).

Living Area includes all areas of residential dwellings and residential accessory structures including bathrooms, kitchens, closets, utility rooms, hallways and any other area in a building that is designed for human use. New residential rooms above garages and/or other new residential accessory structures on the property will be considered living areas. Areas such as unfinished attic space, unfinished basements, and garages are not considered living areas. (Section 6: OWTS Requirements for Approval of Building Permits)

Local Agency is any subdivision of the state government that has responsibility for permitting the installation of and regulating OWTS within its jurisdiction boundaries typically a county, city or special district.

Maintenance of a wastewater treatment system shall mean clearing of stoppages in pipes without removing, replacing, or rearranging the pipes or surrounding soils; repairing or replacing non-treatment components of a wastewater system; pumping liquid and solids from, or otherwise cleaning septic tanks and grease interceptors; cleaning sand filters; and cleaning pressure distribution system pumps and piping.

Modification is a remodel or addition of living area (potentially habitable or not) to an existing structure.

Monitoring Wells are installed to monitor groundwater. The construction of monitoring wells must meet California Well Standards and be installed under permit by the State of California or the designated enforcement agency. Monitoring wells are not to be confused with performance wells used to evaluate the efficacy of OWTS in the immediate area. See Performance Wells definition.

Mottling is a soil condition that results from oxidizing or reducing minerals due to soil moisture changes from saturated to unsaturated over time. Mottling is characterized by spots or blotches of different colors or shades of color (grays and reds) and size interspersed within the dominant color as described by the USDA soil classification system. The soil condition can be indicative of historic seasonal high groundwater level, but the lack of this condition may not demonstrate the absence of groundwater. Mottling in soils usually indicates poor aeration, periodic saturation, or poor drainage.

Mound System is an aboveground dispersal system (covered sand bed with effluent leachfield elevated above original ground surface inside) used to enhance soil treatment, dispersal, and absorption of effluent discharged from an OWTS treatment unit such as a septic tank. Mound systems have a subsurface discharge.

Occupancy is the classification of a structure as defined in the CBC, which is given based on the intended use and/or designed use of such structure. See CBC Chapter 3.

Office Clearance is a review of Permit Sonoma files and application documents in the office to determine that the proposed work will not impact the existing OWTS.

Operational Permit is a renewable and revocable permit to operate and maintain a non-standard experimental or ~~alternative~~ an OWTS with supplemental treatment.

Onsite Wastewater Treatment System(s) (OWTS) is an individual dispersal system, community collection and dispersal systems, and alternative collection and dispersal systems that use subsurface dispersal. The short form of the term may be singular or plural. OWTS do not include “graywater” systems pursuant to the Health and Safety Code Section 17922.12. Commonly referred to as septic system(s).

OWTS, Alternative is an approved non-standard OWTS that has demonstrated in the non-standard Experimental phase to function in such a manner as to protect water quality and preclude health hazards and nuisance conditions and is capable of producing an equal to or greater quality wastewater effluent and improved performance of and siting for effluent dispersal than a standard OWTS.

OWTS, Code Compliant is a system that is in conformance with this OWTS Manual. A Code Complaint OWTS can be new or existing.

OWTS, Commercial is an OWTS that serves a facility or structure whose occupants are engaged in the buying or selling of goods or services or that serves a facility or structure which is a non-residential occupancy.

OWTS, Community System is an OWTS that accepts wastewater from buildings or structures on two or more parcels or an OWTS shared by buildings or structures under separate ownership whether or not they are on the same Parcel. A community OWTS may be either privately or publicly owned or operated.

OWTS, Experimental is a non-standard OWTS deemed conditionally acceptable by the RWQCB, subject to increased performance monitoring and evaluation, prior to acceptance as an approved non-standard Alternative OWTS.

OWTS, New is an OWTS proposed for construction in compliance with this OWTS Manual.

OWTS, Non-Conforming is an OWTS that has a septic tank and dispersal system and was in compliance with the septic laws, regulations or codes when constructed and which is not in compliance with this OWTS Manual. OWTS constructed prior to OWTS regulations may be considered Non-Conforming OWTS.

OWTS, Non-Standard is a type of OWTS that utilizes a method of wastewater treatment that may or may not include a conventional septic tank and/or method of wastewater dispersal other than a conventional drain field for the purpose of producing an equal to or greater quality wastewater effluent and improved performance of and siting for effluent dispersal than a standard OWTS. There are two types of non-standard systems. See Alternative OWTS and Experimental OWTS.

OWTS, Repair is an OWTS that is operating marginally or the system or a system component has failed. A “repair” would require a component(s) replacement and/or re-building to make corrections so the OWTS operates as it was originally designed.

OWTS, Replacement is an OWTS that has its treatment capacity expanded, or its dispersal system added onto or replaced.

OWTS, Standard is a type of OWTS consisting of a septic tank for primary treatment of sewage, followed by a system of drain field trenches for subsurface dispersal of effluent into the soil. A standard

OWTS may utilize gravity flow or a pump system to convey effluent from the septic tank to the drain field.

OWTS Application is an OWTS design application or an OWTS construction application filed with the Permit Authority to verify compliance with this OWTS Manual.

OWTS Construction Application is an application filed with the Permit Authority for the purpose of constructing an OWTS by pursuing either a permit or a vesting certificate.

OWTS Design Application is an application filed with the Permit Authority for the purpose of demonstrating a potential OWTS type and location but not for construction.

OWTS Failure is when effluent is surfacing or sewage is backing up into plumbing fixtures due to the inability of the disposal field to accept and absorb effluent into the soil.

OWTS Policy is the California State Water Resources Control Board Water Quality Control Policy for Siting, Design, Operation, and Maintenance of Onsite Wastewater Treatment Systems.

Package Treatment Plant is a method of sewage treatment that includes flows greater than 1,500 gallons per day; wastewater used for Title 22 purposes and does not include process wastewater from agricultural sources, etc., unless there is a domestic component. A package treatment plant uses a process involving energy and mechanical, biological, chemical or physical treatment of the wastewater to reduce the BOD, suspended solids, Nitrogen, bacteria and other sewage constituents and which is of a degree of complexity that a certified wastewater treatment plant operator or approved OWTS Service Provider is required.

Percolation Test is a test conducted to determine the permeability or percolation quality of the soil in an area proposed for sewage dispersal.

Performance Wells are installed in and around an OWTS to monitor the performance of the system. Performance wells are a component of the OWTS with the design and construction meeting County standards.

Permit Authority is the state or local unit of government with the statutory or delegated authority to issue permits to build and operate OWTS.

Permit Sonoma is the Sonoma County Permit and Resource Management Department.

Post-Construction Storm Water Treatment Facility means a structural best management practice to retain, detain, infiltrate and/or treat storm water runoff. These facilities are specifically designed for post-construction applications and remain on the landscape after construction has been completed. Examples include wet ponds, dry basins, multi-chamber catch basins, infiltration basins/trenches, dry wells, porous pavement, grassy swales, filter strips, artificial wetlands and rain gardens. This definition does not include active construction storm water best management practices such as straw wattles, silt fences, silt basins or similar practices typically used during construction.

Pressure Dosing is the uniform application of wastewater under pressure. Wastewater is applied under pressure uniformly on an intermittent basis in the dispersal field through the use of a sump and pump. Pressure dosing is also done in the application of wastewater in supplemental treatment processes.

Pretreatment of wastewater is to reduce five-day BOD, TSS, nitrogen, and/or the total and fecal coliform content to improve the wastewater quality prior to dispersal. Pretreatment is a form of supplemental treatment.

Pretreatment unit or device is an NSF listed and certified and County-approved Advanced Treatment

Unit that provides pretreatment of wastewater.

Public Water System is a water system regulated by the California Department of Public Health or a Local Primacy Agency pursuant to Part 12, Chapter 4, California Safe Drinking Water Act, Section 116275 (h) of the California Health and Safety Code.

Public Water Well is a groundwater well serving a public water system. A spring which is not subject to the California Surface Water Treatment Rule (SWTR), CCR, Title 22, Sections 64650 through 64666 is a public well.

Purge Valves are used in OWTS utilizing pressurized wastewater distribution to aid in the cleaning of laterals. Purge valves are generally placed at the end of each lateral.

Qualified Consultant means an individual licensed or certified by a State of California agency to design OWTS and practice as professionals for other associated reports, as allowed under their license or registration. Depending on the work to be performed and various licensing and registration requirements, this may include an individual who possesses a registered environmental health specialist certificate or is currently licensed as a professional engineer or professional geologist. For the purposes of performing site evaluations, Soil Scientists certified by the Soil Science Society of America are considered qualified professionals.

Qualified Inspector means an individual conducting an inspection for compliance with a Total Maximum Daily Load Implementation Plan and is either a qualified consultant, a service provider certified by an OWTS manufacturer, a licensed contractor, a National Association of Wastewater Technician, the property owner, or County of Sonoma staff as approved by the Permit Sonoma Director.

Reconstruction is 100 percent construction of all elements of the structure, including, but not limited to, roof elements, load-bearing walls, non-bearing walls, and foundations.

Redoximorphic is exhibiting characteristic features (soil mottles or soil mottling) caused by alternating reduction and oxidation of iron and manganese compounds.

Regulatory Authority. See Permit Authority.

Reserve Replacement Area is an unencumbered portion of land that is reserved for the installation of a future OWTS, in the event of primary OWTS failure. The reserve replacement area must be suitable for an OWTS as demonstrated with acceptable percolation testing, groundwater conditions, and adequate depth of soil. Reserve Replacement area is sometimes referred to as expansion area.

Residential is any structure or room labeled "R" occupancy as defined by the CBC.

Rough-in is to install the preliminary (rough) plumbing, electrical and/or mechanical building materials without making the final connections.

Sand is individual rock or mineral fragments in soils having diameters ranging from 0.05 to 2.0 millimeters. Most sand grains consist of quartz, but they may be of any mineral composition. It is classified in the USDA Soils Classification Triangle as a soil material that contains 85 percent or more sand and not more than 10 percent clay.

Saturated Soil is the condition of soil when all available pore space is occupied by water and the soil is unable to accept additional moisture. In very fine textured soils a free water surface may not be apparent. The extent of saturated soil conditions and anticipated level of high groundwater can be estimated by the extent of soil mottling, provided the soils contain the necessary iron compounds to exhibit mottling.

Seepage Pit is an excavation in the ground filled with drain rock which receives the effluent discharge from a septic tank, or OWTS treatment unit, designed to permit the effluent to seep through its bottom and sides. Seepage pits are typically substituted for a leachfield at severely constrained sites serving existing dwellings.

Septic System. See Onsite Wastewater Treatment System.

Septic Tank is a water-tight covered receptacle designed and constructed to receive the discharge of sewage from a building sewer; separate solids from the liquid; digest organic matter; store digested solids through a period of detention and allow the clarified liquids to discharge for final subsurface dispersal.

Service Provider is an RCE, REHS, or any person who is licensed as a "certified onsite wastewater system inspector" or other equivalent license by passing a state or nationally accredited onsite wastewater exam, capable of operating, monitoring, and maintaining an OWTS (for example, NAWT and/or a proprietary unit certification).

Setback is the minimum horizontal distance from any point along the outside edge of a septic tank, or the edge of a dispersal area, to any point on the described site feature.

Sewage ejector pump– is able to pump wastewater having spherical solids measuring around two inches to septic tanks or sewer system by entraining it on a high velocity jet stream, air or water.

Sewage grinder pump – a pump that grinds the sewage and then pumps it from a building into the septic or sewer system.

Sewage pump – a permanently installed mechanical device other than an ejector, for removing sewage or liquid waste from a sump. (CPC)

Sidewall is the wall of a dispersal trench utilized for effluent infiltration with the wall height being measured from the bottom of the dispersal pipe to the bottom of the dispersal trench.

Simple Graywater System is a graywater system serving a one or two family dwelling with a discharge of 250 gallons per day or less. Simple Systems exceed a Clothes Washer Graywater System.

Silt is individual mineral particles in a soil that range in diameter from the upper limit of clay (0.002 millimeter) to the lower limit of very fine sand (0.05 millimeter). It is classified in the USDA Soils Classification Triangle as a soil material that contains 80 percent or more silt and less than 12 percent clay.

Site is the location of the OWTS; is the location of the reserve replacement area(s); is the subject parcel proposed for development.

Site Evaluation is soil profile evaluation, percolation test or groundwater table determination, either individually or collectively.

Site Evaluation Area means the area under consideration for an OWTS including the reserve system(s).

Site Map means a site plan pursuant to the department's requirements and policy.

Soil consists of the natural organic and inorganic material near the earth's surface which is in contrast to the underlying rock material and has been formed over time by the interactions between climate, relief, parent materials, and living organisms.

Soil Consistence is the degree and kind of cohesion and adhesion that soil exhibits and/or the resistance of soil.

Soil Depth is the combined thickness of adjacent soil layers which are suitable for effluent filtration. Soil depth is measured vertically to bedrock, hardpan, or an impermeable soil layer.

Soil Horizon or Layer is a layer of soil approximately parallel to the land surface and differing from adjacent (underlying or overlying) layers in some property or characteristic. Differences in soil characteristics include but are not limited to, color, texture, structure and porosity.

Soil Profile is a vertical section of the soil that depicts all its horizons or is a soil evaluation field study where the soil texture, shape, grade, consistence and soil horizon(s) are determined.

Soil Structure refers to the aggregation of soil particles, sand, silt and clay into larger soil units called peds. The structure of the soil is generally described in the following terms: Shape/Type (platy, blocky, prismatic, massive, single grain/granular, columnar, wedge or lenticular), Size (very fine, fine, medium, coarse, very coarse or extremely coarse) Grade (structureless—zero, weak—one, moderate—two, strong—three).

Soil Survey is a general term for the systematic examination of soils in the field and in the laboratory. This would include the soil description and classification, the mapping of kinds of soil, and the interpretation of soils for many uses such as suitability for growing various crops, grasses, and trees, for engineering uses, and predicting the soil behavior under different management systems. Most notable and common reference used is the USDA National Resources Conservation Service Soil Survey.

Soil Texture is the relative proportions of sand, silt, and clay as defined by the classes of the USDA soil textural triangle. Textural classes may be modified when coarse fragments are present in sufficient number or when the bulk density is excessive.

Soil Texture Hydrometer Analysis is a laboratory test to determine the percent sand silt and clay in a field collected soil sample from soil horizons. The hydrometer test results are plotted to the USDA soil textural triangle to arrive at soil textural classification (see Figure 7.4).

Storm Water Treatment Facility, Post Construction see Post Construction Storm Water Treatment Facility.

Stream, Ephemeral Watercourse is a stream or reach of a stream that flows briefly only in response to precipitation in the immediate locality and whose channel is at all times higher than the water table. Any water course that does not meet this definition is to be considered a perennial or intermittent stream for the purposes of the chapter.

Stream, Intermittent is a stream that ceases to flow occasionally or seasonally because of evaporation and leakage. See Perennial Stream.

Stream, Perennial is any stretch of a stream that can be expected to flow continuously or seasonally (Intermittent). Perennial streams are generally fed in part by springs and appear on US Geological Survey maps as a solid blue line. A perennial stream may include an intermittent stream which is a USGS designated blue line dashed stream that ceases to flow occasionally or seasonally because of evaporation and leakage.

Stream means any natural channel with bed and banks containing flowing water or showing evidence of having contained flowing water, such as deposit of rock, sand, gravel, or soil. Stream includes creeks, rivers and non-mapped streams.

Structure is that which is built or constructed.

Sump is a tank that collects treated sewage for a period of time and periodically the timer or sensor will discharge the sewage by means of a pump to the disposal field. “Sump basin”, “sump tank”, “pump tank”, are terms used to refer to a sump.

Supplemental Treatment Unit means any OWTS or component of an OWTS, except a septic tank or dosing tank, that is NSF listed and certified which performs additional treatment of domestic wastewater to decrease the constituents of concern before they reach primary treatment components or the final effluent dispersal field. Supplemental treatment units encompass pretreatment units. Pretreatment units are also referred to as supplemental treatment units.

Swale means a natural shallow channel with gently sloping sides and no distinct bed or banks.

Toilet, Composting is a self-contained waterless toilet designed to decompose non water- carried human wastes through microbial action on a carbon source and store the resulting matter for further treatment and reuse/disposal. See Waterless Toilet.

Toilet, Flush is a toilet consisting of a bowl for receiving human waste and a water-flushing device.

Toilet, Waterless is a toilet specifically designed to receive non-water-carried human waste; includes composting, incinerator, pit, chemical & vault toilets.

Toilet, Vault is a waterless toilet mounted on a vented holding tank designed to store non-water-carried human waste prior to offsite treatment.

Topographic Map is a map showing the features of a land surface, commonly by means of contour lines. It is generally on a sufficiently large scale to show in detail selected man-made and natural features, including relief and physical and cultural features such as vegetation, roads, and drainage.

Unfinished Structure is any structure, or any part of a structure, with exposed studs, and no insulation or sheet rock covering the walls. Unfinished rooms in a primary dwelling and/or residential accessory structure shall have exterior access doors only with no direct access to the interior of a primary dwelling and/or residential accessory structure.

Unstable Landform is an area that shows evidence of mass downslope movement such as debris flow, landslides, rockfalls, and hummocky hill slopes with undrained depressions upslope. Unstable landforms may exhibit slip surfaces roughly parallel to the hillside; landslide scars and curving debris ridges; fences, trees, and telephone poles which appear tilted; or tree trunks which bend uniformly as they enter the ground.

Watercourse is a definite open channel with bed and banks within which water flows either perennially or intermittently, including overflow channels contiguous to the main channel. A watercourse shall include both natural and man-made channels.

Section 4 Criteria for All OWTS

4.1 Purpose of OWTS

- A. New and replacement OWTS shall be located, designed, constructed, and operated in a manner to ensure that sewage effluent does not surface at any time, that is protective of public health, safety and the environment and that percolation of effluent into the soil will not adversely affect beneficial uses of the waters of the State of California.
- B. New and replacement OWTS and the repair of an OWTS shall comply with the requirements of this OWTS Manual.

4.2 OWTS Sizing Criteria Wastewater Flows

- A. Residential wastewater flows used for design of OWTS for new single family residences, second units, guest houses and other detached buildings shall be based on the number of bedrooms multiplied by a factor of 120 gallons per day per bedroom for the first five bedrooms, plus 60 gallons per day for each additional bedroom, as indicated in Table 4.2.
- B. The design flows for a primary residence and detached accessory structures (second unit and/or guest house) shall be determined independently, regardless of whether the flows are treated separately or combined in a single OWTS.

Table 4.2
Wastewater Design Flows for
Single Family Residences and Second Unit

| Number of Bedrooms | Design Flow (gallons per day) |
|--------------------|-------------------------------|
| 1 | 120 |
| 2 | 240 |
| 3 | 360 |
| 4 | 480 |
| 5 | 600 |
| greater than 5 | + 60 per bedroom |

- C. Wastewater flows used for the design of OWTS for multiunit residences and non-residential projects shall be developed based on full consideration of projected activities, occupancy, and facilities. Table 11.1 provides guidelines for use in estimating design wastewater flows. Wastewater flows shall be determined by:
 - 1. Table 11.1 for those listed facilities; or
 - 2. Appropriate literature references (for example US/EPA) for the type of facility proposed; or
 - 3. Documented wastewater flow monitoring data for a comparable facility. Additionally, the Director of the Permit Authority may consider adjustment to the criteria listed in Table 11.1 for specific facilities based upon documented technical information to support the proposed design flow estimate.
- D. Reductions of wastewater design flows up to 20 percent for dwelling units constructed prior to

1998 shall be approved by the Permit Authority Well and Septic Section when each of the following is provided low flow devices for toilets, showers and faucets are installed in the structure under permit. :

4.3 Requirement for OWTS Reserve Replacement Area

The California Plumbing Code (CPC) requires that a site cannot be developed beyond its capacity to properly absorb sewage effluent. The CPC also requires that no structure shall be erected on a lot where the structure impairs the usefulness of the 100 percent expansion area. Though the CPC requires 100 percent expansion area, Sonoma County adopted stricter standards in October 1971, requiring 200 percent expansion area.

In addition to an approved primary OWTS system design to serve the structure(s), the reserve replacement area must be suitable for an OWTS in compliance with the OWTS Manual.

- A. Reserve Replacement Area is required as outlined below and in Section 6.6.
- B. The size of the Reserve Replacement Area shall be designed in accordance with the provisions below.
 - 1. Parcels created prior to October 1971 require 100 percent replacement area;
 - 2. Parcels created in October 1971 or later require 200 percent replacement area;
 - 3. In a dual dispersal field system, a portion of the replacement area is constructed with the primary system. Any percentage of the required reserve (4.3.B.1 or 4.3.B.2) not constructed as part of a dual field system shall be designated as reserve replacement area;
 - 4. Commercial, industrial and institutional developments require 200 percent replacement area.
- C. OWTS construction within an existing designated reserve replacement area shall comply with the following:
 - 1. A new OWTS may be permitted in the designated reserve replacement area for the existing structure based on the original approved permitted OWTS design.
 - 2. The original reserve replacement area must have complied with site evaluation criteria for the system type being proposed.
 - 3. Constructing a new OWTS within a designed reserve replacement area does not require an additional reserve replacement area.
 - 4. The new OWTS may replace the existing OWTS or it may be constructed as a second system of a dual system allowing the original system to rest.

4.4 OWTS Designer by System Type

- A. The type of OWTS or OWTS components listed in Table 4.4 shall be designed by the corresponding designer.
 - 1. A commercial/institutional, experimental, alternative, or a standard OWTS shall be designed

- by a qualified consultant.
2. A replacement dispersal area or field shall be designed by a qualified consultant.
 3. A replacement septic tank shall be designed by a qualified consultant, ~~or~~ licensed contractor, or homeowner/builder.
 4. A repair shall be designed by a qualified consultant, licensed contractor or homeowner/builder.
 5. A repair or modification of an existing OWTS shall be designed by the professional listed in Table. 4.4.

**Table 4.4
OWTS Designer by System Type**

| Type of System | Designer |
|--|---|
| Commercial/Institutional/Experimental OWTS Alternative OWTS Standard OWTS Replacement Dispersal Area/Field OWTS with Easements | Qualified Consultant |
| Replacement Septic Tank | Qualified Consultant Licensed contractor (A, C- 42, C-36) Homeowner/builder |
| Repair | Qualified Consultant Licensed contractor (A, C- 42, C-36) Homeowner/builder |

4.5 OWTS Locations and Off-Site Easements

- A. OWTS shall be constructed, or designed to be placed, on the same legal parcel containing the structure(s) intended to be served by the OWTS.
- B. If an OWTS does not comply with 4.5.A then legal access to adjacent parcels may be established through a lot line adjustment or parcel merger.
- C. If an OWTS does not comply with 4.5.A and 4.5.B then legal access to adjacent parcels shall be established through an easement.
- D. Easements shall be recorded with the County Recorder’s office in a form acceptable to CountyCounsel and the Permit Authority, and shall include:

1. A Grant Deed conveying the easement from the record owners of the burdened parcel to the owners of the parcel to be developed; and
 2. A full legal description and a plat of the easement area prepared by a Licensed Land Surveyor or a RCE whose registration allows surveying; and
 3. All appurtenant easements for access, pipelines, drainage, etc. shall be conveyed in the grant deed; and
 4. Conditions, Covenants, and Restrictions recorded on the deed as follows:
 - a. A statement that the easement shall bind and inure to the benefit of the respective heirs, personal representatives, successors, and assigns of the grantor and grantee and that all specifications of the easement shall pertain to and run with the land;
 - b. A statement that provision of the easement is a public health condition relative to approval of an OWTS permit and that alteration or elimination of the rights and duties without the express written consent of the County of Sonoma may constitute a violation of State and local laws;
 - c. The use of the area of the dispersal field easement by the grantor shall be restricted from uses which are compatible with proper dispersal field operation. This shall include structures, vehicular parking, roadways, grading, drainage courses, wells, extensive landscaping, confined livestock or other uses which would disrupt the dispersal field;
 - d. The easement shall include the right of the grantee to do all things reasonably necessary to inspect, maintain, repair and/or replace the dispersal field.
 5. The grant deed and/or legal description referenced in Sections 4.5.D.1 and 4.5.D.2 shall be reviewed by the County Surveyor's office prior to permit issuance.
- E. Dispersal field easements shall be separate and distinct from one another.
- F. An OWTS easement shall not encroach into an area needed for the grantor's parcel OWTS and/or reserve replacement area.
- A. The area necessary for the grantor's parcel OWTS and its reserve replacement area shall be based upon codes in effect at the time of the grantee parcel's OWTS easement application.
 - B. The grantor's parcel OWTS does not need to be modified unless it is in a state of failure.
 - C. Prior to issuing construction permits for the grantee's OWTS on the grantor's property, the following conditions shall be met on the grantor's property:
 - a. For property without an existing OWTS, a primary OWTS and reserve OWTS shall be perfected on the grantor's property pursuant to this OWTS Manual with an OWTS Application and sized to support the minimum level of development for the underlying land use for the grantor parcel's zoning.
 - b. For property with an existing OWTS, the primary OTWS and reserve OWTS on the grantor's property shall be shown on the site map for the grantee's OWTS Application.
- G. Easements for Subdivisions and Lot Line Adjustments shall comply with Section 16.

1. No approval of an application for a minor subdivision or lot line adjustment which necessitates use of sewage easements shall be granted. Each proposed lot must be demonstrated to have a site suitable for installation and expansion of an OWTS contained entirely within the proposed property lines of the lot.
 2. Sewage easements for major subdivisions may be considered under the following circumstances:
 - a. A homeowner's association or other entity of dischargers empowered to conduct a program of regular sewage system monitoring, maintenance, and repair is created.
 - b. Easements are contained only within common lands of the subdivision.
 - c. Common areas are owned and controlled by the homeowner's association or other entity.
 - d. The easement for each lot is entirely separate and distinct from the easement for any other lot.
 - e. Easements shall not be used as a basis to allow lot sizes smaller than those specified in the County Subdivision Ordinance for lots with OWTS.
- H. An easement grant from one property owner to another shall comply with the following:
1. The grantor parcel and grantee parcel must abut each other.
 2. Abutting lots includes a parcel owned in common ownership by the grantor that is not directly abutting the grantee's parcel, provided at least one of the grantor's parcels, in common ownership, abuts the grantee's parcel. One parcel of the grantor's common ownership parcels must be adjacent to the grantee's parcel.
 3. A public road or highway will satisfy the connection between abutting lots, pursuant to section 4.5.J below.
 - ~~5.4.~~ An encroachment permit shall be obtained from the Permit Authority prior to conducting work in a public right-of-way.
- I. For properties in common ownership, a covenant shall be recorded with the County Recorder's office in a form acceptable to County Counsel and the Permit Authority, and shall include:
1. An agreement and covenants running with the Land executed by the property owner of the parcel benefitted and the parcel burdened by the covenant; and
 2. A full legal description and a plat of the burdened area on the parcel burdened by the covenant prepared by a Licensed Land Surveyor or a RCE whose registration allows surveying; and
 3. A statement that the covenant shall bind and inure to the benefit of the respective heirs, personal representatives, successors, and assigns of the property owner and that all specifications of the covenant shall pertain to and run with the land; and
 4. A statement that provision of the covenant is a public health condition relative to approval of an OWTS permit and that alteration or elimination of the rights and duties without the express written consent of the County of Sonoma may constitute a violation of State and

local laws; and

5. A statement that the covenant is appurtenant to the parcel upon which the building needing the OWTS is to be constructed; and
 6. A statement that it is the intent of the property owner that the covenant is intended to survive severance of the estates and to be included in conveyances to subsequent purchasers; and
 7. A statement that the covenant shall not be extinguished or otherwise modified or destroyed without the written consent of the Director of the Permit Authority, which shall not be unreasonably withheld, and
 8. The use of the area of the burdened area by the property owner shall be restricted from uses which are incompatible with proper dispersal field operation. This shall include structures, vehicular parking, roadways, grading, drainage courses, wells, extensive landscaping, confined livestock or other uses which would disrupt the dispersal field.
- J. An easement to traverse a County dedicated right-of-way, such as a public road, shall comply with the following:
1. The proposed traverse shall be as perpendicular as possible to the right-of-way and be the minimum distance needed to install a transmission line between properties on both sides of the right-of-way.
 2. The proposed traverse shall not be parallel with the right-of-way and is intended to cross the right-of-way.
 3. Only OWTS transmission lines shall be allowed to traverse the right-of-way.
 4. The proposed traverse and easement shall be subject to review and approval by the Permit Authority.
 5. An encroachment permit shall be obtained from the Permit Authority prior to conducting work in the right-of-way.
- K. For OWTS subject to Section 14 OWTS Operational Permit and Monitoring, in addition to other parties, easements shall also be in favor of the Permit Authority.

4.6 Prohibitions

- A. The use of holding tanks is prohibited. However, the use of holding tanks may be authorized for limited circumstances as follows:
1. to abate an existing nuisance or health hazard; or
 2. the proposed use is within a sewer service area, sewers are under construction and completion is expected within two years and the sanitation district assumes responsibility for maintenance of the tanks; or
 3. it is for use at a campground or similar temporary public facility where a permanent sewage dispersal system is not necessary or feasible and maintenance is performed by a public agency; or

4. for a public service entity (for example, volunteer fire department) when it cannot otherwise install sanitary facilities in a building.

5.

B. The following are not authorized:

1. Dosing siphons.
2. Cesspools of any kind or size;
3. OWTS receiving a projected flow over 10,000 gallons per day;
4. OWTS that utilize any form of effluent disposal that discharges on or above the post installation ground surface such as sprinklers, exposed drip lines, free-surface wetlands, or a pond;
5. OWTS on slopes greater than 30 percent without a slope stability report approved by a registered professional;
6. Decreased leaching area for IAPMO certified dispersal systems using a multiplier less than 0.70;
7. OWTS utilizing supplemental treatment without requirements for periodic monitoring or inspections;
8. OWTS dedicated to receiving significant amounts of wastes dumped from RV holding tanks;
9. Separation of the bottom of dispersal system to groundwater less than two feet;
10. Separation of the bottom of a seepage pit to groundwater less than 10 feet;
11. Installation of new or replacement OWTS where public sewer is available. Section 2.0 has additional details on this topic;
12. Public Water Wells. New or replacement OWTS with horizontal setbacks less than any of the following:
 - a. 150 feet from a public water well where the depth of the effluent dispersal system does not exceed 10 feet in depth;
 - b. 200 feet from a public water well where the depth of the effluent dispersal system exceeds 10 feet in depth;
 - c. Where the effluent dispersal system is within 600 feet of a public water well and exceeds 20 feet in depth, the horizontal setback required to achieve a two-year travel time for microbiological contaminants shall be evaluated. A qualified professional shall conduct this evaluation. However, in no case shall the setback be less than 200 feet.

**Table 4.6A
Minimum Horizontal Setbacks from Public Water Wells**

| Depth of Dispersal System | Horizontal Setback |
|-------------------------------|--|
| Less than or equal to 10 feet | 150 feet |
| Greater than 10 feet | 200 feet |
| Greater than 20 feet | 200 foot minimum 2 year travel time within 600 feet |

13. Public Water Systems. New or replacement OWTS with minimum horizontal setbacks less than any of the following:
- a. Where the effluent dispersal system is within 1,200 feet from a public water system's surface water intake point, within the catchment of the drainage, and located such that it may impact water quality at the intake point such as upstream of the intake point for flowing water bodies, the dispersal system shall be no less than 400 feet from the high water mark of the reservoir, lake or flowing water body.
 - b. Where the effluent dispersal system is located more than 1,200 feet but less than 2,500 feet from a public water system's surface water intake point, within the catchment area of the drainage, and located such that it may impact water quality at the intake point such as upstream of the intake point for flowing water bodies, the dispersal system shall be no less than 200 feet from the high water mark of the reservoir, lake or flowing water body.
14. OWTS receiving non-domestic wastewater in any amount. The State OWTS Policy does not grant authority to local jurisdictions to permit the treatment or disposal of non-domestic wastewater. See Section 22.2 for the process to permit non-domestic waste discharges.

**Table 4.6B
Minimum Horizontal Setbacks from Public Water Systems**

| Distance From Public Water Intake | Dispersal System Standard |
|--|---|
| Less than 1,200 feet | Greater than or equal to 400 feet water source ¹ |
| Equal to or greater than 1,200 feet and less than 2,500 feet | Greater than or equal to 200 feet water source ¹ |
| 1: water source is the high water mark of the reservoir, lake or flowing water body. | |

15. Construction and paving over dispersal systems and replacement areas.

4.7 Mitigations to Prohibitions

- A. To mitigate prohibition 4.6.B.5 (slopes over 30 percent) the following is required:
 1. A slope stability report, completed by a RCE or registered geotechnical engineer, shall be submitted to justify OWTS on slopes over 30 percent.
 2. The slope stability report shall be reviewed and approved by Permit Authority.
- B. To mitigate prohibition 4.6.B.7 (periodic monitoring), OWTS utilizing supplemental treatment

components shall be enrolled in the County’s Operational Permit Program, which requires monitoring and maintenance of the system.

- C. To mitigate prohibition 4.6.B.10 and 4.6.B.11 (vertical separation to groundwater) see section 22.
- D. To mitigate prohibition 4.6.B.13 and 4.6.B.14 (horizontal distances from water sources):
 1. Replacement OWTS shall utilize supplemental treatment and other mitigation measures to meet the treatment standards in Table 4.7, unless the Permit Authority finds that there is no indication that the previous system is adversely affecting the public water source, and there is limited potential that the replacement system could impact the water source based on topography, soil depth, soil texture, and groundwater separation.
 2. New OWTS shall meet the horizontal separation to the greatest extent practicable and shall utilize supplemental treatment to achieve the Table 4.7 standards and any other mitigation measures prescribed by the Permit Authority.

**Table 4.7
Treatment Standards for New OWTS Not in Conformance with
Horizontal Separation Requirements**

| Constituent | Standard |
|----------------------------------|---|
| Total Suspended Solids | 30 milligrams per liter as 30-day average |
| Fecal Coliform | 200 Most Probable Number (MPN) |
| Soil Depth | Greater than 3 feet |
| Depth to Groundwater | Greater than 3 feet |
| Soil Cover over Dispersal System | 12 inches |

4.8 Applications for Site Evaluations and Findings Reports

- A. Eligibility for filing or withdrawing applications for Site Evaluations and Findings Reports. Applications for Site Evaluations and Findings Reports shall only be filed or withdrawn by the owner or easement holder of the site, an authorized agent of the owner or easement holder, or other person with the written consent of the owner or easement holder.
- B. Requirements for applications for Site Evaluations and Findings Reports. Applications for Site Evaluations and Findings Reports shall be filed with the Permit Authority on the appropriate county application form. Each application for a Site Evaluation or Findings Report shall include all required fees and deposits, all plans and specifications, maps, reports, and other information and materials required by the Permit Authority for the specific type of application required by this OWTS Manual and by the Permit Authority’s policies.
- C. Site Evaluations and Findings Reports application fees, refunds, and withdrawals. The Board of Supervisors shall establish a schedule of fees for the processing of Site Evaluations and Findings Reports required by this OWTS Manual. The required application fees cover costs for staff time and the other activities involved in processing Site Evaluations and Findings Reports. Therefore, no refund due to disapproval or expiration is allowed. In the case of a withdrawal, the Permit Authority may refund up to ninety percent of the application fee prior to commencement of work related to Site Evaluations and Findings Reports.

- D. Time Limits of Site Evaluations and Findings Reports. The Permit Authority's decision regarding the limitation period of an application for a Site Evaluation or Findings Report shall be final.
1. Expiration of an application for a Site Evaluation or Findings Report. If a Site Evaluation is not completed or a Findings Report is not approved within one year following the date of filing a complete application, the Site Evaluation or Findings Report shall expire and be deemed withdrawn, without any further action by the Permit Authority.
 2. Extension of an application for a Site Evaluation or Findings Report. The Permit Authority may extend the expiration date of an OWTS Application up to 180 days when such extension is warranted, including but not limited to:
 - a. Correction of an error by the Permit Authority,
 - b. A legal action preventing the review or approval of the application from being completed within the one year time frame,
 - c. Protection of public health or safety, or
 - d. Other circumstances beyond the control of the applicant.
- E. Site Evaluation Applications Required.
1. Site evaluation applications are required for subdivisions and projects with more than four dwellings on one parcel.
 2. Applications for all other site evaluations are not required.
 3. The standards, procedures and protocols for site evaluations are applicable and in effect for all site evaluations regardless if an application is required or not required.

4.9 OWTS Applications

- A. Eligibility for filing or withdrawing an OWTS Application. An OWTS application shall only be filed or withdrawn by the owner or easement holder of the site, an authorized agent of the owner or easement holder, or other person with the written consent of the owner or easement holder.
- B. OWTS Application requirements. OWTS Applications shall be filed with the Permit Authority on the appropriate county application form. Each OWTS Application shall include all required fees and deposits, all plans and specifications, maps, reports, and other information and materials required by the Permit Authority for the specific type of application, pursuant to the Permit Authority's policies, and any other information and material the Permit Authority deems necessary to verify compliance with this OWTS Manual. Application submittal requirements are posted on the Permit Sonoma website.
- C. OWTS Application fees, refunds, and withdrawals. The Board of Supervisors shall establish a schedule of fees for the processing of OWTS Applications required by this OWTS Manual. The required application fees cover costs for staff time and the other activities involved in processing OWTS Applications. Therefore, no refund due to disapproval or expiration shall be allowed. In the case of a withdrawal, the Permit Authority may refund up to ninety percent of the application fee prior to commencement of the review of an OWTS Application.
- D. OWTS Construction Permit Applications for emergency repairs. OWTS Construction Permit Applications for emergency repairs shall comply with the provisions of Section 5.4.

- E. Time Limits of OWTS Applications. The Permit Authority's decision regarding the limitation period of an OWTS application shall be final.
1. Expiration of OWTS Application. If a permit is not issued or a vesting certificate application is not filed with the Permit Authority within one year following the date of filing a complete OWTS Construction Application, the OWTS Construction Application shall expire and be deemed withdrawn without any further action by the Permit Authority. If an approval is not granted within one year following the date of filing a complete OWTS Design Application, the OWTS Design Application shall expire and be deemed withdrawn without any further action by the Permit Authority.
 2. Extension of OWTS Application. The Permit Authority may extend the expiration date of an OWTS Application once for a period not exceeding 180 days, if the applicant files a written request with the Permit Authority before the expiration of the original one-year period and when such extension is warranted, including but not limited to:
 - a. Correction of an error by the Permit Authority,
 - b. A legal action preventing the review or approval of the application from being completed within the original one-year period,
 - c. Protection of public health or safety, or
 - d. Other circumstances beyond the control of the applicant.
 3. Renewal of OWTS Application. After the expiration of an OWTS Application, future consideration by the Permit Authority shall require submittal of a new OWTS Application and associated fees. Where a new OWTS Application is submitted within 180 days following the expiration of the original OWTS Application, the applicant may resubmit the original plans and specifications and the new OWTS Application shall be processed based on the OWTS regulations in effect at the time the expired OWTS Application was initially submitted. No expired OWTS Application shall be renewed in this fashion more than once.
- F. OWTS Application approval. Approval of an OWTS Application shall only constitute compliance with the provisions of this OWTS Manual and shall not mean or imply any other land use entitlement or construction approval.

4.10 OWTS Construction Permits Required

- A. OWTS construction permit requirements. Valid OWTS construction permits are required to install, repair, replace, modify, destroy, or abandon any part of a new or existing OWTS except where specified in Section 4.10.F Permit Exemptions. The Permit Authority may approve, conditionally approve or deny a permit to do any work on an OWTS. The Permit Authority may issue a permit only when all the requirements specified in this OWTS manual for an OWTS are met. The permit may contain conditions that apply to the construction, operation and maintenance of the system. Only OWTS work authorized in the approved plans may be performed unless approved in writing by the Permit Authority. The permit conditions shall be binding upon the property owner and successive property owners for the life of the system.
- B. Replacement OWTS Construction Permit. The following work requires a replacement OWTS construction permit:
1. The replacement or repair of a septic tank,

2. The replacement or repair of a sump tank,
 3. The replacement or repair of a pretreatment unit.
 4. The replacement of a dispersal system equal to or greater than 25-percent of the total linear footage of the existing dispersal system.
- C. Repair OWTS Construction Permit. The following work requires a repair permit:
1. The in-kind repair of a leach line or leach line segment, including pipe and trench materials, within an existing leach line trench. The trench shall be repaired no deeper than the existing trench and may include the removal of the biomat.
 2. The in-kind repair of a dispersal chamber or chamber segment, within an existing chamber trench. The trench shall be repaired no deeper than the existing trench and may include the removal of the biomat.
 3. The replacement or repair of up to 25 percent, on a cumulative basis, of the total linear footage of the existing dispersal system.
 4. The in-kind repair of an existing non-standard dispersal area within the same footprint as the original. Repairs shall be done in accordance with the original plans or original construction as observed in the field.
- D. Hardship Replacement Permit. Applicants may apply for a hardship replacement permit under the following circumstances:
1. Work would otherwise be considered a replacement permit.
 2. Financial constraints prevent compliance with replacement standards.
 3. A County Housing Rehabilitating Loan is not available.
 4. The landowner's household income is at or below one hundred twenty percent (120%) of the current Area Median Income (AMI) established by the U.S. Department of Housing and Urban Development.
 5. A hardship replacement permit application shall be submitted to the Permit Authority and shall comply with Section 4.9.
 6. Replacement septic tanks shall comply with the septic tank requirements of this OWTS Manual to the maximum extent feasible.
 7. Replacement dispersal systems shall comply with this OWTS Manual to the maximum extent feasible.
 8. Hardship replacement permits shall be forwarded to the appropriate RWQCB.
 9. Hardship replacement permits shall not be used to authorize building permits for the construction, re-construction, rebuilds, remodel, or work on a structure that would otherwise require an upgraded septic system.
- E. Permit Exemptions. The replacement or repair of the following components or segments are exempt from an OWTS permit.

1. Risers, lids, or covers,
 2. Sanitary tees,
 3. Effluent filters,
 4. Air release, balancing, diversion, and purge valves, valve boxes, or valve vaults,
 5. Distribution boxes,
 6. Performance wells,
 7. Clean outs,
 8. Sump tank pumps, piping, or floats set per original design specifications,
 9. Minor cracks in septic tanks or sumps tanks,
 10. Transmission line from structure to septic tank,
 11. Transmission line from tank to distribution box(es) or diversion valve(s),
 12. Solid transmission lines connecting distribution boxes and/or diversion valves,
 13. Hydrojetting.
- F. Compliance with OWTS construction permit. All work for which an OWTS permit is issued shall be done in compliance with the approved plans and specifications and the recommendations of required reports. The approved plans and specifications shall not be changed without the written approval of the Permit Authority.
- G. Revisions to OWTS Construction Permit. Proposed revisions to the approved plans and specifications shall be submitted to the Permit Authority in writing, together with all necessary technical information and design details. A proposed revision shall be approved only if the Permit Authority determines that the modification complies with the provisions of this OWTS Manual.
- H. Time Limits of OWTS Construction permit. The Permit Authority's decision regarding the limitation period of an OWTS permit shall be final:
1. Expiration of OWTS Construction Permit. Every permit issued by the Permit Authority under the provisions of this section shall expire by limitation within one year of permit issuance if no work has commenced as documented by the first approved inspection or upon commencement one year passes without an approved inspection. The Permit Authority may limit a permit to a lesser time period when necessary to abate dangerous or substandard conditions.
 2. Extension of OWTS Construction Permit. The Permit Authority may grant one or more extensions of a permit

when such extension is warranted,

 including but not limited to:
 - a. Correction of an error by the Permit Authority,
 - b. A legal action preventing the permitted work from being completed within the three-

- years,
- c. Protection of public health or safety, or,
 - d. Other circumstance(s) beyond the control of the permittee.
3. Renewal of OWTS Construction Permit. Before any work can commence or recommence on any expired permit or permit to legalize a violation, a new permit shall first be obtained. The new permit shall be obtained for all work necessary to finish the project including work already completed that has not been previously inspected and approved by the Permit Authority.
- a. Any new construction permits issued to recommence work started under an expired permit will be based on the OWTS regulations in effect at the time the original expired permit was issued.
 - b. Any new construction permits issued to commence work under an expired permit shall be based on the OWTS regulations in effect at the time of the original expired permit if the new permit application is submitted no more than six years from the date the original permit issuance.
 - c. Any new permits issued to commence work under an expired permit shall be based on the OWTS regulations in effect at the time of the new permit application if the new permit application is submitted more than six years from the date of the original permit issuance.
 - d. Any new construction permits issued to legalize a violation shall be governed by the OWTS regulations in effect at the time of the new permit application.
- I. OWTS Control Panels. New, replacement or repair of an OWTS control panel requires a building/electrical permit pursuant to the California Building Code and California Electrical Code. OWTS control panels do not require an OWTS permit for new installation, replacement or repair. Control panels shall comply with the required electrical features in OWTS Manual Section 8.5.D and in compliance with or superseding the original design parameters. The operations of the control panels will be evaluated with the overall performance of the OWTS system during the septic inspections.

4.11 OWTS Permit Implementation and Construction Inspections

- A. Responsibility of Work. The permittee shall be responsible for ensuring that the work approved under an OWTS permit is performed in compliance with the approved plans and specifications and the provisions of this OWTS Manual.
- B. Site Access. The permittee shall provide safe and adequate access to the site for inspection by the Permit Authority during the performance of all work approved under an OWTS permit.
- C. Notification of Change of Ownership. The permittee shall notify the Permit Authority of any change in property ownership prior to the completion of work. For non-standard OWTS permits, new owners shall provide updated documentation required to comply with Section 14.
- D. Notification of Change of Qualified Consultant. If a Qualified Consultant is changed during the course of the work, the work shall be stopped until the permittee or owner notifies the Permit Authority in writing of the change. The new Qualified Consultant must notify the Permit Authority in writing of their agreement to verify that the construction is in compliance with the

approved plans and specifications, issued permits, the provisions of this OWTS Manual and for compliance with section 4.12.B.2.

- E. Notification of noncompliance. The Qualified Consultant shall immediately report in writing to the Permit Authority and the permittee any instance of work not being done in compliance with this OWTS Manual, the approved plans and specifications, or any permit conditions, and shall also provide recommendations for corrective measures, if determined by the Qualified Consultant to be necessary.
- F. Field changes. After permit issuance, no change to the approved work shall occur without the prior written approval of the Permit Authority. If the Permit Authority determines that the changes to the OWTS are minor, the changes shall be shown on as-built plans. If the Permit Authority determines that the changes are significant, a request for a modification to the approved plans and specifications shall be filed as provided in Section 4.10.H.
- G. Protection of utilities. As required by Government Code Section 4216.2, the permittee shall contact the Underground Service Alert (USA) prior to starting any excavation that will be conducted in an area that is known, or reasonably should be known, to contain subsurface utility installations. Contact shall occur at least two working days, but not more than 14 calendar days, before the excavation starts. If practical, the excavator shall delineate with white paint or other suitable markings the area to be excavated.
- H. Stop work orders. The Permit Authority may order that any work performed contrary to the requirements of this OWTS Manual, the approved plans and specifications, or any permit conditions, or any work that has otherwise become hazardous to property or the public, be immediately stopped. It shall be unlawful and a violation of this chapter for any person to resume work that was ordered to be stopped by the Permit Authority. Work may resume if the Permit Authority required and the permittee has agreed to any necessary corrective measures. The Permit Authority shall authorize the resumption of the work in writing. A violation of a stop work order shall be punishable in compliance with county code.

4.12 OWTS Construction Inspections

- A. Inspections. The work and materials shall be inspected by the Permit Authority for compliance with the approved plans and specifications, issued permits, and the provisions of this OWTS Manual. The permittee shall comply with the Permit Authority's inspection request procedures. Construction Inspections shall be scheduled for regular Permit Authority work days. The Permit Authority must be notified at least one business day 24 hours in advance of desired inspection. No portion of the OWTS may be covered until it is inspected by the Permit Authority staff or the Permit Authority staff has authorized coverage prior to inspection. Approval as a result of an inspection shall not be construed to be an approval of a violation of the provisions of this OWTS Manual. Inspections presuming to give authority to violate or cancel the provisions of this OWTS Manual shall not be valid. The following construction inspections are required. The Permit Authority may waive attendance or approve alternate forms of inspections.
 1. Pre-construction consultation.
 2. Dispersal field inspection. Gravel placement, trenches or absorption bed should be level in previously approved proper location and placed on contour.
 3. Interim inspections, including squirt test and water tightness test of tank(s), if required.
 4. Final construction inspection of the completed system.

5. Final electrical inspection of associated building/electrical permit, if applicable.
 6. Startup inspection for pretreatment unit with Service Provider present.
 7. Final approval of the OWTS.
 8. Tank destruction, if applicable.
- B. Completion of work. No permittee shall be deemed to have complied with the provisions of this OWTS Manual until a final inspection of the work has been completed and approved by the Permit Authority. The permittee or their agent shall notify the Permit Authority when the work is ready for final inspection. Final approval shall not be given until all work has been completed in compliance with the approved plans and specifications and the following applicable items have been completed:
1. The Permit Authority staff has completed all required inspections.
 2. For OWTS required to be designed by a Qualified Consultant per section 4.4.A, the Qualified Consultant of record shall provide the Permit Authority with a signed and stamped letter certifying the OWTS was installed in compliance with the approved plans and specifications.
 3. For OWTS that require electricity to properly function, the final electrical inspection of the associated building/electrical permit must be approved.
 4. For any OWTS utilizing supplemental treatment, an Operational permit must be issued.

4.13 Change of Qualified Consultant

- A. Design Phase: Qualified Consultants may use any septic site evaluation information approved by the Permit Authority to prepare an OWTS Application or Findings Report even if the approved septic site evaluation work was not prepared or conducted by the same Qualified Consultant.
- B. Plan Review: If a Qualified Consultant is changed during the review of and prior to approval of an OWTS Application, the subsequent Qualified Consultant must either submit their own OWTS Application materials in compliance with section 4.7.F or provide written consent from the original Qualified Consultant to use their OWTS Application materials. When the latter situation is pursued, no changes may be made to the OWTS Application materials without the written consent of the original Qualified Consultant.
- C. Post Issuance/Construction: If a Qualified Consultant is changed after an OWTS Construction Permit is issued, then the Permittee and/or the subsequent Qualified Consultant must comply with section 4.11.E. The original Qualified Consultant should comply with section 4.12.B.2 to certify work completed under their oversight. If the original Qualified Consultant is unable or unwilling to comply with section 4.12.B.2 then the subsequent Qualified Consultant shall ensure any completed work complies with the approved plans and specifications. If revisions to the OWTS construction permit are required, then the subsequent Qualified Consultant must submit their own plans and specifications in compliance with section 4.10.H or obtain written consent from the original Qualified Consultant to alter or modify the originally approved plans or specifications. Revisions must be stamped and signed by the subsequent Qualified Consultant.

4.14 General Provisions

- A. Reserve Replacement Area is required for all OWTS per Section 4.3.
- B. Incompatible uses including, but not limited to, driveways, tennis courts, parking lots, swimmingpools, or structures over the replacement area shall be prohibited.
- C. No lot shall be improved in excess of its capability to properly absorb sewage effluent.
- D. No construction of OWTS shall occur during rain events, open wet weather groundwater determination season and/or saturated soil conditions, except when a Qualified Consultant notifies the Permit Authority in writing that unsaturated soil conditions exist and compaction and smearing will not occur. Inspections are subject to cancellation by the Permit Authority if conditions are deemed unsuitable.
- E. OWTS shall be installed in accordance with the plans and specifications approved by the Permit Authority. The permittee assumes all risks associated with construction of any OWTS components not approved by the Permit Authority including removal, replacement, or performing additional work to verify compliance with this OWTS Manual.
- F. OWTS shall be accessible for maintenance and repairs. Septic tanks and sump tanks shall be located to allow vacuum pumping.
- G. The building sewer and distribution piping shall be constructed with materials in conformance with the building sewer standards identified in the most current version of the California Plumbing Code. The sewer and distribution piping shall have approved watertight fittings with clean-outs provided in accordance with the most current version of the California Plumbing Code. The pipe section between the structure and the septic tank is approved and inspected via a building permit.
- H. All OWTS Construction Permit applications located near a water body that is subject to a TMDL and/or APMP may be subject to additional, more stringent, criteria than those systems located outside a designated APMP.
- I. Site evaluations are required for new or replacement OWTS per Section 4.8 and Section 7.
- J. Any application that cannot meet the standards may apply for a variance pursuant to Section 17.
- K. A structural or building addition may not encumber any designated reserve replacement area. A revised designated reserve replacement area may be established if needed.
- L. All land disturbing activities to access or prepare an OWTS construction site or an OWTS site evaluation area shall comply with the Stormwater Best Management Practices of the county's grading ordinance.
- M. Protection of human remains and archaeological resources. Where human remains or archaeological resources are discovered, all work shall be halted in the vicinity of the find, the Permit Authority shall be notified, and the following shall occur before work may be resumed:
 - 1. Human remains. If human remains or suspected human remains are discovered, the permittee shall notify the county coroner and comply with all state law requirements, including Health and Safety Code Section 7050.5 and Public Resources Code Section 5097.98, to ensure proper disposition of the

human remains or suspected human remains, including those identified to be Native American remains.

2. Archaeological resources. If archaeological resources or suspected archaeological resources are discovered, the Permit Authority shall notify the State Historic Preservation Officer and the Northwest Information Center at Sonoma State University. The permittee shall retain a qualified archeologist to evaluate the find to ensure proper disposition of the archaeological resources or suspected archaeological resources. All costs associated with the evaluation and mitigation of the find shall be the responsibility of the permittee. The Permit Authority shall provide notice of the find, to tribe(s) with cultural ties and affiliation with the geographic area if they requested notice of suspected archaeological resources, and provided a contact person and current address to which the notice is to be sent. The Permit Authority may consult with and solicit comments from notified tribes to aid in the evaluation, protection, and proper disposition of the archaeological resources or suspected archaeological resources. The need for confidentiality of information concerning the archaeological resources or suspected archaeological resources shall be recognized by all parties. For the purposes of this section, archaeological resources include historic or prehistoric ruins, burial grounds, pottery, arrowheads, midden, or culturally modified soil deposits. Artifacts associated with prehistoric ruins include humanly modified stone, shell, bone, or other cultural materials such as charcoal, ash, and burned rock indicative of food procurement or processing activities. Prehistoric domestic features include hearths, fire pits, or floor depressions; mortuary features are typically represented by human skeletal remains.
- N. For OWTS Applications within cities, the Permit Authority shall coordinate with the city and obtain the city's approval prior to the Permit Authority approving the OWTS Application.
 - O. OWTS shall be installed in accordance with the plans and specifications approved by the Permit Authority. The permittee assumes all risks associated with construction of any OWTS components not approved by the Permit Authority including removal, replacement, or performing additional work to verify compliance with this OWTS Manual.
 - P. OWTS that include an approved Supplemental Treatment Unit are required to be maintained and monitored under an Operating Permit. A qualified Service Provider shall conduct the maintenance and monitoring for the life of the system.
 - Q. Disposal lines shall be back-filled as soon after final construction inspection as possible. Disposal lines which have remained uncovered during any substantial rain may require abandonment or entire trenching.
 - R. All land disturbing activities to access or prepare an OWTS construction site or an OWTS site evaluation area shall comply with the Stormwater Best Management Practices of the county's grading ordinance.
 - S. Prior to septic system final approval, appropriate erosion control must be completed.
 - T. Applicants may appeal findings and/or decisions made by staff, the Supervisor and the Division Manager by submitting a request pursuant to department policy and procedures. The applicant must submit all documents and fees pursuant to the policy and procedures for management review. The decision made by the Permit

Authority Director or his/her designee is final.

4.15 Community Systems

- A. Community systems shall comply with this OWTS Manual.
- B. Community systems shall create a management agreement to ensure proper operation and maintenance, allocation of capacity, and administrative duties.
- C. Community systems with a maximum flow rate of more than 10,000 gallons per day shall be approved by the appropriate Regional Water Board.

4.16 Special Conditions and Exceptions

- A. Exceptions for Replacement Dispersal Area(s)
 - 1. For replacement dispersal area(s) having soils with less than 15 percent silt and clay and less than five feet separation to groundwater, the dispersal area(s) may be approved provided the following criteria are met:
 - a. Use of a non-standard system type.
 - b. Use of a pretreatment unit.
 - c. Use of ultraviolet disinfection.
 - d. Time dosing of the effluent.
 - 2. For replacement dispersal area(s) having soils with a percolation rate less than one minute per inch, the dispersal area(s) may be approved provided the following criteria are met:
 - a. Use of a non-standard system type.
 - b. Use of a pretreatment unit.
 - c. Use of ultraviolet disinfection.
 - d. Time dosing of the effluent.
 - 3. For replacement dispersal area(s) having soils with greater than 50 percent rock, stone, boulder, pebble, gravel, coarse fragments or similar material, the dispersal area(s) may be approved provided the following criteria are met:
 - a. The dispersal area(s) has a percolation rate of one to five minutes per inch; and
 - i. A non-standard system type with the use of a pretreatment unit; or
 - ii. A standard system type with the use of a pretreatment unit; and,
 - iii. A standard system type with the use of ultraviolet disinfection.
- B. Exceptions for Soil Depth
 - 1. For dispersal area(s) having soils depth less than three feet of required adequate soil

depth, the dispersal area(s) may be approved provided the following criteria are met:

- a. There is a minimum of two feet of adequate soil depth; and
 - i. Use of a non-standard system type; or
 - ii. Use of a standard system type with a pretreatment unit;
 - iii. If a reduction to a well, stream or sensitive receptor setback is also proposed in conjunction with a reduced soil depth, use of a standard system type with a pretreatment unit and ultraviolet disinfection.

C. Exception for Impermeable Soil Lens

1. For dispersal area(s) having an impermeable soil lens, the dispersal area(s) may be approved provided the following criteria are met:
 - a. There is permeable soil below the impermeable soil lens; and
 - b. The dispersal area is installed in the permeable soil; and
 - c. Use of a non-standard system type; and
 - d. Use of an approved pretreatment unit.

Section 5 OWTS Abatements, Abandonments and Repairs of Failing Systems

5.1 Abatements

- A. Any OWTS that causes sewage to surface or discharge at ground level, or any tank exfiltrating wastewater or infiltrating groundwater, is deemed to have an adverse effect on surface water, and is considered a failing system and a public health hazard. Such a system shall be immediately corrected or abated.
- A. There are two classes of septic work to which Code Enforcement penalty fees may apply: construction without permit or Permit Authority required repair of a failing septic system.

Once the Permit Authority determines a system is failing, adequate notification to the property owner is required.

1. A Notice of Violation or Notice and Order is adequate notification. However, A written notice or letter produced by the Permit Authority and provided to the property owner may be considered adequate notification as determined by the Permit Authority supervisory or management staff.
2. A reasonable period shall be given to allow the property owner to obtain a repair permit and complete the repair work. The Permit Authority shall treat failing septic systems in the same manner as sub-standard housing regarding the imposition of penalties.
 - a. If a repair permit is submitted within 30 days of sending a Notice of Violation or Notice and Order, only investigation fees apply.
 - b. If the owner delays response beyond 30 days, both investigation and penalties will apply.
 - c. The imposition of penalties may be extended if the applicant demonstrates a reasonable justification as to why a permit application could not be submitted within 30 days in accordance with Section 1-7.1(d) Sonoma County Code. Reasonable justifications include but are not limited to, groundwater studies or delays to accommodate the schedule of a licensed professional.
- C. For residential properties, the owner shall be allowed to hire a licensed septic tank pumper to pump the failing system until a repair system is installed. The allowed time period shall be determined by the Permit Authority.
- D. For commercial properties, the property owner or tenant may be allowed to pump the failing system at the discretion of the Permit Authority. Issues such as the availability of public restrooms, hand washing facilities, and use as a food facility must be taken into consideration for commercial properties.
- E. Investigation and penalty fees for the abatement of failing OWTS and/or installation of an OWTS without permit that may apply are as follows:
 1. For septic system replacement, repair or tank destruction permits where the property owner has voluntarily submitted a repair permit and no investigation has been conducted, the permit may be issued without investigation fee or penalty.
 2. For septic system replacement, repair, or tank destruction permits where a Notice of Violation

has been sent and the owner has submitted a septic repair permit within 30 days, penalties shall not be imposed.

3. For septic system replacement, repair or tank destruction permits where the Permit Authority has received a complaint, a Notice of Violation has been sent and the owner has not submitted for a permit within 30 days, penalties shall be calculated.
4. If the responsible party (owner or tenant) fails to correct the violation resulting in an administrative abatement hearing, any penalty as allowed under Section 1-7.1 of the Sonoma County Code may be imposed.
5. For standard or non-standard OWTS constructed without permit, penalties shall be calculated.

5.2 Abandonments

- A. Previously used septic tanks, sump tanks and other treatment tanks whose use has ceased shall be properly abandoned. Any abandonment or the destruction of portions or the entire OWTS shall be conducted under an OWTS permit issued by the Permit Authority such as a tank destruction or OWTS new or repair or replacement.
- B. Public Sewer Connection. If the septic tank is being destroyed because the parcel is being connected to public sewer, the applicant must submit documentation from the public sewer agency authorizing connection to the public sewer. The septic tank destruction inspection should be scheduled at the same time as the sewer connection inspection.
- C. The following requirements shall be observed when a septic tank or sump (e.g. tank) is abandoned.
 1. The tank shall be pumped of all the contents by a licensed septic tank pumper. The contents shall be properly disposed at a municipal treatment works and/or sanitation district.
 2. When abandoning the tank in place:
 - a. For concrete tanks, the top of the tank shall be removed and disposed at a sanitary landfill or the top of the tank may be broken into small pieces and placed into the tank.
 - b. The tank shall be filled with pea gravel, drain rock, sand, compacted native soils or concrete slurry.
 - c. The tank shall be destroyed to render the tank to be not usable as a septic tank and to prevent voids or unsafe ground surface.
 - d. The bottom of the tank may be perforated in each compartment to facilitate drainage.
 3. Off-site Disposal. As an option to in-situ abandonment, the entire tank may be removed and disposed of at an approved landfill. The Permit Authority shall conduct their inspection prior to backfilling. The hole shall be filled, compacted, and the area graded to drain.
- D. If the septic tank destruction was not inspected, certification by a licensed civil or geotechnical engineer that the tank has been properly removed and the tank hole adequately compacted with soil shall be provided to Permit Authority.

- E. A re-purposed septic tank, sump tank or treatment tank may be reused provided the tank is structurally sound, not deemed in failure per OWTS Manual Section 5.1, meets the standards in OWTS Manual Section 8.1, Septic Tank Requirements and a septic tank installation permit is obtained for installation and transportation to another property or for installation on the same property.

5.3 Failing System Numerical Standards

Any OWTS that causes sewage to surface or discharge at ground level, or any tank exfiltrating wastewater or infiltrating groundwater, is deemed to have an adverse effect on surface water, and is considered a failing system and a public health hazard. A failing system may be confirmed with analytical sampling which results exceeding the following numerical standards.

- A. Sample results greater than 240,000 of the most probable number (MPN) total coliform bacteria and/or a fecal coliform count greater than 2.2 MPN exceeds the maximum contaminant levels and is deemed to have an adverse effect on subsurface water.
 - 1. Such level of contamination as sampled from any purged performance well located 25 feet or greater down gradient from the dispersal field indicate a failing system.
 - 2. Failing systems shall be corrected or abated.
- B. Sample results exceeding 3,000 MPN but less than 240,000 MPN total coliform and/or less than 2.2 MPN fecal coliform, do not exceed the maximum contaminant levels (MCLs). However, these results define a OWTS as operating marginally.
 - 1. The contaminant levels are results of samples that have been taken from any purged performance well located 25 feet down gradient from the dispersal field.
 - 2. The OWTS Annual Monitoring Report that show ponding of effluent within 12 inches of trench bottom (but do not exceed MCLs mentioned above) are defined as operating marginally.

5.4 Repair of Failing Systems

- A. This section is reserved for when the landowner self-discloses the failure and seeks to repair the system on their own volition, as opposed to Section 5.1 (where the Permit Authority receives a complaint or takes notice of the failing system independent of the owner).
- B. Depending on the amount and type of proposed work, the repair of a failing system could be permit exempt, require a repair permit, or require a replacement permit. The type of required permit is detailed in Sections 4.10.
- C. Applications to repair a failing system shall be given priority over other types of permit applications received by the Permit Authority.
- D. In addition to the permit application requirements of Section 4.9, the application to repair a failing system shall include the following:
 - 1. A statement the system is in failure.
 - 2. The system component in failure.

3. The nature of the failure.
 4. The severity of the failure and/or the volume discharge of domestic waste to the surrounding environment.
 5. The location of any discharge of domestic waste.
- E. Upon receipt of such an application Permit Authority shall conduct a site visit within 48 business hours to verify the extent of the failure and extent of waste discharge.

Upon verification by Permit Authority of a failed or failing system, staff shall expedite the review and issuance of the repair permit.

Section 6 Requirements for Approval of Building Permits

Sonoma County Code Section 7-5(b)(2) requires a septic clearance in relation to building structure improvement projects. Building permits shall be reviewed for compliance with the OWTS requirements of this section. Building permits that do not impose additional burdens upon existing OWTS will be provided a septic clearance. Building permits that do impose additional burdens upon existing OWTS will be evaluated in accordance with this section.

Burdens upon existing systems include new wastewater flows, increases in wastewater flow or strength to existing systems and potential impacts to system components including, but not limited to, septic tanks, dispersal systems, and reserve replacement areas. Building permits shown to impose additional burdens upon existing systems and system components shall not be provided a septic clearance until the burden(s) have been mitigated.

6.1 Building Permits Not Reviewed by Well and Septic

- A. Projects that are exempt from obtaining a building permit pursuant to Sonoma County Code Section 7-13(C)(2) do not require a review by the Well and Septic Section.
- B. Building permits with no plan check pursuant to department building permit policies, do not require a review by the Well and Septic Section. The following are examples of building projects that do not require a plan review:
 - 1. Furnaces;
 - 2. Water Heaters;
 - 3. Re-Roofs;
 - 4. Siding;
 - 5. HVAC;
 - 6. Electric Services;
 - 7. Electrical Repairs;
 - 8. Interior Wall Coverings;
 - 9. Dry Rot Repair less than 40 linear feet; and
 - 10. Deck Repairs.
- C. Building permits with plan check for a structure that received damage from a declared disaster, earthquake, fire, flood, tree damage, or other untoward event do not require a review by the Well and Septic Section. Building permits must be applied for within five years of the catastrophic or damaging event.

6.2 Building Permit with Plan Check

- A. The Permit Authority shall review building permits requiring plan check. Any building permit not listed in Section 6.1 is required to have a plan review.
- B. The minimum septic compliance review shall ensure the property is served, at a minimum, by an

existing non- conforming septic system consisting of a septic tank and dispersal system and not by a cesspool.

6.3 New Structure on Undeveloped Land

- A. A New Structure on Undeveloped Land. A proposed structure with plumbing or wastewater flow(s) on undeveloped land that has no existing structure(s) and no existing septic system typifies this category.
 - 1. A new code compliant septic system is required.
 - 2. A code compliant reserve replacement area is required, pursuant to Sections 4.3.B and 6.6.C.

6.4 New Structure on Developed Land

- A. New Structure Unit as a Reconstructed Dwelling. The reconstruction of an existing structure with plumbing or wastewater flow(s) typifies this category.
 - 1. Either an existing code compliant septic system, pursuant to Section 6.7 is required; or
 - 2. A new code compliant septic system is required.
 - 3. A code compliant reserve replacement area is required for all dwelling units, pursuant to Sections 4.3.B and 6.6.C.
- B. Junior Accessory Dwelling Unit (JADU). An existing primary dwelling unit and the proposed construction of a new JADU typifies this category.
 - 1. Either an existing non-conforming septic system, pursuant to Section 6.8, is required; or
 - 2. An existing code compliant septic system, pursuant to Section 6.7, is required; or
 - 3. A new code compliant septic system is required.
- C. New Dwelling Unit as an Accessory Dwelling Unit (ADU) or Additional Primary Dwelling Unit (new unit). An existing primary dwelling unit and the proposed construction of a new ADU or proposed construction of an additional primary dwelling unit typifies this category. Construction of a new ADU or new additional primary dwelling unit could be a newly constructed structure or the conversion of an existing structure to a dwelling occupancy.

Applicant has the option to connect the ADU/new unit to the existing septic system serving the primary dwelling unit provided the existing septic system is code compliant and has capacity for the ADU/new unit wastewater flow or to construct a new code compliant septic system for the ADU/ new unit. This category may also include a bedroom swap between the existing primary dwelling and the proposed ADU/new unit.

- 1. Increase in Bedrooms
 - a. The primary dwelling shall have an existing code compliant septic system, pursuant to Section 6.7, which has sufficient capacity to treat and dispose the added wastewater flow associated with the ADU/new unit; or
 - b. The applicant shall provide a new code compliant septic system for the ADU/new unit.
 - c. A code compliant reserve replacement area is required for all dwelling units, pursuant to

Sections 4.3.B and 6.6.

- d. A code compliant reserve replacement area is required for the ADU/new unit, pursuant to Sections 4.3.B and 6.6.C.

2. Bedroom Swap

- a. The primary dwelling shall have an existing non-conforming septic system, pursuant to Section 6.8, provided no increase in the number of bedrooms or wastewater flow can be demonstrated.
- b. A reserve replacement area is required for all dwelling units, pursuant to Sections 4.3.B and 6.6.

- D. New guest house accessory to an existing dwelling. An existing primary dwelling unit and the proposed construction of a new guest house, with one or more additional bedrooms typifies this category. This category is not a dwelling unit.

Applicant has the option to connect the guest house to the existing septic system serving the primary dwelling unit provided the existing septic system is code compliant and has capacity for the guest house wastewater flow or to construct a new code compliant septic system for the guest house. This category may also include a bedroom swap between the existing primary dwelling and the proposed guest house.

1. Increase in Bedrooms:

- a. The primary dwelling shall have an existing code compliant septic system, pursuant to Section 6.7, which has sufficient capacity to treat and dispose the added wastewater flow associated with the guest house; or
- b. The applicant shall provide a new code compliant system for the new guest house.
- c. A code compliant reserve replacement area is required for all dwelling units pursuant to Sections 4.3.B and 6.6.
- d. A code compliant reserve replacement area is required for the guest house, pursuant to Sections 4.3.B and 6.6.

2. Bedroom Swap:

- a. The primary dwelling shall have a code compliant septic system or an existing non-conforming septic system, pursuant to Section 6.8, provided no increase in the number of bedrooms or wastewater flow can be demonstrated.
- b. A reserve replacement area shall be evaluated or required for dwelling units, pursuant to Sections 4.3.B and 6.6

- D. New non-bedroom accessory structure to an existing dwelling unit on developed land. An existing dwelling unit and the proposed construction of a new accessory structure with no bedrooms typifies this category. This category is not a dwelling unit. Examples of structures accessory to dwelling units include, but are not limited to, garages, barns, storage buildings, workshops, pool houses, art studios, exercise rooms and swimming pools.

- 1. A code compliant septic system or an existing non-conforming septic system, pursuant to Section 6.8, is required.

2. A reserve replacement area shall be evaluated or required for dwelling unit(s), pursuant to Sections 4.3 and 6.6.
 3. Non-bedroom accessory structures with plumbing shall provide documentation that the proposed structure does not represent an increase in wastewater flow to the existing septic system.
- E. New Structure Unit for a Commercial Use. The proposed structure and the OWTS design shall meet the conditions of the use permit and/or the zoning requirements for the parcel.
1. Either an existing code compliant septic system, pursuant to Section 6.7 is required; or
 2. A new code compliant septic system is required.
 3. A code compliant reserve replacement area is required for the proposed structure, pursuant to Sections 4.3.B and 6.6.

6.5 Building Improvements to an Existing Structure

A proposed addition, interior improvement, or tenant improvement to an existing structure typifies this category. This category has two sub-categories. The first category are those that may increase the occupancy loading (such as a bedroom addition) and/or increase the wastewater flow or strength. The second category include improvements that do not increase the occupancy loading and/or do not increase the wastewater flow or strength.

- A. Building Improvements that increase wastewater:
1. An existing code compliant septic system, pursuant to Section 6.7, and which has sufficient capacity to treat and dispose the increase in wastewater flow or strength is required; or,
 2. A new code compliant system for 100 percent of the wastewater flow is required.
 3. A code compliant reserve replacement area is required for the structure being improved, pursuant to Sections 4.3.B and 6.6.
- B. Building Improvements that do not increase wastewater:
1. An existing non-conforming septic system, pursuant to Section 6.8, is required.
 2. For proposed additions which increase the building footprint, a reserve replacement area shall be evaluated or required for the primary dwelling unit, pursuant to Sections 4.3.B and 6.6.

6.6 Reserve Replacement Area and Building Improvements

- A. A reserve replacement area shall be required if the proposed building improvement adds land encumbrance which then creates more than 50 percent land encumbrance or which then adds land encumbrance to a parcel with a pre-project land encumbrance over 50 percent.

A reserve replacement area shall be evaluated if the proposed building improvement adds land encumbrance which then creates 50 percent or less land encumbrance.

If the proposed building improvement does not add land encumbrance due to being placed within an existing encumbered area no further evaluation is required.

The process and criteria are detailed as follows:

1. The existing percent land encumbrance shall be determined. The percent land encumbrance is determined by dividing the encumbered land area by the total land area of the subject parcel to determine a percent land encumbrance.
 2. Encumbered areas shall only be counted once. Building improvement(s) within an existing encumbrance shall not increase the land encumbrance. For example, an existing or proposed structure within a well setback shall not be added to the encumbered land area.
 3. The overall percent land encumbrance and the itemized encumbrances used in the calculation shall be submitted with the building permit application. Itemization of the land encumbrances is optional if the percent encumbrance is over the 50 percent criteria.
 4. When the proposed building improvement creates 50 percent or less land encumbrance, the proposed building improvement shall be evaluated to ensure the proposed building improvement does not adversely affect the reserve replacement area pursuant to Section 6.6.B.
 5. When the proposed building improvement creates greater than 50 percent land encumbrance, the reserve replacement area shall be required pursuant to Section 6.6.C. Proposed building improvements within an existing encumbrance do not create additional land encumbrances.
- B. Evaluation of a reserve replacement areas consists of:
1. If a reserve replacement area has been identified and is on file with the Permit Authority, a site map documenting the location of the existing replacement area and the proposed structure or structural improvements shall be submitted; or,
 2. A site map documenting the location of a potential reserve replacement area and the proposed structure or structural improvements shall be provided.
- C. A reserve replacement area shall be demonstrated pursuant to this OWTS Manual with either existing records on file with the Permit Authority or with a current Septic Design Application. The existing records for the Septic Design Application shall consist of site evaluations for soil type, percolation rate and depth of groundwater, pursuant to pertinent sections of this OWTS Manual. Additionally, a preliminary design of the replacement septic system including system type, sizing calculations, system layout within the proposed reserve replacement area, site constraints and setbacks.

6.7 Existing Code Compliant Septic System Documentation

- A. Documentation of an existing code compliant septic system consists of one of the following:
1. A finalized septic system permit with documentation the system meets current standards.
 2. A finalized mound system permit that was approved under prior regulations shall be considered “code compliant” for the purposes of this section. The previous sizing standards resulted in mound systems approximately 95 percent of the current sizing calculations. The disruption to the existing mound OTWS and cost to the owner does not justify the five percent expansion.
 3. A findings report is required when:

- a. Documentation for a finalized septic system is incomplete or shows non-compliance with current standards including conditions of an Operational Permit; or
- b. A septic permit does not exist.

6.8 Existing Non-Conforming Septic System Documentation

- A. Documentation of an existing non-conforming septic system consists of one of the following:
1. A county record clearly showing the septic tank and dispersal system; or,
 2. County Assessor record clearly showing the septic tank and dispersal system; or,
 3. A finalized septic system permit showing the septic tank and dispersal system; or,
 4. A findings report is required when:
 - a. Information and/or documentation is missing from a septic permit file; or
 - b. A septic permit does not exist.
 5. Reserve replacement areas shall be included in a findings report if they are existing or known.

6.9 Findings Report

- A. Finding Reports shall include, but not be limited to, the following information:
1. The Finding Reports shall be signed and stamped by a Qualified Consultant.
 2. A description of the on-site system including the individual components and how the details of the system were determined.
 3. A site map including the parcel, assessor's parcel number, existing structures, proposed structures, the located septic tank, the dispersal system, the replacement area when required, a north arrow, direction of slope, and scale or measurements to relevant features on the property.
 4. The dispersal system shall be located if the structural improvement and/or associated construction activity has the potential to damage or adversely affect the primary and/or replacement dispersal system. Reserve replacement areas shall be included in a findings report if they are existing or known.
 5. Indicate the bedrooms/units/structures served by the system. Documentation of structures may be derived from building permits and/or assessor records.
 6. Evaluation of system performance including at least one of the following:
 - a. Uncovering distribution boxes to ensure that the system is functioning adequately;
 - b. Hydraulic load test (see Section 6.10.A-C);
 - c. Pump test (see Section 6.10.D); or
 - d. Evaluation of profile holes.

7. Estimated age of system.
 8. Estimated sizing of the OWTS: linear feet and area of dispersal system; capacity in gallons per day; number of bedrooms.
 9. Inspection of all tanks. Inspection shall include presence or absence of baffle walls, inlet and outlet tees, and effluent levels on the inlet and outlet sides of the tank, root intrusion and cracks in the tank.
 10. For OWTS subject to an Operational Permit, resolution of any outstanding non-compliant issues including but not limited to payment of past due fees, submission of monitoring forms, adequately addressing correction notices, and allowing Permit Sonoma staff to perform required inspections under the Operational Permit program.
 11. Classification and justification of system as either a code compliant system or as an existing non-conforming system. Any available historical information such as past permits or site evaluations shall be disclosed and included.
 12. For code compliant septic systems, the following shall be included pursuant to pertinent sections of this OWTS Manual: the soil type, percolation rate, depth of groundwater, elevation of dispersal system, and design calculations.
- B. Finding Reports shall be classified by the following types and shall include the numerated items which refer to Section 6.9.A and B:
1. Findings Report – Type 1. A Findings Report – Type 1 shall include items 6.9.A.1 through 4.
 2. Findings Report – Type 2. A Findings Report – Type 2 shall include items 6.9.A.1 through 11.
 3. Findings Report – Type 3. A Findings Report – Type 3 shall include items 6.9.A.1 through 12.
- C. The type of Findings Report by building project type are as follows:
1. New Dwelling Units on Developed Land
 - a. Reconstruction – Type 3 Findings Report
 - b. New JADUs – Type 2 Findings Report
 - c. New ADUs – Type 3 Findings Report
 - d. New Guest House with Increase in Bedrooms – Type 3 Findings Report
 2. New Accessory Structures (non-bedroom)
 - a. With plumbing – Type 2 Findings Report
 - b. Without Plumbing – Type 1 Findings Report
 - c. New Guest House with Bedroom Swap – Type 2 Findings Report
 3. Building Improvements with
 - a. Increase in Flow or Strength – Type 3 Findings Report

b. No increase in flow or strength – Type 1 Findings Report

D. Findings Reports shall not be used to permit or legalize unpermitted work.

6.10 Hydraulic Load Test Guidelines

A. Septic Tank Hydraulic Load Test

The septic tank hydraulic load test as described here, is conducted only for standard gravity-fed leachfields and does not apply if the system utilizes a pump. A separate pump test procedure is described below. The hydraulic load test is conducted after completion of a review of background data, an initial field performance, and the septic tank inspection. The hydraulic load test is conducted by surcharging the septic tank with approximately 150 gallons of water over a 20-to-30-minute period; and then observing the rise in water in the tank and the subsequent draining process. Tracer dye may be used to assist in observing leachfield failure.

A garden hose discharging into the outlet side of the tank can be used to surcharge the tank. The hose outlet should remain well above the water level of the tank to prevent cross-contamination. Before starting the test, the flow rate from the hose should be determined (for example, with a 5-gallon bucket and stopwatch) to properly gauge the amount of surcharge water added to the tank. Alternately, a portable water meter can be installed between the house faucet and the hose to directly measure the water volume added.

B. Test Procedures

The step-by-step procedures for the hydraulic load test are ~~then~~ as follows:

1. Measure the location of the static water line in the septic tank (at the outlet side) as an initial reference point.
2. Begin surcharging the tank with water to start the hydraulic load test.
3. Observe any rise in the liquid level at the outlet pipe and measure the water level at the end of filling. Typically, the liquid level will rise from one half to one inch, at which point the liquid level should stabilize for the remainder of filling; and the return to the initial level in a matter of minutes after filling is stopped.
4. After the filling cycle is finished, the water level decline in the septic tank is observed until the initial level is reached; and the time to achieve this is recorded. If the initial level is not attained within 30 minutes, the test shall be terminated and the final water level is noted.

C. System Rating

Based upon the water level readings during the test, a hydraulic performance rating shall be assigned to the system in accordance with the guidelines provided ~~in F.~~ below. It should be emphasized that these are guidelines only, and special circumstances may be cause for modifying the evaluation and rating of particular systems. A system receiving a “Failed” rating shall require appropriate upgrading.

The following guidelines shall be followed for Hydraulic Load Test ratings of septic tanks:

1. No noticeable rise in water level during filling-**Excellent**;
2. Maximum water level rise of about one inch, with rapid decline to initial level within about five minutes after end of filling-**Good**;

3. Maximum water level rise of about two inches, with decline to initial level within about 15 minutes after end of filling-**Satisfactory**;
4. Maximum water level rise of about three inches, with decline to initial level within about 30 minutes after end of filling-**Marginal**;
5. Water level rise of more than three inches, with decline not reaching initial level within 30 minutes after end of filling-**Poor**;
6. Water level rise of more than three inches, with no noticeable decline within 30 minutes after end of filling-**Failed**.

D. Pump Systems

The pump test is conducted by adding sufficient water to the basin to activate the pump “on” control and observing the performance of the system over at least one pumping cycle. The total amount of water added should be about 150 gallons, to approximate the same hydraulic loading of the leachfield as for gravity systems. Using a garden hose, the water may be added to the outlet side of the septic tank, or directly to the pump basin. If filling the basin directly, care should be taken to minimize turbulence and disturbance of sediment or sludge that may have collected in the basin. This can be best accomplished by directing the stream of water against the interior side of the chamber rather than directly toward the bottom of the pump chamber.

Observe the filling of the basin and note and measure the point at which the pump is activated. Immediately stop the filling operation and observe the pumping cycle until the pump shuts off. While the pump is discharging, examine the piping system for any leaks. Note and measure the depth at which the pump shuts off and calculate the volume of water between the “on” and “off” measurements. Compare this dose with the design dose volume specified for the system. If the dose is too high or too low, float controls should be adjusted by a licensed and properly qualified contractor.

The pumping cycle (from “on” to “off”) levels should be timed and the results recorded on the inspection form. Typically, if the pump is sized and operating properly, pump operation lasts one to five minutes per dose. Pump cycles lasting longer than this may indicate leachfield clogging and/or pump deficiencies. If this is observed, it should be noted and further investigation of the pump and leachfield should be conducted to determine the specific cause.

If during filling of the basin, the pump does not activate when water reaches the high liquid level control (for example “on” float), discontinue the pump test. This indicates a pump failure, defective float switch, or wiring problems and will require the repair service of a contractor familiar with these types of systems. The pump system failure should be noted, communicated immediately to the resident/owner and followed up with a notice requiring prompt corrective action.

E. Final Leachfield Inspection

At the completion of the hydraulic load test, the drain field area and downslope areas should be checked again for indications of surfacing effluent, wetness, or odor. If any of these conditions exist as a result of the hydraulic load test, this shall be considered conclusive evidence of system failure. If the field observations of wetness are not obviously the result of the hydraulic load test, further investigation may be necessary to determine if the drain field is failing and the cause of the failure. Additional investigative work may include water quality sampling (for total and fecal coliform, ammonia and nitrate) or dye testing. The cause of seepage could be related to gopher holes, site drainage or erosion problems, excessive water use or simply the age of the dispersal system.

F. Clean Up

At the completion of the OWTS inspection and testing, all access lids shall be replaced and tools cleaned before leaving the site. All tools and equipment that come in contact with wastewater should be cleaned and disinfected with a one to five water to bleach solution: and all contaminated rinse water shall be disposed of in the septic tank.

Section 7 Site Evaluation Methods and Investigation Requirements

7.1 Site Evaluations

- A. Site evaluations are required for new or replacement OWTS.
- B. Site evaluations shall be conducted by Qualified Consultants experienced in OWTS. Qualified Consultants shall coordinate site evaluations with the Permit Authority staff.
- C. Site evaluations shall be conducted in accordance with regulations and Permit Authority policies.
- D. Non-suitable site evaluation locations shall be avoided in the OWTS design. Where overlapping locations (radii) occur with a non-suitable location and a suitable location, split the distance equally between the two locations. In instances of overlapping test areas, additional locations may be required to demonstrate a suitable Site Evaluation Area.

For example, when the intended design is a 12 inches subsurface drip system and two holes yield 36 inches to groundwater and one hole yields 28 inches, then an additional hole with a groundwater depth of at least 36 inches will be needed between the dissimilar holes.

- E. The Qualified Consultant shall complete form WLS-091, WLS-092 or WLS-093, to document the site evaluation(s). WLS forms shall be filled out completely and submitted with the OWTS Design Report and OWTS application.
- F. The Qualified Consultant shall document and submit data for all site evaluations conducted in the Site Evaluation Area for the OWTS that is the subject of the OWTS Design Report and OWTS Application.
- G. Abbreviations used in classifying soils shall follow the USDA Field Manual nomenclature.
- H. Site evaluation locations shall be well marked with a lath and ribbons to increase visibility. All locations must be clearly marked, labelled, numbered or lettered and match the most current site plan.
- I. Photographic or imagery documentation shall be required for soil evaluations.
 - 1. Photographs/images shall be in color;
 - 2. Photographs/images shall be a minimum resolution of 10 mega-pixel;
 - 3. Photographs/images shall be taken of the side wall;
 - 4. A measuring tape shall be included in each image for scale;
 - 5. Photographs/images shall be included with the completed WLS form.

7.2 General Site Criteria

- A. General site criteria include, but are not limited to, the following:
 - 1. Land area available for primary dispersal area;
 - 2. Land area available for replacement area;
 - 3. Ground Slope;
 - 4. Soil Depth;

5. Depth to Groundwater;
6. Soil Percolation Rates (Tables 7.2a, 7.2b and 7.10);
7. Setback Distances (Table 7.2c);
8. Location of cut banks, fills, or evidence of past grading activities, natural bluffs, sharp changes inslope, soil landscape formations, rock outcrops, trees, and unstable land forms within 50 feet of the dispersal and replacement areas;
9. Location of wells, intercept drains, streams, springs, and other bodies of water on the property in question and within 100 feet on adjacent properties;
10. Other information may be necessary to evaluate the suitability of the proposed OWTS.

B. Altered Terrain

1. OWTS shall not be placed in areas that have been filled, excavated, ripped, plowed, modified, or altered in such a way as to increase or create areas of localized flooding, drainage problems, or geologic instability.
2. Such areas that have been excavated, ripped, plowed, altered, and/or modified may be acceptable if the soil is stable and soil evaluation indicates characteristics acceptable for installation of an OWTS such as approved structure, texture, consistency, pore space, percolation rate, soil depth, and separation to groundwater pursuant to this OWTS Manual.

C. Potential Land Instability

1. If the Permit Authority determines the OWTS may cause a land instability concern, a soils report prepared at the applicant's expense, by a California licensed engineering geologist, geotechnical engineer or registered geologist shall be required.

D. Setback Requirements

1. All new and replacement OWTS shall conform to the setback distances detailed in Table 7-2c below.

E. Reduced Setbacks for effluent dispersal areas from Streams/Waterways/Water Bodies.

1. Replacement OWTS with no increase in flow and an approved pretreatment, the location of the effluent dispersal shall conform to the distances contained in the Stream/Waterways/Water Bodies subsection of Table 7-2c multiplied by 0.5.
2. Replacement OWTS with an increase in flow and with an approved pretreatment and with a disinfection unit, the location of the effluent dispersal shall conform to the distances contained in the Stream/Waterways/Water Bodies subsection of Table 7-2c multiplied by 0.5.
3. New OWTS with an approved pretreatment unit shall conform to the distances contained in the Stream/Waterways/Water Bodies subsection, excluding Mapped Blue Line / Blue dot and dashed streams, of Table 7-2c multiplied by 0.8.
4. The reduced setback shall be the greatest extent possible but shall not be reduced to less than those detailed in 7.2.E.1, 7.2.E.2 or 7.2.E.3 above.

F. Reduced Setback for septic tanks or sumps from Streams/Waterways/Water Bodies.

1. Septic tanks or sumps for new or replacement OWTS shall conform to the distances contained in the Stream/Waterways/Water Bodies subsection of Table 7-2c multiplied by 0.5 provided the following conditions are met:
 - a. Waterproof surface barrier applied to concrete tank consistent with Manual of Concrete Practice ACI 515.1R
 - b. Flexible rubber boots or compression seals meeting ASTM C 117 used for inlet and outlet connections to provide flexibility in case of tank settlement while still maintaining watertight seal
 - c. An approved double wall fiberglass tank may be used in lieu of a concrete tank
 - d. Tank leakage/watertightness test

G. Reduced Setback for replacement effluent dispersal areas from Wells.

1. The location of the replacement effluent dispersal areas shall conform to the distances contained in the Private Water Supplies subsection of Table 7-2c multiplied by 0.5 provided:
 - a. The well is existing and on the same parcel as the replacement dispersal area.
 - b. The replacement dispersal area is no closer to the well than the existing dispersal area
 - c. The replacement dispersal system is part of a non-standard system or has an approved pretreatment unit.

H. Reduced Setback from Property Lines.

1. The downslope setback of a non-standard dispersal area may be reduced to 10 feet provided:
 - a. The slope is no greater than 12 ½ percent;
 - b. The consultant and property owner state in writing that the location of the approved OWTS is on the subject property and the approved OWTS plan shows that the location of the dispersal area is on the subject property; and,
 - c. The downslope performance well, if required, is placed at the property line.

I. Reduced Setback from Structures.

1. The location of OWTS components shall conform to the distances contained in the Building or Structures subsection of Table 7-2c multiplied by 0.5 provided:
 - a. The reduced setback to a non-occupiable structure (concrete slab, pathway, patio, deck, etc) will not interfere with the performance of the OWTS.
 - b. The reduced setback to an occupiable structure or pool will not impact the integrity of the structure's foundation or performance, create soil saturation around the foundation or pool. An engineer's certification may be required.
 - c. The reduced setback will not impede access to the septic tank and/or dispersal field.

Table 7.2a
Sewage Application/Soil Loading Rates
(Gallons per Square Foot per Day)

| Column 1 | Column 2 |
|---|--|
| 1-3 MPI = 1.200 gallons/square foot/day | 47 MPI = 0.437 gallons/square foot/day |
| 4 MPI = 1.143 gallons/square foot/day | 48 MPI = 0.430 gallons/square foot/day |
| 5 MPI = 1.086 gallons/square foot/day | 49 MPI = 0.423 gallons/square foot/day |
| 6 MPI = 1.029 gallons/square foot/day | 50 MPI = 0.417 gallons/square foot/day |
| 7 MPI = 0.971 gallons/square foot/day | 51 MPI = 0.410 gallons/square foot/day |
| 8 MPI = 0.914 gallons/square foot/day | 52 MPI = 0.403 gallons/square foot/day |
| 9 MPI = 0.857 gallons/square foot/day | 53 MPI = 0.397 gallons/square foot/day |
| 10 MPI = 0.800 gallons/square foot/day | 54 MPI = 0.390 gallons/square foot/day |
| 11 MPI = 0.786 gallons/square foot/day | 55 MPI = 0.383 gallons/square foot/day |
| 12 MPI = 0.771 gallons/square foot/day | 56 MPI = 0.377 gallons/square foot/day |
| 13 MPI = 0.757 gallons/square foot/day | 57 MPI = 0.370 gallons/square foot/day |
| 14 MPI = 0.743 gallons/square foot/day | 58 MPI = 0.363 gallons/square foot/day |
| 15 MPI = 0.729 gallons/square foot/day | 59 MPI = 0.357 gallons/square foot/day |
| 16 MPI = 0.714 gallons/square foot/day | 60 MPI = 0.350 gallons/square foot/day |
| 17 MPI = 0.700 gallons/square foot/day | 61 MPI = 0.345 gallons/square foot/day |
| 18 MPI = 0.686 gallons/square foot/day | 62 MPI = 0.340 gallons/square foot/day |
| 19 MPI = 0.671 gallons/square foot/day | 63 MPI = 0.335 gallons/square foot/day |
| 20 MPI = 0.657 gallons/square foot/day | 64 MPI = 0.330 gallons/square foot/day |
| 21 MPI = 0.643 gallons/square foot/day | 65 MPI = 0.325 gallons/square foot/day |
| 22 MPI = 0.629 gallons/square foot/day | 66 MPI = 0.320 gallons/square foot/day |
| 23 MPI = 0.614 gallons/square foot/day | 67 MPI = 0.315 gallons/square foot/day |
| 24 MPI = 0.600 gallons/square foot/day | 68 MPI = 0.310 gallons/square foot/day |
| 25 MPI = 0.593 gallons/square foot/day | 69 MPI = 0.305 gallons/square foot/day |
| 26 MPI = 0.587 gallons/square foot/day | 70 MPI = 0.300 gallons/square foot/day |
| 27 MPI = 0.580 gallons/square foot/day | 71 MPI = 0.295 gallons/square foot/day |
| 28 MPI = 0.573 gallons/square foot/day | 72 MPI = 0.290 gallons/square foot/day |
| 29 MPI = 0.567 gallons/square foot/day | 73 MPI = 0.285 gallons/square foot/day |
| 30 MPI = 0.560 gallons/square foot/day | 74 MPI = 0.280 gallons/square foot/day |
| 31 MPI = 0.553 gallons/square foot/day | 75 MPI = 0.275 gallons/square foot/day |
| 32 MPI = 0.545 gallons/square foot/day | 76 MPI = 0.270 gallons/square foot/day |
| 33 MPI = 0.538 gallons/square foot/day | 77 MPI = 0.265 gallons/square foot/day |
| 34 MPI = 0.531 gallons/square foot/day | 78 MPI = 0.260 gallons/square foot/day |
| 35 MPI = 0.523 gallons/square foot/day | 79 MPI = 0.255 gallons/square foot/day |
| 36 MPI = 0.516 gallons/square foot/day | 80 MPI = 0.250 gallons/square foot/day |
| 37 MPI = 0.509 gallons/square foot/day | 81 MPI = 0.245 gallons/square foot/day |
| 38 MPI = 0.501 gallons/square foot/day | 82 MPI = 0.240 gallons/square foot/day |
| 39 MPI = 0.494 gallons/square foot/day | 83 MPI = 0.235 gallons/square foot/day |
| 40 MPI = 0.487 gallons/square foot/day | 84 MPI = 0.230 gallons/square foot/day |
| 41 MPI = 0.479 gallons/square foot/day | 85 MPI = 0.225 gallons/square foot/day |
| 42 MPI = 0.472 gallons/square foot/day | 86 MPI = 0.220 gallons/square foot/day |
| 43 MPI = 0.465 gallons/square foot/day | 87 MPI = 0.215 gallons/square foot/day |
| 44 MPI = 0.457 gallons/square foot/day | 88 MPI = 0.210 gallons/square foot/day |
| 45 MPI = 0.450 gallons/square foot/day | 89 MPI = 0.205 gallons/square foot/day |
| 46 MPI = 0.443 gallons/square foot/day | 90-120 MPI = 0.200 gallons/square foot/day |

**Table 7.2b
Illustrative Table for Sizing Absorption Area**

| Texture | Structure Shape | Structure Grade | Hydraulic Loading (gallons/square foot/day) STE¹ | Hydraulic Loading (gallons/square foot/day)STE² |
|---|-----------------------------|-------------------------------------|--|---|
| Coarse sand, sand, loamy coarse sand | Single grain | Structureless | 1.2 | 1.6 |
| Fine sand, loamy fine sand | Single grain | Structureless | 0.6 | 1.0 |
| Sandy loam, loamy sand | Massive Platy | Structureless | 0.35 | 0.5 |
| Sandy loam, loamy sand | Massive Platy | Weak | 0.35 | 0.5 |
| Sandy loam, loamy sand | Prismatic, blocky, granular | Weak | 0.5 | 0.75 |
| Sandy loam, loamy sand | Prismatic, blocky, granular | Moderate, strong | 0.8. | 1.0 |
| Loam, silt loam, sandy clay loam, fine sandy loam | Massive platy | Structureless Weak | - | - |
| Loam, silt loam, sandy clay loam, fine sandy loam | Prismatic, blocky, granular | Weak, moderate | 0.5 | 0.75 |
| Loam, silt loam, sandy clay loam, fine sandy loam | Prismatic, blocky, granular | Strong | 0.8 | 1.0 |
| Sandy clay, silty clay loam, clay loam | Massive Platy | Structureless weak, moderate strong | - | - |
| Sandy clay, silty clay loam, clay loam | Prismatic, blocky, granular | Weak, moderate | 0.35 | 0.5 |
| Sandy clay, silty clay loam, clay loam | Prismatic, blocky | Strong | 0.6 | 0.75 |
| Clay, silty clay | Massive Platy | Structureless weak, moderate strong | - | - |
| Clay, silty clay | Prismatic, blocky, granular | Weak | - | - |
| Clay, silty clay | Prismatic, blocky, granular | Moderate, strong | 0.2 | 0.25 |

1: STE=septic tank effluent; PTE=pre-treated effluent.

2: Higher hydraulic loading rates for pretreated effluent may only be used when pretreatment is not used for one foot of vertical separation credit.

**Table 7.2c
Setback Requirements**

| | Minimum horizontal distance required from: | Septic Tank (All Systems) (feet) ¹ | Dispersal Area (Standard) (feet) ^{1,2} | Dispersal Area (Non Standard) (feet) ^{1,2} |
|----|---|---|---|---|
| | Building or Structures (including swimming pools, driveways, parking areas and paved areas): | | | |
| 1 | Up gradient | 5 | 8 | 10 |
| 2 | Laterally | 5 | 8 | 10 |
| 3 | Down gradient | 5 | 8 | 25 |
| 4 | Swimming pools & related drainage (down gradient) | 5 | 8 | 25 |
| | Property line and/or easements: | | | |
| 5 | Up gradient | 5 | 5 | 10 |
| 6 | Laterally | 5 | 5 | 10 |
| 7 | Down gradient | 5 | 5 | 25 |
| | Private Water Supplies: | | | |
| 8 | Water supply wells and springs | 50 | 100 | 100 |
| 9 | Domestic water pipe ^{3,4} | 5 | 5 | 5 |
| | Destroyed water well | 15 | 15 | 15 |
| | Public Water Mains: | | | |
| 10 | Pressure Public Water Main ^{3, 4} | 5 | 10 | 10 |
| | Public Water Supply Wells: | | | |
| 11 | OWTS dispersal depth 10 feet or less | 50 | 150 | 150 |
| 12 | OWTS dispersal depth greater than 10 feet | 50 | 200 | 200 |
| | Public Water Supply Surface Intake: | | | |
| 13 | Less than 1200 feet to OWTS | 50 | 400 | 400 |
| 14 | Less than 2500 feet to OWTS | 50 | 200 | 200 |
| | Streams/Waterways/Water Bodies: ⁵ | | | |
| 15 | Perennial Stream | 50 | 100 | 100 |
| 16 | Ephemeral Streams | 25 | 50 | 50 |
| 17 | Natural Swale (no bed and bank) | 15 | 15 | 25 |
| 18 | Drainage ways greater than 18 inches in depth | 25 | 50 | 50 |
| 19 | Drainage ways 18 inches or less in depth | 15 | 15 | 25 |
| 20 | Ocean, lakes, ponds or reservoir ⁶ | 50 | 100 | 100 |
| 21 | Lined ponds or reservoir ⁶ | 25 | 50 | 50 |
| 22 | Wetlands, edge of delineated property ⁷ | 25 | 50 | 50 |
| | Storm Water Infrastructure | | | |
| 23 | Storm Drain Inlets – Up gradient | 15 | 15 | 15 |
| 24 | Storm Drain Inlets – Lateral | 15 | 15 | 15 |

| | Minimum horizontal distance required from: | Septic Tank (All Systems) (feet) ¹ | Dispersal Area (Standard) (feet) ^{1,2} | Dispersal Area (Non Standard) (feet) ^{1,2} |
|----|---|---|---|---|
| 25 | Storm Drain Inlets– Down gradient | 15 | 25 | 25 |
| 26 | Storm Drain Pipes greater than 18 inches in diameter | 25 | 50 | 50 |
| 27 | Storm Drain Pipes 18 inches or less in diameter | 15 | 15 | 25 |
| 28 | Watertight Storm Drain Pipes greater than 18 inches in diameter | 10 | 25 | 25 |
| 29 | Watertight Storm Drain Pipes 18 inches or less in diameter | 5 | 5 | 10 |
| 30 | Post Construction Storm Water Treatment Facility – Up gradient | 15 | 15 | 15 |
| 31 | Post Construction Storm Water Treatment Facility – Lateral | 15 | 15 | 15 |
| 32 | Post Construction Storm Water Treatment Facility – Down gradient; greater than 12 inches in depth | 25 | 50 | 50 |
| 33 | Post Construction Storm Water Treatment Facility – Down gradient; 12 inches in depth or less | 15 | 25 | 25 |
| | Groundwater Infrastructure | | | |
| | Intercept Drains – Perforated: | | | |
| 34 | Up gradient | 15 | 15 | 15 |
| 35 | Laterally | 25 | 50 | 50 |
| 36 | Down gradient | 25 | 50 | 50 |
| | Intercept Drains --Non-Perforated | | | |
| 37 | Up gradient | 5 | 10 | 10 |
| 38 | Laterally | 10 | 15 | 15 |
| 39 | Down gradient | 10 | 15 | 15 |
| | Intercept Drains Outlets by Discharge Location | | | |
| 40 | Stream | Note 8 | Note 8 | Note 8 |
| | Drainage Way | Note 8 | Note 8 | Note 8 |
| | Storm Drain Pipe | Note 8 | Note 8 | Note 8 |
| | Storm Water Treatment Facility | Note 8 | Note 8 | Note 8 |
| | Earth/ground with erosion protection, rip-rap, energy or flow dissipater | 15 | 15 | 25 |
| | Cut banks (manmade excavation of the natural terrain greater than 3 feet), natural bluffs, sharp changes in slope. | | | |
| 41 | Upgradient and downgradient for soil or groundwater depth below dispersal area is greater than or equal to 5 feet . | 25 | 25 | 25 |
| 42 | Upgradient and downgradient for soil or groundwater depth below dispersal area is less than 5 feet . | 50 | 50 | 50 |
| 43 | Lateral setback regardless of soil/groundwater depth. | 25 | 25 | 25 |

| | Minimum horizontal distance required from: | Septic Tank (All Systems) (feet) ¹ | Dispersal Area (Standard) (feet) ^{1,2} | Dispersal Area (Non Standard) (feet) ^{1,2} |
|----|--|---|---|---|
| | Miscellaneous Features: | | | |
| 43 | Dispersal field | 5 | — | — |
| 44 | Title 22 recycled water dispersal area | 5 | Per RWQCB | Per RWQCB |
| 45 | Distribution box | 5 | 4 | — |
| 46 | Fill areas | — | 15 | 15 |
| 47 | Large trees | 10 | Considered on a case by case basis | Considered on a case by case basis |
| N1 | 1: Use Lateral distances when terrain gradient is 1% or less. | | | |
| N2 | 2: See Table 7.2d for point of measurement by system type. | | | |
| N3 | 3: Septic tank and sump shall be watertight. | | | |
| N4 | 4: Bottom of water pipe shall be greater than or equal to 12 inches above the top of sewer/drain line. Water pipe placed on a solid shelf excavated at one side of the common trench with a minimum horizontal distance of greater than or equal to 12 inches (2022 California Plumbing, per Section 720.1(1), or most current version.) | | | |
| N5 | 5: As measured from the top of natural or levied bank. Refer to DRN-005 for irregular bank slopes (Figure 1(e)) and for undefined banks (Figure 1(f)). | | | |
| N6 | 6: Measured from the high waterline. | | | |
| N7 | 7. The setback may be greater or less if it is supported in a wetlands report, prepared by a qualified biologist or | | | |
| N8 | 8: The setback is from where intercept drain daylights into the storm water infrastructure (a stream, drainage way, storm drain, etc). The setback distance is equal to the distances listed under the Streams/Waterways/Water Bodies section (rows 15 through 22) or the Storm Water Infrastructure section (rows 23 through 33) depending on the type of storm water conveyance system being used. | | | |
| N9 | 9: Transmission lines from tanks to dispersal area shall maintain setbacks specified for septic tanks except where otherwise determined by the 2022 California Plumbing Code, per Table 721.1, or most current version. | | | |

**Table 7.2d
Setback Distance Point of
Measurement by System Type**

| System Type | Point of Measurement |
|--|--------------------------------|
| Standard Dispersal Trench | |
| Upgradient | Edge of trench |
| Laterally | Edge of trench |
| Downgradient | Edge of trench |
| Gravel-less Field Systems | |
| Upgradient | Edge of trench |
| Laterally | Edge of trench |
| Downgradient | Edge of trench |
| Filled Land Systems | |
| Upgradient | Edge of trench |
| Laterally | Edge of trench |
| Downgradient | Edge of trench |
| Shallow Sloping OWTS ¹ | |
| Upgradient | Edge of the trench |
| Laterally | Edge of the trench |
| Downgradient | 25 feet from edge of trench |
| Mound OWTS: Sloped Sites | |
| Upgradient | Upslope edge of the gravel bed |
| Laterally | Edge of the gravel bed |
| Downgradient | Edge of the gravel bed |
| Mound OWTS: Level Sites | |
| Upgradient | Edge of the sand bed |
| Laterally | Edge of the sand bed |
| Downgradient | Edge of the sand bed |
| Pressure Distribution (PD) OWTS | |
| Upgradient | Edge of trench |
| Laterally | Edge of trench |
| Downgradient | Edge of trench |
| At-Grade OWTS: Sloped or Level | |
| Upgradient | Edge of the gravel bed |
| Laterally | Edge of the gravel bed |
| Downgradient | Edge of the gravel bed |
| Shallow In Ground (SIG) OWTS | |
| Upgradient | Edge of trench |
| Laterally | Edge of trench |
| Downgradient | Edge of trench |
| Drip Dispersal OWTS ² | |
| Upgradient | Perimeter of drip line |
| Laterally | Perimeter of drip line |
| Downgradient | Perimeter of drip line |

| System Type | Point of Measurement |
|--|---|
| Bottomless Sand Filter OWTS | . |
| Upgradient | Edge of support structure containment enclosure |
| Laterally | Edge of support structure containment enclosure |
| Downgradient | Edge of support structure containment enclosure |
| Gravel-less Pressurized Dispersal | |
| Upgradient | Edge of trench. |
| Laterally | Edge of trench. |
| Downgradient | Edge of trench. |
| Experimental Systems not listed | Dependent upon review of specific systems |
| | |
| N1: Shallow Sloping System | The downslope area for filled land and shallow sloping systems shall not be encroached upon. These systems rely on the downslope soil profile for effluent treatment. |
| N2: Drip Dispersal | Use edge of fill when drip tubing is place at grade. |

7.3 Soil Profile/Groundwater/Percolation Test Notification

- A. Section 7.3 applies to subdivisions and development projects with more than four dwelling units on one parcel. All other project types are not subject to section 7.3.
- B. The property owner or Qualified Consultant shall make the appointment with the Permit Authority and to schedule the preliminary soil profile evaluation, percolation test and/or groundwater determination. A Sonoma County Request for Service Form shall be filled out and the filing fee shall be submitted at this time. A copy of the Assessor's Parcel Map, one plot plan and a vicinity map shall be submitted with the Request for Service form and the parcel shall be clearly marked in the field.
- C. The Permit Authority Well and Septic Section shall be notified a minimum of 24 hours in advance to schedule (on a normal working day before 12:00 noon) profile hole preparation, any percolation testing, backhoe excavations, groundwater determination testing and/or other site evaluation that is being attempted.
- D. The Qualified Consultant is responsible for requesting the soil percolation test.
- E. The Qualified Consultant may choose to perform the soil percolation test and the soil profile evaluation at the same time. Combining these two steps must be authorized by the Permit Authority in advance of the work.
- F. All soil texture analysis, soil profiles, percolation tests, groundwater determination tests, and information obtained related to the percolation test procedures shall be submitted to the Permit Authority Well and Septic Section within 90 days of the completion of all on-site testing. This includes any test information data or results that may not prove acceptable for sewage dispersal design (extensions may be requested on a case-by-case basis).

7.4 Soil Profile Evaluations

- A. Soil profile holes for the Preliminary Site Survey Soil Profile Evaluation typically are constructed prior to any soils percolation testing and/or groundwater determination tests.
 - 1. Wet weather percolation testing and/or groundwater determination tests prior to soil profile evaluations are allowed; however, the tests are considered incomplete, pending approval of the soil profile investigation.
- B. Profile holes must be adequately covered to prevent entrance if left unattended and backfilled immediately after completion of test procedures. Note: Work is permissible on sites to locate potentially acceptable areas prior to the preliminary evaluation.
- C. Soil profiles holes are for the purpose of observing soil structures, texture, formations; the presence of seasonal groundwater; impervious rock formations, etc. Profiles are essential in the evaluation of any parcel for soil suitability for private sewage dispersal systems.
- D. A minimum of two soil evaluations (profile pits or holes) are required in the Site Evaluation Area. Additional soil evaluations (profile pits or holes) may be required to demonstrate suitable soil conditions for both the primary dispersal area and the reserve replacement area for the following reasons including, but not limited to:
 - 1. dissimilar or inconsistent soil conditions, enough to alter the ultimate design, are observed in the initial two profile holes;
 - 2. the size of the proposed system warrants additional soil profiles; or,
 - 3. downslope permeability needs to be demonstrated as required on the system type.
- E. The profile holes shall be dug to a depth of at least three feet below the proposed absorption surface trench bottom or two feet below the basal area of a mound.
 - 1. Soil depth is measured vertically to the point where bedrock, hardpan, impermeable soils, rock content greater than 50 percent, or saturated soils are encountered.
 - 2. For soils having less than 15 percent silt and clay, the minimum depth to groundwater below the leaching trench shall be five feet.
 - 3. For soils having greater than 15 percent silt and clay, the minimum soil depth and depth to groundwater below the leaching trench shall be three feet.
 - a. Lesser soil depths may be granted only as a variance or for Non-Standard Alternative OWTS.
- F. Soil profile pits shall be excavated with a backhoe. Augured or hand dug profile holes are an acceptable alternative only:
 - 1. when physical access prevents the use of a backhoe;
 - 2. to supplement prior soils investigations; or,
 - 3. in conjunction with geologic investigations.
- G. Soil texture shall be determined using the “The Feel Method for Soil Texturing” method.

H. Hydrometer Testing.

1. To justify a proposed OWTS, a soil hydrometer test shall be taken from each soil horizon(s) in each profile pit(s) or hole(s) used for the OWTS design. The soil samples shall be submitted to a certified laboratory for testing. Results shall be submitted with OWTS Design Report and OWTS Application.
 2. Each soil hydrometer test results shall be charted on the Soil Texture Triangle Chart.
 3. The Hydrometer Test Data Form shall be filled out completely with particular attention to the plasticity index, the bulk density, the soil profile hole or pit number and the depth for each soil horizon sampled and tested.
 4. The Qualified Consultant shall make the applicable adjustments for bulk density and coarse fragments according to the instructions for the Soil Percolation Suitability Chart, Figure 4.2.
- I. The soils shall be classified into zones as shown in the USDA Soils Classification Triangle. The USDA Soils Classification Triangle shall be the primary reference on acceptability of soils for OWTS. (see Figure 7.4). The following factors are to be observed and reported from ground surface to a depth corresponding to the groundwater determination and soil percolation test requirements:
1. Thickness and coloring of soil layers, structure and texture using the United States Department of Agriculture (USDA) classification;
 2. Soil layer(s);
 3. Depth to observed groundwater, saturated soil layers and areas of water infiltration;
 4. Depth to soil mottling;
 5. Other prominent soil features such as structure, consistency, stoniness, presence and quantity of roots and pores, dampness, soil boundaries, etc.
 6. Limiting condition(s).

**Figure 7.4
Soil Percolation Suitability Chart for OWTS**

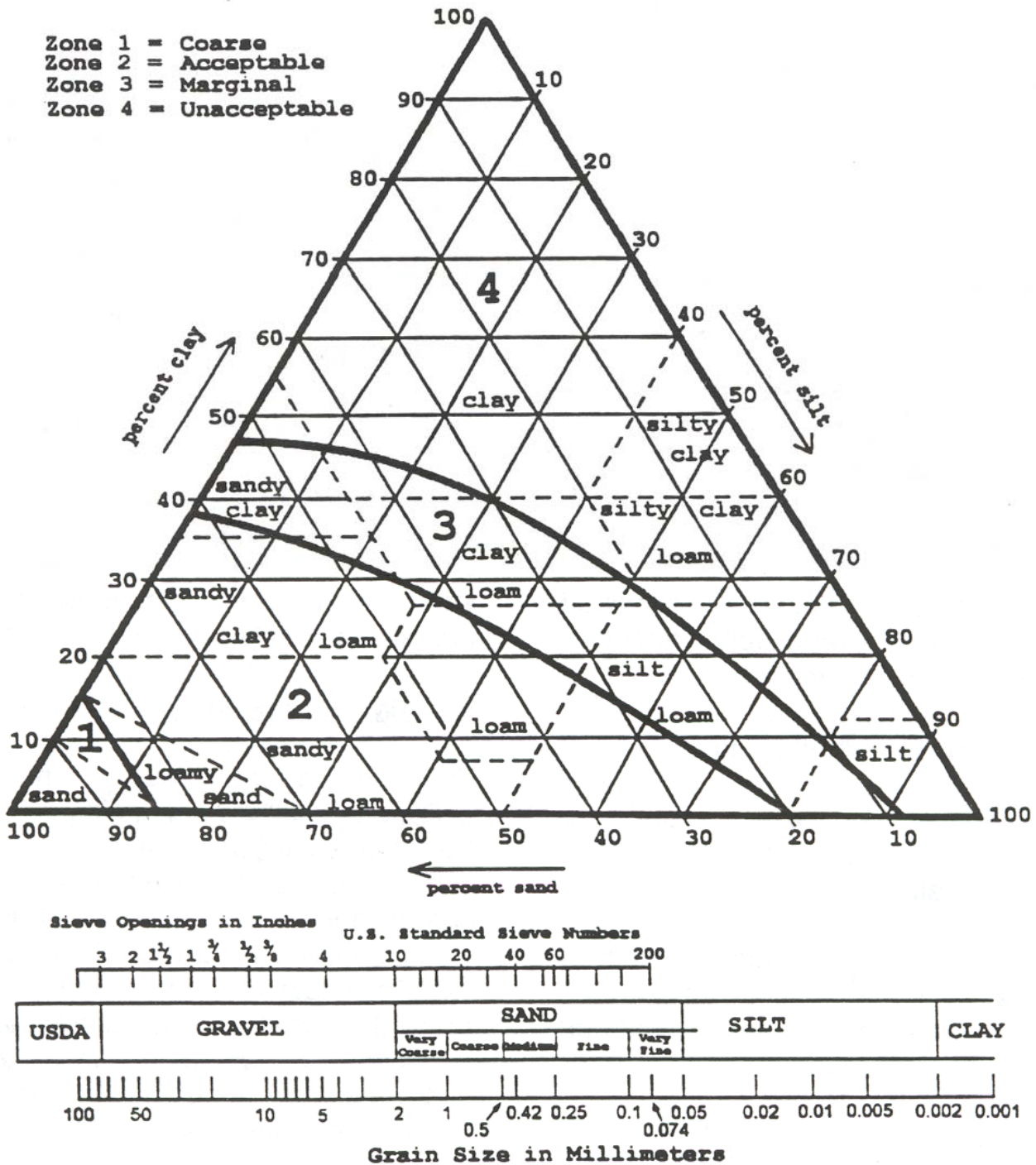

Instructions:

1. Plot texture on triangle based on percent sand, silt, and clay as determined by hydrometer analysis.
2. Adjust for coarse fragments by moving the plotted point in the 100 percent sand direction an additional 2 percent for each 10 percent (by volume) of fragments greater than 2 millimeters in diameter.
3. Adjust for compactness of soil by moving the plotted point in the 100 percent clay direction an additional 15 percent for soils having a bulk density greater than 1.7 grams per cubic centimeter.

Note: For soils falling in sand, loamy sand, or sandy loam classification, bulk density analysis will generally not affect suitability, and analysis is not necessary

7.5 Groundwater Elevation Observations

A. General Provisions

1. Groundwater elevation determinations are required for sites having slopes of less than or equal to five percent. Groundwater elevation determinations may be required for sites having slopes greater than five percent if high seasonal groundwater is known or suspected in the site vicinity.
2. A minimum of two groundwater elevation observations (more may be required depending on anticipated OWTS dispersal area size) are required in the Site Evaluation Area. The groundwater elevations shall support a consistent design type, shall be spaced to encompass the entire future design areas (both primary and reserve). Site conditions and type of anticipated septic system will determine the required number of holes for the tested area.
3. In situations where past groundwater elevations have been observed too close the ground surface for a particular OWTS, an interceptor drain, or a surface water diversion may allow for retesting of the site. This may require supplemental soil profile test holes to verify soil conditions in the alternate area. If drainage improvements are to be made in advance of the septic installation, plans for these improvements shall be submitted to the Well & Septic section. A separate permit may be required for the installation of an interceptor drain that is not part of a septic permit.

B. Groundwater Elevation Observation Methods

Groundwater elevation observations can be made by one of following methods:

1. Direct observations via backhoe pits or auger holes;
2. Direct observation via existing water wells or monitoring wells;
3. Indirect observation via soil mottling; or
4. Compilation of approved readings or observations from any of the first three methods from adjacent or neighboring parcels and/or projects.
5. Other alternate methods as approved by the Permit Authority.
6. When groundwater elevation observation data exists from multiple sources or methods, the data showing the groundwater elevations closest to the ground surface shall govern the design of the OWTS. The Permit Authority may allow additional direct groundwater elevation observations or other scientific methods to verify potential false mottling situations.

C. Direct Groundwater Elevation Observation Calendar

1. Direct groundwater elevation observations shall be conducted between January 1 and March 1, after having received 50 percent of the average seasonal rainfall for each defined geographic area, as listed in Table 7.5 and depicted in Map 7.5, and within 10 days of receipt of 0.8 inch or more of rainfall within a 48-hour period as reported by the officially recognized reporting stations, as published in the Press Democrat.
2. Time extensions for direct groundwater elevation determinations may be authorized by the Permit Authority based on extended periods of rainfall before January 1 and/or after March 1.

D. Direct Groundwater Elevation Observation Construction Methods

1. The preferred method of construction is by hand auguring or digging by hand, however, in some situations the depth of the hole may require the use of a backhoe or a drill rig to construct.
2. The test holes shall be constructed at depths to determine the highest anticipated groundwater level below the proposed trench bottom and /or absorption surface area.
3. If the proposed system design is to be above an impermeable soil layer, the test holes must be placed above the impermeable soils layer. If the system design is proposed below an impermeable soil layer, then the test hole must be placed below the impermeable soil layer. The testing shall correlate with the soils evaluation and proposed system design.
4. The minimum diameter of the perforated pipe shall be three inches.
5. Backhoe excavated profile holes remaining open shall be adequately supervised or barricaded until observed.
6. An alternative to leaving the holes open, is to insert a perforated pipe in the hole and place native backfill around the pipe (the backfill shall not be compacted).
7. Groundwater holes shall be protected to prevent sheet flow runoff, rainfall or other sources of non-groundwater from entering the observation hole.

E. Direct Groundwater Elevation Measurements and Reporting

1. The observation hole shall remain in place and undisturbed for a minimum of 24 hours prior to observation or measurements to allow infiltration of groundwater. Holes prepared too far in advance of the observation may be impacted by silting effect, damage to the pipes, and other factors that affect the accuracy of the readings.
2. Qualified Consultant shall measure and record the depth to groundwater from the undisturbed or pre-existing ground surface to the nearest ½ inch.
3. Groundwater averaging is not appropriate for one day readings.

F. Indirect Groundwater Elevation Determination Method

1. Soil mottling observations may be utilized as an alternative to direct wet weather groundwater table determinations when the Qualified Consultant and the Permit Authority staff agree the on-site soil characteristics that lend themselves to redoximporhic processes are present and the presence or absence of soil mottling can be determined.
2. Soil mottling observations shall not be utilized for properties with failed or canceled groundwater determinations on file.
3. A soil profile evaluation of sufficient means to determine the observable depth of soil mottling is required for this procedure.
4. Soil mottling or the absence of soil mottling shall be observed and documented by the Qualified Consultant and Permit Authority staff. If not combined with the Pre-Perc meeting, the field procedure will be similar to a Pre-Perc where the Qualified Consultant shall schedule a time to meet on site with the Permit Authority staff and shall coordinate the excavation and backfilling of soil profile pits.

G. Compilation Method

The compilation method may be used provided the following criteria are met:

1. Soil profile readings or observations are within 500 feet of the proposed OWTS; and,
2. Area conditions lend themselves towards using off-site data or data not directly associated with the proposed OWTS. Area conditions include, but are not limited to, topography, slope, geology, geography, cut banks, natural bluffs, rock outcrops, landslides, springs, streams, roads; and,
3. Soil profile readings or observations were made by both a Qualified Consultant and the Permit Authority and site conditions have not changed to render the readings or observations invalid; and,
4. Soil profile readings or observations have been submitted and approved by the Permit Authority.

H. Conflicts Between Methods

Where a conflict in the above methods exists, the Permit Authority shall decide the appropriate method. Considerations shall include soil characteristics, rainfall and/or drought conditions, historical records and written reports.

- I. Table 7.5, below, presents 50 percent of the average annual rainfall by Wet Weather Zone

**Table 7.5
50 Percent of Average Annual Rainfall by Zone**

| Wet Weather Zone | 50 Percent of Annual Rainfall |
|----------------------|-------------------------------|
| Petaluma (Area A) | 12.5 inches |
| Sonoma (Area B) | 15 inches |
| Santa Rosa (Area C) | 15 inches |
| Sebastopol (Area D) | 17.5 inches |
| Guerneville (Area E) | 25 inches |
| Healdsburg (Area F) | 20 inches |
| Cloverdale (Area G) | 20 inches |

Map 7.5 Wet Weather/Groundwater Determination Zones

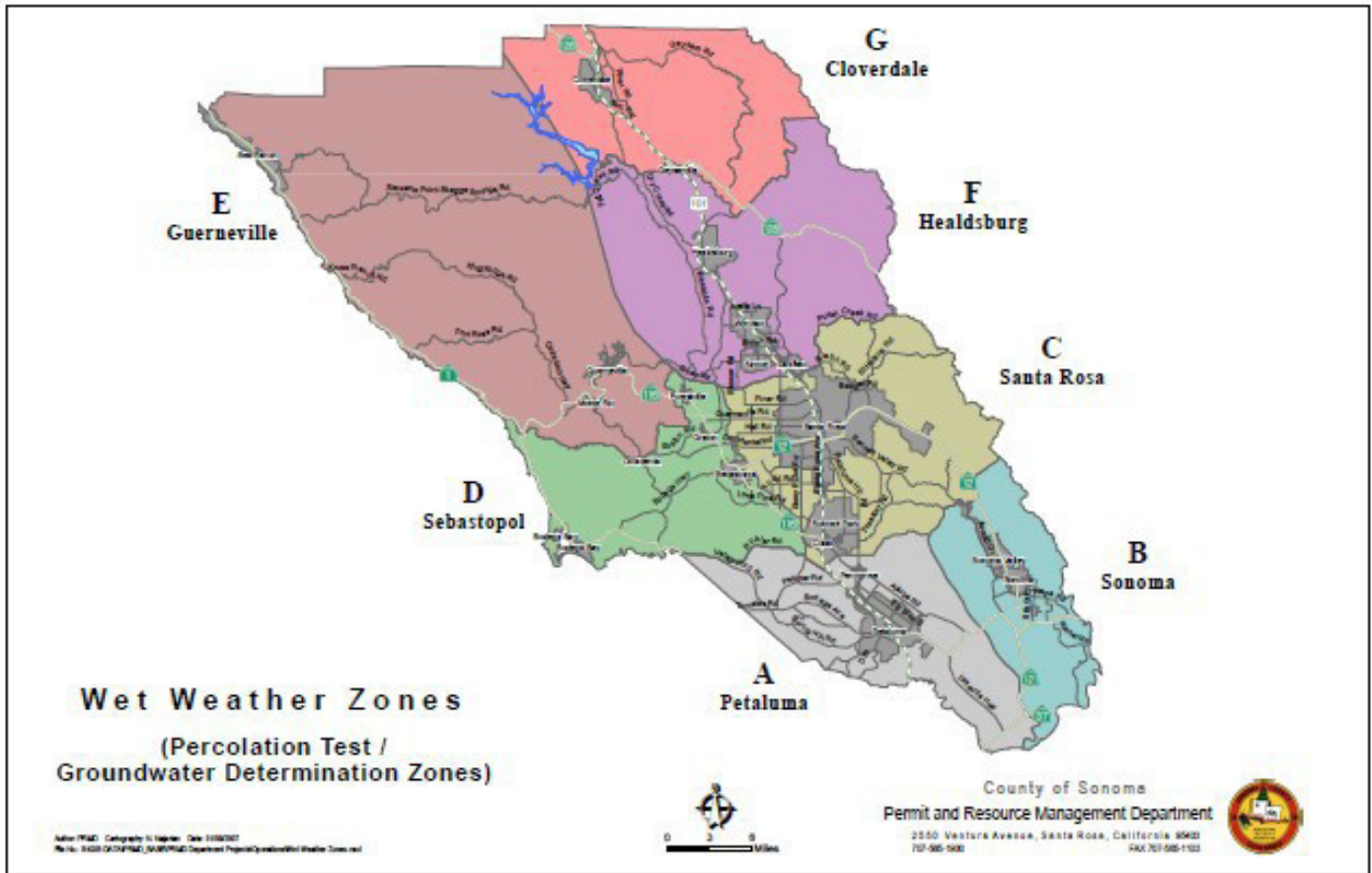

7.6 Soil Percolation Evaluations

- A. For undeveloped properties, soil percolation testing is required pursuant to Table 7.6.A.
 1. For undeveloped properties, the site suitability for effluent dispersal shall be determined by soil profile and percolation testing.
 2. For undeveloped properties, soil profiles along with a wet or dry weather percolation test shall be used for zone one or zone two soil types.
 3. For undeveloped properties, soil profiles along with percolation tests shall be required for zone three and zone four soils. A dry weather percolation test may be used for soils with a plasticity index of less than 20, otherwise a wet weather percolation test shall be used.

**Table 7.6A
Un-Developed Property Percolation Test Method**

| Soil Zone | Plasticity Index | Test Method |
|---------------|---|----------------------------------|
| One or Two | Not Applicable | Dry (or Wet) Weather Percolation |
| Three or Four | Less than twenty (< 20) | Dry (or Wet) Weather Percolation |
| Three or Four | Greater than or equal to twenty (>=20) | Wet Weather Percolation Test |

- B. For developed properties, soil percolation testing or soil hydrometer analysis is required pursuant to Table 7.6.B.
1. For developed properties, the site suitability for effluent dispersal shall be determined by soil profile, percolation test and/or by soil texture hydrometer analysis.
 2. For developed properties, soil profiles along with soil texture hydrometer analysis may be used for zone one or zone two soil types.
 3. For developed properties, soil profiles along with percolation tests shall be required for zone three and zone four soils. A dry weather percolation test may be used for soils with a plasticity index of less than 20, otherwise a wet weather percolation test shall be used.

**Table 7.6B
Developed Property Percolation Test Method**

| Soil Zone | Plasticity Index | Test Method |
|---------------|---|----------------------------------|
| One or Two | Not Applicable | Soil Hydrometer Analysis |
| Three or Four | Less than twenty (< 20) | Dry (or Wet) Weather Percolation |
| Three or Four | Greater than or equal to twenty (>=20) | Wet Weather Percolation |

- C. The plasticity index shall be determined using ASTM D 4318-17e1 or the plasticity index shall be assigned a value of greater than or equal to 20 and percolation testing shall be required per Table 7.6.A or Table 7.6.B.
- D. A minimum of six percolation test holes are required in the Site Evaluation Area. Additional percolation test holes may be required to demonstrate suitable soil conditions for the following reasons including, but not limited to:
1. additional expansion area is required;
 2. downslope permeability needs to be demonstrated;

3. the size of the proposed system warrants additional percolation test holes; or,
 4. the OWTS Manual design standards for the specific OWTS require additional percolation test holes.
- E. Additional requirements, determined on an individual basis, may be required for specially designed or non-standard on-site sewage dispersal systems when permitted.

7.7 Percolation Test Hole Construction

A. Percolation test hole construction requirements are as follows:

1. Percolation test hole diameters shall be four to eight inches in diameter.
2. Percolation test holes shall be excavated or bored.
3. Percolation test hole(s) shall be to the vertical depth of the proposed trench and/or to the vertical depth of the dispersal field. Percolation test hole(s) shall be placed at additional depth(s) when soil horizons are expected to have a slower percolation rate or are required in order to demonstrate permeability of a particular system type. See Table 7.7 for example percolation test hole depths.
4. Percolation test hole pipe shall be perforated pipe either three or four inches in diameter.
5. After a percolation test pit or hole is dug, remove all loose material possible after carefully scraping the bottom and sides to remove any smeared soil surfaces. At the bottom of any backhoe excavations used, a secondary four to eight-inch diameter hole is to be bored to the depth of the proposed trench in undisturbed soil, providing that the depth shall not be less than 12 inches. Add clean pea-gravel (maximum of one inch) to stabilize the hole, insert the percolation test pipe and place pea-gravel around exterior of pipe 12 inches in depth. Do not back fill soil around pipe in backhoe holes. Measure and record the length of the pipe on the report form.

Table 7.7 – Site Parameters by System Type

STANDARD OWTS

| | Perc Depth Minimum | Perc Rates | Soil depth ¹ | Separation to Groundwater ² | Downslope Soils |
|--------------------------------|--|--|---|---|---|
| Standard Trench | Trench bottom ³ ; sidewall; below trench bottom | Trench bottom; sidewall 1-60 MPI Section 9.1.B Below trench bottom 1-120 MPI Section 9.1.C | 3 feet: For soils with greater than 15% silt and clay. 5 feet: For soils having less than 15% silt and clay. | 3 feet: For soils with greater than 15% silt and clay. 5 feet: For soils having less than 15% silt and clay | N/A |
| Gravel-less Drain Field | Trench bottom ³ sidewall; below trench bottom | Trench bottom Sidewall 1-60 MPI Section 9.5A Below trench bottom 1-120 MPI Section 9.5.A | 3 feet: For soils with greater than 15% silt and clay. 5 feet: For soils having less than 15% silt and clay. | 3 feet: For soils with greater than 15% silt and clay. 5 feet: For soils having less than 15% silt and clay. | N/A |
| Filled Land | Trench bottom ³ sidewall; below trench bottom | Trench bottom sidewall 1-60 MPI Section 9.6.A.5 Below trench bottom 1-120 MPI Section 9.6.A.5 | 3 feet: For soils with greater than 15% silt and clay. 5 feet: For soils having less than 15% silt and clay. | 3 feet: For soils with greater than 15% silt and clay. 5 feet: For soils having less than 15% silt and clay. | N/A |
| Shallow Sloping | Trench bottom ³ side wall | Trench bottom sidewall 1-60 MPI Section 9.7.A.4 Rates between 1- 5 MPI require additional evidence that breakout will not occur. | 50 feet of permeable, horizontal soil or downslope soil | 3 feet. | Downslope soils as shown by one perc at 25' and one perc at 50' downslope of lowest leach line. |

| | | | | | |
|---------------------------------------|---|--|--|---|-----|
| Standard Pressure Distribution | Trench bottom ³ sidewall; below trench bottom | Trench bottom sidewall 1-60 MPI Section 9.8.A.1 Below trench bottom 1-120MPI | 3 feet: if soils with greater than 15% silt and clay. 5 feet: for soils having less than 15% silt and clay. | 3 feet: for soils with greater than 15% silt and clay. 5 feet: for soils having less than 15% silt and clay. | N/A |
|---------------------------------------|---|--|--|---|-----|

NON-STANDARD ALTERNATIVE OWTS

| | Perc Depth Minimum | Perc Rates | Soil depth | Separation to Groundwater² | Downslope Soils |
|---|---|---|--|---|--|
| Mound | 24 inches ³ | 1-120 MPI Section 13.4.B.1 | 2 feet Pretreatment does not mitigate 1 foot of soil | 2 feet Pretreatment does not mitigate depth to groundwater | 24 inches no less than 25 feet downslope from the sand perimeter |
| Shallow Trench Pressure Distribution | Trench bottom ³ | 1-120 MPI Section 13.4.B.1 Rates between 1- 5 MPI requires pretreatment Section 13.4.C.3.b.ii | 2 feet Pretreatment does not mitigate 1 foot of soil | 2 feet Pretreatment does not mitigate depth to groundwater | 24 inches below emitter depth no less than 25 feet downslope from the edge of the last proposed trench |
| At-Grade | 36 inches ^{3,4} or 24 inches with pretreatment ³ | 1-120 MPI Section 13.5.B.2 Rates between 1- 5 MPI; Slower than 90 MPI Pretreatment Required Section 13.5.B.2 | 3 feet 2 feet with pretreatment | 3 feet 2 feet with pretreatment | 36 inches or 24 inches with pretreatment no less than 25 feet downslope |
| Shallow in Ground (SIG) | Trench bottom ⁴ and 24 inches and 36 inches below trench depth | 1-120 MPI Rates between 1- 5 MPI; Slower than 90 MPI Pretreatment Required Section 13.6.C.3 | 3 feet and 4 feet to bedrock 2 feet with pretreatment | 3 feet 2 feet with pretreatment | N/A |
| Subsurface Drip | Twenty four inches below proposed drip tubing depth ^{3,4} | 1-120 MPI Section 13.7.B.1; 13.7.B.2 < 1 MPI with disinfection Section 13.7.C.16 | 2 feet | 2 feet | 24 inches below emitter depth no less than 25 feet downslope |
| At-Grade Surface Drip | Twenty four inches below proposed drip tubing depth ^{3,4} | 1-120 MPI < 1 MPI with disinfection Section 13.7.C.16 | 2 feet | 2 feet | 24 inches below emitter depth no less than 25 feet downslope |

NON-STANDARD EXPERIMENTAL

| | Perc Depth | Perc Rates | Soil depth ¹ | Separation to Groundwater ² | Downslope Soils |
|---|---|---|--|--|-----------------------------|
| Bottom less Sand Filter | 24 inches ³ Section 13.1 | 1-120 MPI Section 13.1 | Section 13.1 | Section 13.1 | Section 13.1 |
| Gravel-less Pressurized Dispersal Channel (GPDC) | Trench bottom ³ and 24 inches below trench bottom. Section 13.2.B.2 | 1-120 MPI Section 13.2 B.1; 13.2.B.2 < 1MPI with disinfection. Section 13.2.B.14 | 2 feet and requires packed bed media filter supplemental treatment, NSF Standard 40. | 2 feet | 24 inches 25 feet downslope |

1: Soil Depth is below dispersal system or trench

2: Separation to Groundwater is below dispersal system or trench bottom

3: If the soil types are dissimilar enough to affect the ultimate design of the system then additional percolation testing may be required to demonstrate 1) permeability at shallower soil depths/horizons, 2) required soil depth and/or 3) sidewall permeability

4 . Percolation rates are based on most restrictive soil horizon tested, in conjunction with soil profile information (structure, pores, roots, bulk density).

Figure 7.7a Percolation Test Hole Requirements

Typical Percolation Test Hole

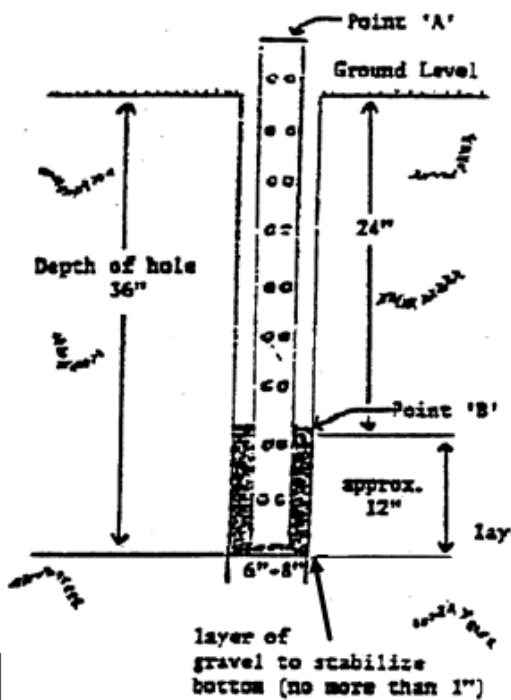

Materials needed to conduct a percolation test:

1. Three or four inch diameter perforated pipe.
2. Fine gravel (pea).
3. Metal tape measure.
4. Six or eight inch soil auger.
5. Water supply.

Measurements:

1. Record length of pipe and depth of hole.
2. Record presoak remaining to the nearest one-eighth inch (from top of pipe to top of water).
3. Record measurements from Point "A" to Point "B" (from top of pipe to top of water).
4. Adjust water level to 12 inches above gravel at bottom of hole.

Note: The depth of the percolation hole will vary according to slopes on site, and whether the system proposed is a standard or non-standard system.

Figure 7.7b
Percolation Test Hole

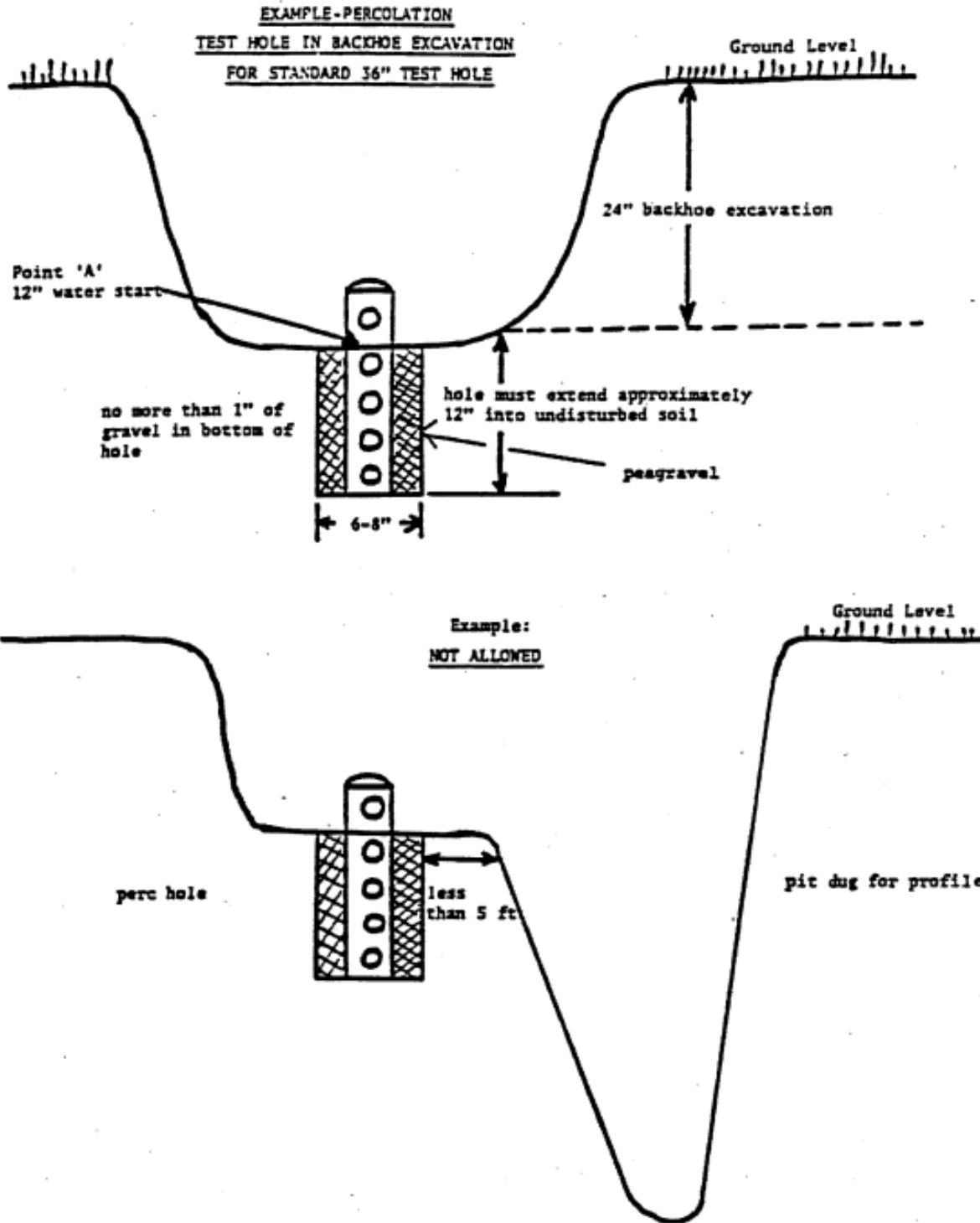

7.8 Percolation Test Procedures

- A. Presoak on the day prior to conducting the tests, fill the holes completely with clear water to which no substances have been added and refill at least four times. An alternate procedure is a continuous 12-hour presoaking employing a reservoir and continuous head device. Presoaking for wet-weather tests is not necessary if the tests are performed during the 10-day period in which wet-weather groundwater determinations are allowed.
- B. Percolation Rate Measurements. Percolation-rate measurements shall be made on the day following the presoaking of test holes.
1. Presoak remaining in 24-inch deep percolation test holes may indicate lack of soil depth.
 2. When water remains from presoaking, record the inches of water remaining on the report form and adjust the water level to 12 inches over the gravel base.
 3. Measurements are then taken from a fixed point at the top of the pipe to the top of the water and like measurements taken each hour for six hours. Record measurements accurately, vertically, and to the nearest 1/8 inch.
 4. When no water remains from presoaking, gently add clear water to the hole to a depth of 12 inches over the gravel base. Measure the drop in the water level from a fixed point at the top of the pipe to the top of the water each hour for six hours. Additional water may be added to 12 inches above the gravel when the hole is empty, or after any reading that indicates the water is less than two inches above the gravel. Record the new water elevation and continue measurements for duration of initial six-hour test. Record measurements to the nearest 1/8 inch.
 5. When hole is dry before the first 60 minutes upon start of test measurements, add clear water to 12 inches over the gravel base and take measurements every 10 minutes for two hours. The 12 inches of water is to be replaced at any time the hole is empty or the water depth is less than two inches.

7.9 Percolation Rate Interpretation

- A. For six-hour tests, the drop in water level that occurs between the fifth and sixth measurements is considered to be the stabilized percolation rate.
- B. For two-hour, 10 minute tests, the drop in water level that occurs between the eleventh and twelfth measurements is considered to be the stabilized rate.
- C. For test holes that require refilling in the last two hours for a six-hour test or in the last 10 minutes for a two-hour test, the stabilized percolation rate can be determined by:
1. Direct measurement upon refilling,
 2. Interpreting prior readings, or
 3. Assuming a zero minutes per inch rate.
- D. For each percolation test depth or soil horizon, a system percolation rate shall be established by averaging the individual stabilized percolation rates within the proposed dispersal area.
- E. Individual stabilized percolation rates less than one minute per inch are not suitable for the installation of an OWTS and are not to be included in the system percolation rate.

1. Exception:

Individual stabilized percolation rate less than one minute per inch may be allowed with a drip system pursuant to sections 13.7, or a gravel-less pressurized dispersal channel pursuant to section 13.2.

Percolation rates less than one minute per inch require a soil texture analysis (hydrometer method) to determine the necessary clearance from the proposed trench bottom or point of discharge to elevated seasonal water table, unless well logs demonstrate the distance to water table to be 40 feet or greater. If soil texture analysis is performed, required soil depth and depth to the groundwater table shall be as specified in Section 7.4 E.

- F. Individual stabilized percolation rates from one to less than five minutes per inch require a soil texture analysis (hydrometer method) to determine the necessary clearance from the proposed trench bottom to elevated seasonal water table, unless well logs demonstrate the distance to water table to be 40 feet or greater. If soil texture analysis is performed, required soil depth and depth to the groundwater table shall be as specified in Section 7.4 E.
- G. Individual stabilized percolation rates from one to 60 minutes per inch in the effective soil dispersal area (sidewall and trench bottom) is required for installation of standard OWTS.
- H. Individual stabilized percolation rates of greater than 60 to 120 minutes per inch is required for Non-Standard OWTS at the specified dispersal area depths. Standard systems are acceptable in this range with proof of soil permeability and soil depth below trench bottom.
- I. Individual stabilized percolation rates greater than 120 minutes per inch are not suitable for septic system designs.

**Table 7.9A
Individual Percolation Rates by System Type**

| Individual Percolation Rates (Minutes per inch) | Nonstandard System Types | Standard System Types |
|---|--|--|
| <1 | Not suitable ¹ | Not suitable |
| 1 to < 5 | Suitable. Requires soil hydrometer texture analysis to determine required depth of soil and depth to seasonal groundwater measured from trench bottom or dispersal pipe per section 7.4.E. ² | Suitable. Requires soil hydrometer texture analysis to determine required depth of soil and depth to seasonal groundwater measured from trench bottom or dispersal pipe per section 7.4.E. ² |
| 1 to 60 | Suitable | Suitable |
| > 60 to 120 | Suitable | Suitable only for proof of soil permeability and depths below trench bottom |
| > 120 | Not suitable | Not suitable |
| 1. May only be considered for drip systems pursuant to sections 13.7 or a gravel-less pressurized dispersal channel pursuant to section 13.2. | | |
| 2. Unless data from well logs demonstrates the distance to the seasonal water table to be 40 feet or greater. | | |

**Table 7.9B
Percolation Rate Conversion Chart**

| Inches per Hour | Rate Minutes per Inch | Inches per Hour (Continued) | Rate Minutes per Inch (Continued) |
|-----------------|-----------------------|-----------------------------|-----------------------------------|
| 1/8 | 480 | 2 3/4 | 22 |
| 1/4 | 240 | 3 | 20 |
| 3/8 | 160 | 3 1/4 | 18 |
| 1/2 | 120 | 3 1/2 | 17 |
| 5/8 | 96 | 3 3/4 | 16 |
| 3/4 | 80 | 4 | 15 |
| 7/8 | 69 | 5 | 12 |
| 1 | 60 | 6 | 10 |
| 1 1/8 | 53 | 7 | 9 |
| 1 1/4 | 48 | 8 | 8 |
| 1 3/8 | 44 | 9 | 7 |
| 1 1/2 | 40 | 10 | 6 |
| 1 5/8 | 37 | 12 | 5 |
| 1 3/4 | 34 | 15 | 4 |
| 1 7/8 | 32 | 20 | 3 |
| 2 | 30 | 39 | 2 |
| 2 1/4 | 27 | 60 | 1 |
| 2 1/2 | 24 | | |

7.10 Wet Weather Percolation Tests

- A. Wet weather percolation testing shall be required pursuant to Section 7.6.
- B. Wet weather soils percolation tests are percolation tests conducted between January 1 and March 1 after having received 50 percent of actual seasonal rainfall for each defined geographic area. (See Section 7.5, Table 7.5 and, Map 7.5.)
- C. Extensions beyond the time limits of the above criteria may be made by the Engineering Program Manager of the Permit Authority based on an evaluation of rainfall and groundwater monitoring and within the parameters of this section. Extensions beyond April 30 are not allowed.
- D. Presoaking for wet weather tests is not necessary if the tests are performed during the period in which weather groundwater determinations are allowed.

7.11 Percolation Test Submittal of Results

- A. Percolation test information shall be submitted with the OWTS Application to the Permit Authority on the County form provided for all tests conducted including preliminary tests, failing holes and exploratory holes which were not tested.
- B. All percolation test records submitted for approval of a site must be complete and shall include a written evaluation attesting to the validity of all tests by a RCE, Registered Geologist, Soil Scientist or REHS experienced in on-site sewage dispersal systems. Records and evaluations submitted are to include at a minimum:
 - 1. Data on all excavations, including failing holes and exploration holes within a 100-foot radius of the proposed septic area which was not tested.
 - 2. Size of land area available for primary dispersal system and required replacement area, including a scaled plot plan showing the location of test holes dimensioned to property lines and delineating the area for the dispersal fields as calculated from the established percolation rate.
 - 3. Accurate ground slope in the primary and expansion dispersal field, and areas within 50 feet.
 - 4. Location of cut banks, natural bluffs and sharp changes in slope within 50 feet of the primary and expansion field.
 - 5. Location of wells, springs, intercept drains, streams and other bodies of water on the property and within 150 feet of primary and expansion areas.
 - 6. Location of existing houses, structures, rock outcrops and large trees in the area of the test.
 - 7. Depth to groundwater when required, per Section 7.5.
 - 8. Special area standards.
 - 9. The person verifying the validity of the tests must describe the soils encountered in the profile holes as outlined in Section 7.4, as well as attest to the fact that required presoak was performed, that the test was set up in accordance with County standards, that he/she personally observed the site and a portion of the tests, and that it is a true and accurate indication of the suitability of the site for on-site sewage dispersal as measured by the standards of the Permit Authority and the County of Sonoma.

7.12 Cumulative Impact Assessment

- A. Criteria for Cumulative Impact Studies. A cumulative impact study shall be required for an individual OWTS system or a collection of OWTS systems that meet the following criteria:
1. Individual residential or non-residential OWTS systems:
 - i. where the maximum flow rate is greater than 1,500 gallons per day based on wastewater flows detailed in OWTS Manual Section 4.5 or OWTS Manual Table 11.1
 2. A collection of OWTS systems located on one parcel:
 - i. where adjacent system(s) is (are) within 50 feet and near adjacent system(s) is (are) within 100 feet of any part the system under permit or consideration; and,
 - ii. cumulative maximum flow rate of adjacent system(s) and near adjacent system(s) is greater than 1,500 gallons per day based on wastewater flows detailed in OWTS Manual Section 4.5.
 - iii. near adjacent system(s) need to be within 50 feet of an adjacent system to be included in the collection of OWTS systems.
 - iv. refer to Figure 7.12A Cumulative Impact Scenarios to assist in determining if a collection of OWTS systems is required to have a cumulative impact study.
- B. The study may be required for subdivisions, commercial, multifamily and individual proposed OWTS.
- C. The study shall be conducted by a qualified professional.
- D. The study shall include both the detailed methodology used and the principles of groundwater hydraulics.
- E. Groundwater Mounding Study shall be done to determine the highest extent the water table will rise during wet weather season.
- F. Nitrate Loading Study shall include the annual chemical-water mass balance.
- G. The cumulative study shall be conducted in accordance with the Final Report Assessment of Cumulative Impacts of Individual Waste Treatment and Disposal Systems; Ramlit Associates; February 1982 (aka Ramlit Study).
- H. The flow rate used for cumulative study shall be 100 gallons per bedroom per day for residential systems, design flow for multi-family, and design flow for non-residential systems.
- I. Collection of OWTS systems means the subject system, adjacent system(s) and near adjacent system(s).
- J. Subject system means any OWTS under an active septic permit application for a new system, a replacement system or to activate a reserve system.
- K. Reserve systems will not be included into the collection of OWTS systems under 7-12.A.2 unless the reserve system is actively receiving wastewater.
- L. Reserve systems will be a subject system when an application is received to utilize the reserve

system.

Figure 7-12A
Cumulative Impact Scenarios

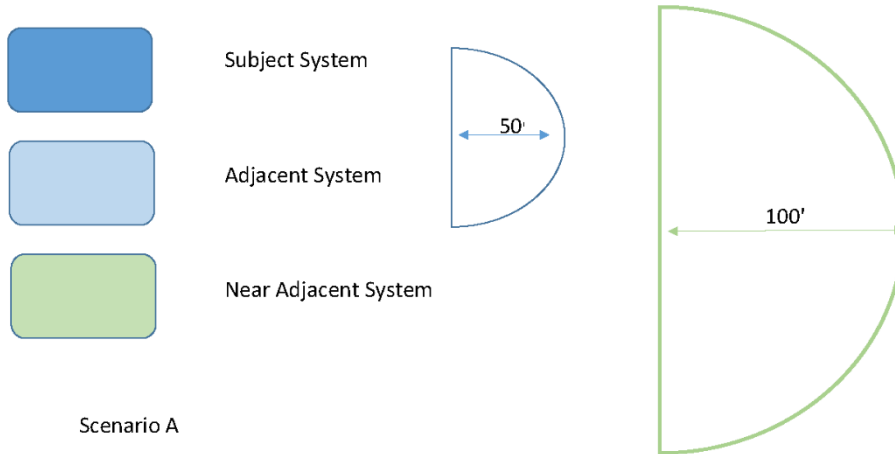

Scenario A

Study required if the flow rate of the four systems is greater than 1500 gpd.

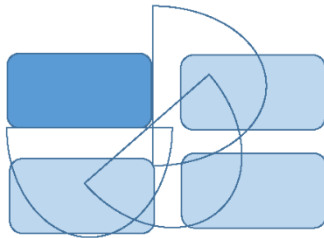

Scenario B

Study required if the flow rate of the three systems is greater than 1500 gpd.
The right most near adjacent system is not part of the collection of systems.

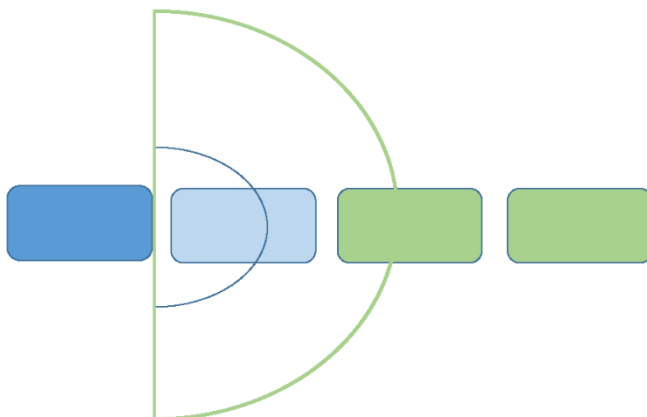

Scenario C -- Horizontal Arrangement

Study is required if the flow rate of the four systems is greater than 1500 gpd.

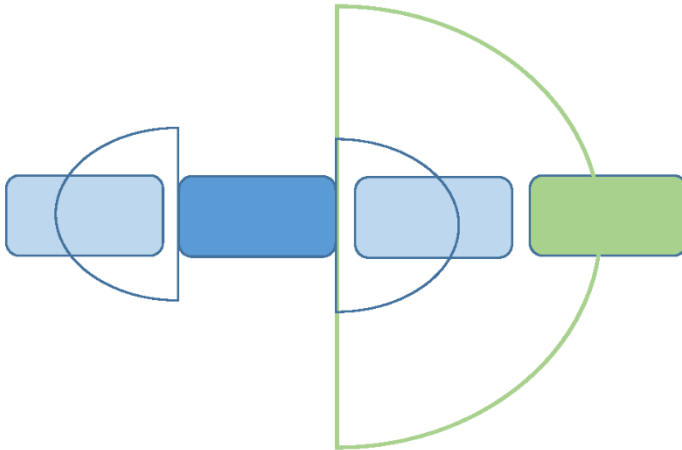

Scenario D -- Horizontal Arrangement

Study is required if the flow rates of the subject system and adjacent system is greater than 1500 gpd.

The near adjacent system is not included in the collection of systems because there is no adjacent system between the subject system and the neighboring system.

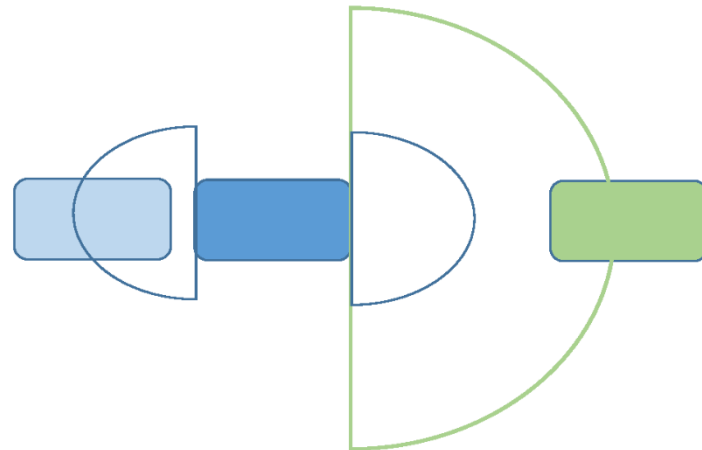

Scenario C -- Vertical Arrangement

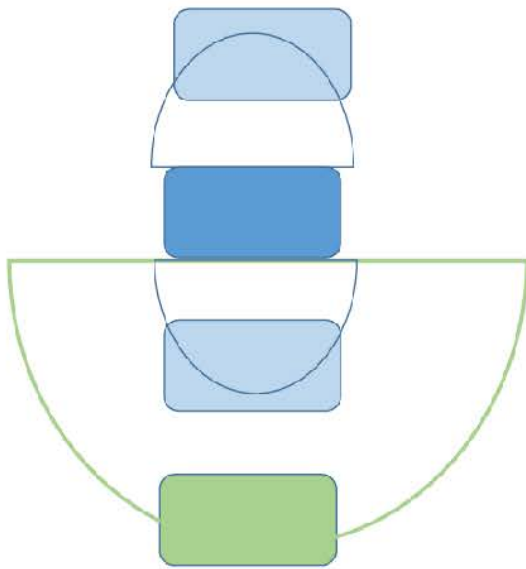

Scenario D -- Vertical Arrangement

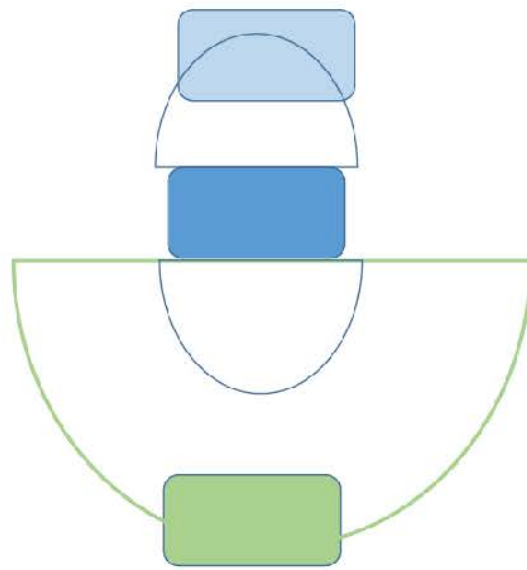

7-13 Location of Septic System Dispersal

- A. OWTS Location. Ninety percent of the OWTS dispersal area, primary and reserve(s), shall be within the site evaluation area.
- B. Process to define the site evaluation area.
 - 1. Locate the field test(s) on a site map;
 - 2. Draw a circle based on the radii specified in Table 7-13.
 - 3. Enclose the circle(s) with a square or box with straight lines that are at 90 degrees or parallel to each. The enclosed square, rectangle or box is the effective area for the given field evaluation.
 - 4. See Figure 7-13 as an illustration of this process.
- C. Each approved field evaluation shall have an effective radius as set out within Table 7-13.

**Table 7-13
Site Evaluation Radius**

| Site Evaluation | Radius (feet) |
|---------------------------|------------------|
| Soil Evaluation | 50 |
| Percolation Test | 25 |
| Groundwater Determination | 50 |

- D. This section does not reduce the minimum number of evaluation points required in other sections of this OWTS Manual.
- E. Non-suitable areas shall be avoided in the design using the radii associated with the type of field evaluation. Where overlapping areas occur between suitable areas and non-suitable areas, split the distance equally between the locations and redraw the circles and enclosed areas.

Figure 7-13
Site Evaluation Areas

Test Location(s): black circle / dot
 Radius: black line with arrow
 Circle: drawn with radius
 Area: box enclosing the circle(s)

Scenario 1:
One test location

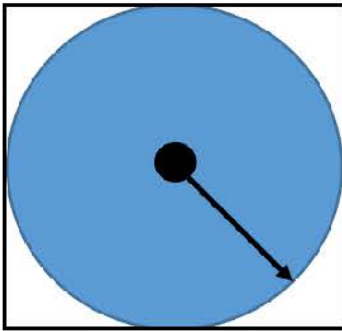

Scenario 2:
Three test locations

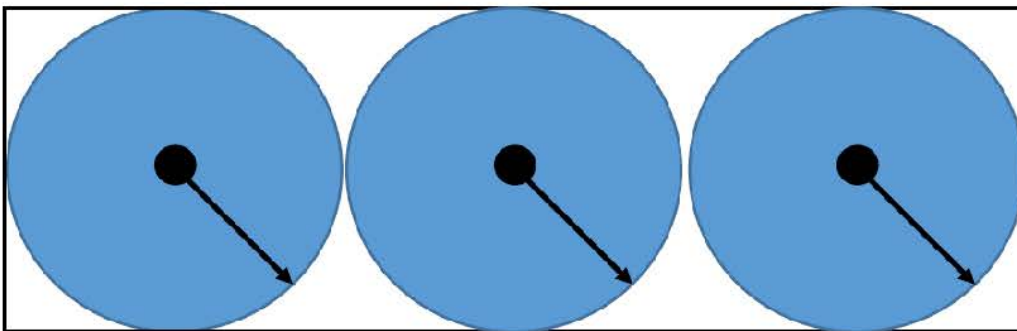

Scenario 3:
Three test locations

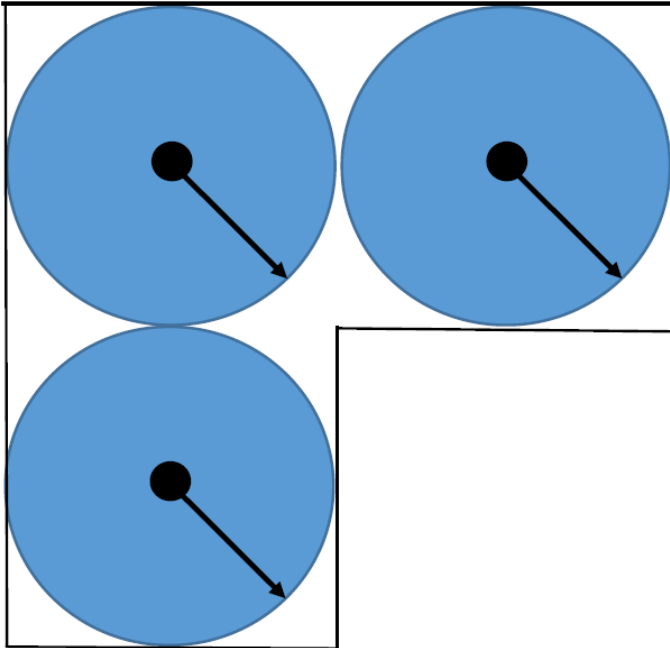

7-14 Prior Site Evaluation Work

A. The design of new, replacement, and repaired septic systems shall meet the current OWTS Manual requirements. Often, site evaluation work in support of an OWTS system design was done in the past. Site evaluation work that form the basis for a septic design cannot be vested but site evaluation work conducted in the past on a particular site may be acceptable to support a septic system design upon, under certain conditions.

The type of site evaluation work being discussed include:

1. soil profile evaluations (also known as pre-percs);
2. percolation tests; and,
3. groundwater table determination.

B. Past site evaluation work may be approved for use to support an OWTS system design that-meets OWTS Manual requirements:

1. If the site evaluation work was complete and the site does not appear to have changed in the time frame after the site work was completed. Complete site work means all parameters required at the time of the original site work were observed and documented. The site work must meet current standards and shall be verified in the field.
2. If the site evaluation work was incomplete, the options are:
 - a. to conduct supplemental site work;
 - b. to conduct new site work;
 - c. to create a design based on the most conservative soil application rate. The design shall be consistent with the current OWTS Manual.

Section 8 Criteria for OWTS Components

8.1 Septic Tank Requirements

- A. These requirements shall apply to all septic tanks in new OWTS and replacement systems.
1. Septic tanks shall be IAPMO approved. Septic tanks shall be sealed with an approved sealant so it is watertight. Wood septic tanks and metal septic tanks are prohibited.
 2. Septic tanks shall have at least two compartments separated by a baffle or equivalent arrangement. The inlet compartment shall have a capacity of not less than 2/3 the total volume.
 3. An inlet tee is required.
 4. Each compartment of the septic tank shall have access provided by a manhole having not less than 20 24 inches in minimum dimensions with a close fitting manhole cover.
 5. Each compartment of the septic tank shall have a riser extended from each manhole cover to the surface of the ground so as to facilitate inspection and maintenance of the septic tank. The riser shall be of equal size or larger than the manhole cover and shall be constructed of durable material. The manhole covers shall be close-fitting. All joints shall be properly sealed with a sealant and/or an interlocking mechanism approved by the Permit Authority.
 6. A corrosion-resistant, NSF rated effluent filter approved by the Permit Authority, capable of screening solids in excess of 3/16 of an inch in diameter, shall be provided.
 7. All connections from building to septic tank must conform to construction standards per the approved County Code requirements which includes the California Plumbing Code.
 - 8.

8.2 Septic Tank Sizing

- A. The minimum liquid capacity of any septic tank installed shall be 750 gallons. Septic tanks intended to serve single family dwellings shall be sized on the number of bedrooms in the dwelling. The septic tank size for commercial OWTS shall be based on the peak daily sewage flow formula of V (net volume in gallons) equals $1,125$ plus $0.75Q$ (daily wastewater flow in gallons).
- B. Minimum required septic tank sizing is shown in Table 8.2.

**Table 8.2
Septic Tank Capacity**

| Bedrooms | Tank Capacity (gallons) Pre-Cast Tank |
|---------------------|--|
| 1-2 | 750 |
| 3 | 1,000 |
| 4 | 1,200 |
| 5-6 | 1,500 |
| Additional Bedrooms | 250 per bedroom |

8.3 Septic Tank Watertight Test Requirements

- A. New and replacement septic tanks, pretreatment tanks and sump tanks shall be tested for water tightness.
- B. Plan submittals shall have language stating the requirement and procedure for watertight testing.
- C. A watertight test inspection shall be scheduled with the Permit Authority. The inspection results shall be recorded as a pass or fail by the Permit Authority.
- D. In the event of a failed watertight test, a re-test is allowable. A reinspection fee will be assessed prior to scheduling the retesting.
- E. The testing procedure:
 - 1. The tanks shall be installed properly, according to industry standard or manufacturers' requirements with the back fill placed around the tank(s) at a level below the invert of the inlet pipe and outlet pipe areas.
 - 2. Fill the septic tank, pretreatment tank, and/or sump tank with water up into the riser(s) two or more inches.
 - 3. The water level shall be marked at the beginning of the watertight test.
 - 4. The test duration shall be 30 minutes.
 - 5. A water level decline of 1/8 inch or more indicates a failed watertight test.

8.4 Sump & Pump System

- A. A pump system can be used to a supplement to an OWTS.
 - 1. In a standard system, a pump is utilized to pump effluent to a dispersal field The effluent at the higher elevation is then distributed to the dispersal field by gravity flow.
 - 2. In an alternative OWTS, a pump allows intermittent balanced dosing or pressurizing of effluent in the dispersal system. Any sump and pump must be designed, inspected and hydraulically tested for proper operation by the designer and Permit Authority staff prior to final approval of the installation.

8.5 Sump & Pump Requirements

- A. Sewage effluent sump and pump general requirements are as follows:
 - 1. Specifications for the sump and pump, including the pump performance curve, must be submitted with the design for the OWTS.
 - 2. Design information shall include the following:
 - a. Relative elevations of the pump and dispersal field pipe;
 - b. Total dynamic head loss through the effluent piping and valves;
 - c. Pump run times; and

- d. Design flow rate (gallons per minute).
3. All sump pump systems and distribution systems must be inspected and hydraulically tested for proper operation by the designer and Permit Authority staff prior to final approval of the installation and occupancy of the structure.
- 4.

B. Required features of the sump are as follows:

1. The minimum working capacity of all sumps is 300 gallons, including:
 - a. The design dose volume.
 - b. A minimum 200 gallon additional storage capacity between the high water alarm and inlet.
 - c. The minimum working capacity of sumps for non-standard OWTS is 500 gallons or three times the designed dose, whichever is greater.
 - d. Alternative configurations may be approved for systems utilizing pretreatment and repairs if justified by the designer.
2. Sump tanks shall be constructed of solid durable materials, which are not subject to excessive corrosion and degradation in the presence of domestic sewage and shall be watertight.
 - a. They shall meet the IAPMO construction standards for septic tanks of the said material (glass-fiber-reinforced polyester, polyethylene, synthetic fiber reinforced).
 - b. Wood and/or metal tanks are not allowed.
 - c. Concrete tanks shall be a monolithic casting or joints sealed with appropriate sealants.
 - i. Concrete tanks shall be made of sulfate-resisting cement, Specification C 150, Type II or highly sulfate-resisting cement, Specification C 150, Type V or coated with an asphalt emulsion or equivalent on the inside.
 - ii. The coated interior shall be allowed to dry for at least 24 hours.
 - iii. Asphalt emulsion or tar shall not be used as joint sealants.
3. All sumps shall have a riser that extends to at least two inches above the finished grade.
 - a. Risers shall be sealed watertight to the sump chamber with materials suited for the specific application.
 - b. Wood risers are not allowed.
 - c. Risers and lids in traffic areas shall be traffic rated and may be flush with the ground elevation.
4. All pipes and/or electrical conduits entering the sump tank or riser shall be sealed to make the passage gas and watertight.
 - a. If the pipes and/or electrical conduits enter a synthetic tank or plastic riser, rubber grommets

shall be used.

b. Non-shrink grouts should be used with concrete tanks or risers.

5. Sumps on downhill runs shall be placed within 30 feet of the leachfield, unless greater distances are allowed. When practical, sumps shall be located at a lower elevation than the leachfield.

a. The sump tank location must be accessible for a septic tank pumper to pump the tank.

6. A pre-screening device or filter capable of screening solids of a minimum of 3/16 inches size shall be installed in the septic tank or sump chamber to assist in preventing suspended solids from reaching the pump.

7. Wastewater shall exit the sump only through pump and pressure lines. Gravity overflows are prohibited.

C. Required features of the pump are as follows:

1. Float controls for the pump and audio/visual alarm shall be mounted to a Schedule 40 PVC pole, mounted inside a pump chamber, which can be removed for maintenance. See Figure 8.4a.

2. Control floats shall be attached to the PVC pole by plastic tie straps or plastic float collars.

a. Stainless steel straps will not be accepted.

3. The pump shall be mounted a minimum of 4 inches above the bottom of the sump chamber.

a. If applicable, non-corrosive materials shall be used to support the pump.

4. For the situations where a pump must be installed in the second chamber of the septic tank, the pump shall be placed in a screened pump vault within the second chamber.

a. Micro-dosing shall be required to minimize swings in the liquid level.

D. Required electrical features are as follows:

1. All materials, connections, and specifications shall meet the California Electric Code.

a. In all cases in which a sump with a pump is used for an OWTS, the contractor/owner shall obtain an electrical permit from Permit Authority or City Building Department having jurisdiction.

b. The Permit Authority or City Building Department shall be responsible for inspection and approval of all electrical code requirements.

c. Disconnecting means (control panel or disconnecting switch) shall be in visual sight of the pump location per the County adopted electrical code.

2. The alarm shall be equipped with:

a. A loud (87 decibels at a 10-foot minimum horizontal distance from the alarm location) audio alarm operated by a float switch or switches to indicate an "alarm" situation.

b. A minimum sized 7/8-inch diameter red light shall be mounted on the face of the panel, which shall glow as long as the "alarm" condition exists.

- b. Pump protection shall be provided by a thermal magnetic circuit breaker for overload protection.
 - i. If the pump is single-phase, the motor windings shall have internal thermal overload protection.
 - ii. If the pump is three-phase, the circuit protection in the alarm/control box shall be equipped with an adjustable thermal overload protection.
 5. Below grade electrical splices shall be placed in a Sonoma County approved pull box installation or a Sonoma County approved external splice box with waterproof splice connectors.
 - a. Traffic-rated pull boxes shall be used in traffic and adjacent areas. See Figure 8.4b.
 6. Electrical non-metallic splice boxes may be placed within the sump chamber for existing sump/pump systems that were installed prior to this requirement. They shall be gas-tight boxes with waterproof splice connectors.
 7. The pump power lead and the float switch control wires may run in a common conduit. High voltage and low voltage conductors shall be run in separate conduits.
 - a. All cords going into the sump shall be individually sealed with non-metallic gas tight fittings in either the riser, junction box or alarm/control panel as appropriate.
 - b. Metallic gas tight fittings are not allowed.
 - c. All exposed PVC conduit shall be Schedule 80.
 8. The control panel and its contents shall be UL listed.
 - a. The control panel shall be placed in an easily accessible location.
 - b. A non-resettable dose counter shall be installed in control boxes utilized for non-standard OWTS.
 - c. If a dose counter is not provided, a non-resettable flow meter shall be provided on the outgoing line to the dispersal field. Additionally, systems with flush modes shall be equipped with a flow meter on the return line. The flow meter shall read in gallons per minute and total gallons.
 - d. The control panel shall be equipped so settings can be adjusted manually on-site.
 - e. The control box shall be labeled "Caution - Electrical Hazard."
 - f. The dose settings (time or gallons), calculated dose volume and float settings shall be posted on the inside of the panel.
 9. All exterior mounted alarm and controller enclosure shall be NEMA Type 4. If the alarm/controller is mounted more than 75 feet from any residence or commercial structure served by the system, a separate audible/visible alarm shall be provided at the primary structure connected to the OWTS.
 - a. If mounted indoors, the enclosure for the remote and audio/visual alarm shall be NEMA Type 1.
- E. Required features of sewage piping are as follows:

1. The effluent line entering the sump shall be minimum of three-inch diameter, ABS Schedule 40 or PVC Schedule 40, and shall be sealed with a coupling integrally cast into the tank, a properly fit neoprene grommetor with non-shrink grout as appropriate.
 - a. The effluent line shall be turned down with a sanitary tee fitting and drop that extends to within four inches of the tank floor.
2. Minimum one inch PVC Schedule 40 from pump to dispersal field is required with:
 - a. A 1/8-inch diameter anti-siphon and air vent hole located between the pump and check valve angled down and away from the floats;
 - b. PVC check valve;
 - c. PVC gate or ball valve and union(s).
3. Brass type fittings, valves, and piping are prohibited in sump chambers.
4. High points in the transmission line after the sump may require an “air relief valve” depending on the design situation.

Figure 8.4b Sump and Pump Requirements

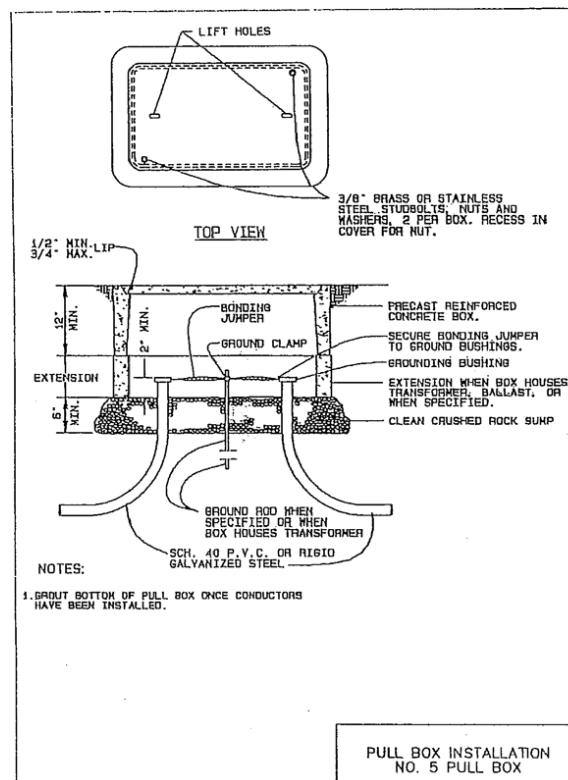
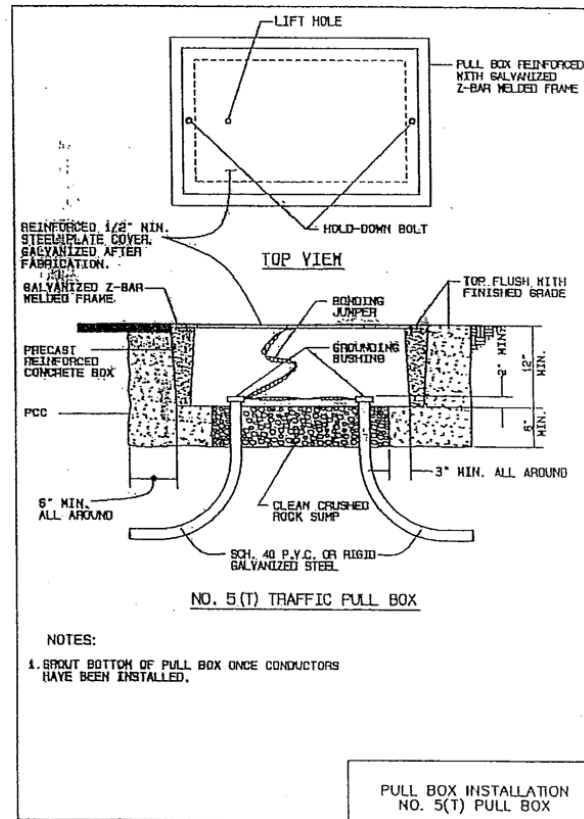

8.6 Alternating Leachfields

- A. Alternating leachfields are required for OWTS of greater than 500 lineal feet of leach line.
- B. An approved diversion valve, or dosing tank with pump(s), is required for alternating leachfields.
- C. Each primary field shall be equal to a minimum of 75 percent of the primary leachfield lineal requirement.
- D. For installations of from 500 to 1,000 lineal feet of leach line, the dosing requirement may be satisfied by any one of the following approaches:
 - 1. Dosing tank with a pump which discharges the tank on timed dose or on demand at a minimum of once every three to four hours.
 - 2. Alternating leachfields with an approved diversion valve.
 - 3. Two or more septic tank/leachfield systems, with neither system exceeding 500 lineal feet of leach line.
- E. For installations of greater than 1,000 lineal feet of leach line, the dosing requirement may be satisfied by any of the following approaches:
 - 1. Dosing tank with two pumps dosing alternately and each serving $\frac{1}{2}$ of the leachfield.
 - 2. Three or more septic tank/leachfield systems, with no system exceeding 500 lineal feet.

8.7 Intercept Drains

- A. Design of the intercept drain is dependent on the size of the contributing drainage area, the amount of water that must be removed, the soil's hydraulic properties, and the available slope of the site. The use of intercept drains to lower the level of perched groundwater in the immediate dispersal field area shall meet the following conditions:
 - 1. The design plan shall be signed and stamped by a Qualified Consultant.
 - 2. Natural ground slope is greater than ~~5~~ five percent.
 - 3. Site investigations indicate groundwater to be perched.
 - 4. The intercept drain extends from ground surface to a minimum of six inches into the geologic feature (aquitar) creating the perched water table.
 - 5. A trench minimum width of one foot.
 - 6. The upslope side of the trench shall be lined with a geotextile filter fabric. The geotextile filter fabric may be eliminated with the use of class two permeable material.
 - 7. The down slope side of the trench and the trench bottom shall be lined with 10 to 12 thousands of an inch polyethylene sheeting.
 - 8. The drain rock shall be $\frac{3}{4}$ to two inch diameter in size and washed, contain less than one percent fines (sand, very fine silt, and clay) or class two permeable material. Aggregate shall extend from trench bottom to within six to 12 inches of grade and backfilled to grade with native soil.
 - 9. The collection pipe shall consist of 4 four-inch diameter rigid, perforated drain pipe, oriented

with holes down and installed on top of the drain rock, approximately two to four inches above trench bottom.

10. The outlet pipe shall consist of a minimum four-inch diameter rigid, solid (non-perforated) drain pipe at the point of discharge with placement of rip rap and be maintained free and clear.
 11. The trench bottom and pipe shall be sloped for gravity flow at a minimum one percent gradient throughout the trench and extending to the outlet point.
 12. Cleanouts to grade are required
 - a. At the upslope end of the drain;
 - b. At bends of 45 degrees or greater;
 - c. At least every 100 feet along the length of the drain.
- B. Where all of the above conditions cannot be met, actual performance of the intercept drain shall be demonstrated prior to approval for an OWTS permit.
- C. Intercept drains are required and shall be installed pursuant to Section 18 Variance Prohibition and Special Standards Areas, West Petaluma Area.
- D. All portions of the intercept drain shall be five feet minimum from property lines.

Figure 8.7
Typical Interceptor Drain

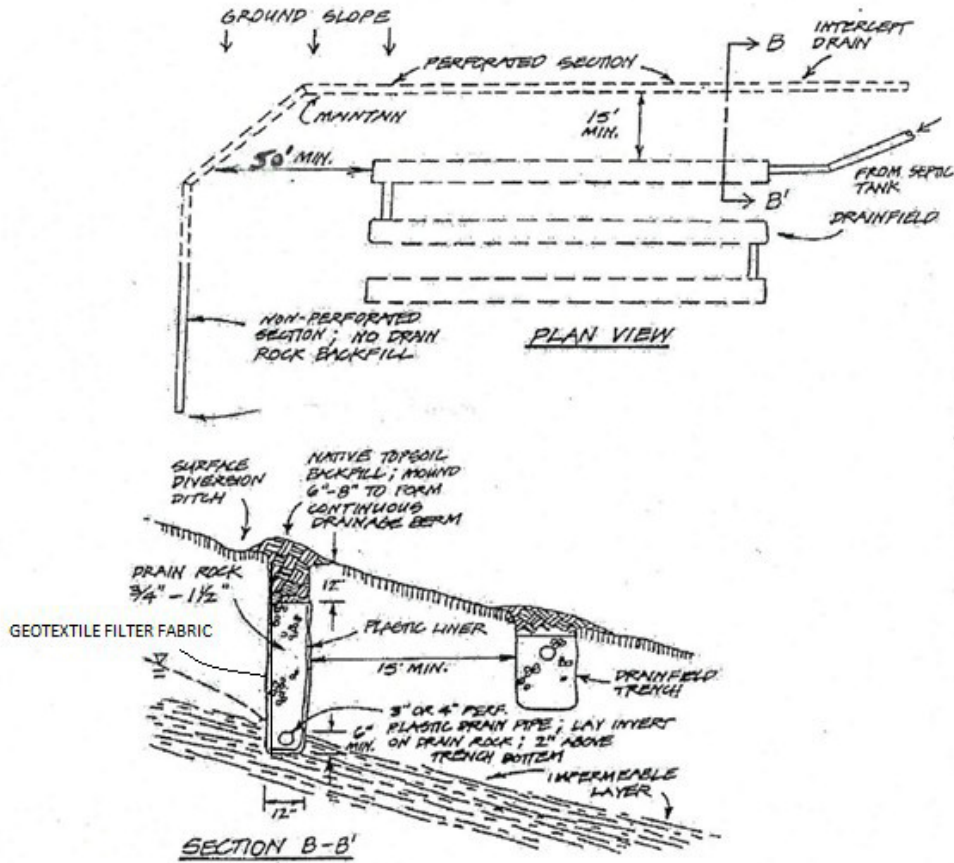

8.8 Stream and Driveway Crossings

- A. All pipe used within the watercourse setbacks or under a driveway must be PVC Schedule 40 or other approved material.
- B. All effluent transmission pipes used for stream crossings must be pressure tested at the time of installation and prior to final inspection. Pressure testing shall be conducted in accordance with the most current version of the Sonoma County Water System Standards, Section 8, Inspection and Testing (including record drawings).
 - 1. For crossings below the stream bed, the buried pipe must have a minimum of four feet of cover over the portion of the pipe under the centerline of the stream.
 - a. This may be reduced to one foot if the portion of the pipe under the stream banks is encased (sleeved) in ABS Schedule 40, PVC, cast iron, or concrete pipe extending a minimum of 25 feet beyond the high water elevation mark on both sides of the stream.
 - 2. For crossings above the stream, the pipe must be encased (sleeved) with cast iron or solid well casing whenever it is exposed or above the stream.
 - a. Pipe must be one foot above the 100 year flood elevation.
 - b. Pipe must be either covered with fill over a culvert or hung by approved hangers every four feet from an appropriate supporting structure as specified in the California Plumbing Code.
- C. All effluent transmission pipes used for driveway crossings must have a minimum of one foot of native cover over the pipe and encased (sleeved) with ABS Schedule 40, PVC, cast iron, or concrete pipe extending a minimum of 5 feet beyond the driveway edges.

Section 9 Criteria for Standard OWTS

9.1 Standard OWTS

- A. A standard OWTS consists of an approved septic tank and standard dispersal trenches. A standard OWTS may include a pump system to enable the installation of a dispersal field up-slope of the structure to be served.
- B. Standard OWTS may be allowed in areas with a soil percolation rate of one to 60 minutes per inch at trench bottom.
- C. The minimum soil depth below the leaching trench shall be three feet for a Standard OWTS. The soil below the trench shall have soil percolation rates between one to 120 minutes per inch.
- D. Sizing of standard OWTS shall be based on Table 7.2a Sewage Application/Soil Loading Rates (gallons per square foot per day) at 120 gallons per bedroom. Lineal footage sizing requirement is based on the consideration of sidewall area only. Credit is not given for trench bottom area.
- E. The required lineal feet of standard leach line is determined by the Design Flow Rate divided by the Soil Loading Rate (Table 7.2a) divided by the trench lineal area available (sidewall infiltration only, bottom area is not included). For example, a 2 two-bedroom house at 120 gallons per day per bedroom equals 240 gallons per day. A percolation rate of 30 minutes per inch equals 0.56 gallons per square foot per day. 12 inches of gravel below the pipe times 2 two equals 24 square feet per linear foot. Thus 240 divided by 0.56 divided by 24 equals 214 linear feet required. See Table 9-1 for example linear feet of leach line based on assumed effluent quality, flow rate, hydraulic loading rate and absorption area.

**Table 9.1
Illustrative Table for Linear Footage of Leach Line per Number of Bedrooms for a
Standard Septic System**

| Texture | Structure Shape | Structure Grade | Hydraulic Loading (gallons/square foot/day) | Leach Line Length (feet) 1 Bedroom | Leach Line Length (feet) 2 Bedroom | Leach Line Length (feet) 3 Bedroom | Leach Line Length (feet) 4 Bedroom |
|---|-----------------------------|-------------------------------------|---|------------------------------------|------------------------------------|------------------------------------|------------------------------------|
| Coarse sand, sand, loamy coarse sand | Single grain | Structureless | 1.2 | 50 | 100 | 150 | 200 |
| Fine sand, loamy fine sand | Single grain | Structureless | 0.6 | 100 | 200 | 300 | 400 |
| Sandy loam, loamy sand | Massive Platy | Structureless | 0.35 | 171 | 343 | 514 | 686 |
| Sandy loam, loamy sand | Massive Platy | Weak | 0.35 | 171 | 343 | 514 | 686 |
| Sandy loam, loamy sand | Prismatic, blocky, granular | Weak | 0.5 | 120 | 240 | 360 | 480 |
| Sandy loam, loamy sand | Prismatic, blocky, granular | Moderate, strong | .8 | 75 | 150 | 225 | 300 |
| Loam, silt loam, sandy clay loam, fine sandy loam | Massive platy | Structureless Weak | - | - | - | - | - |
| Loam, silt loam, sandy clay loam, fine sandy loam | Prismatic, blocky, granular | Weak, moderate | .5 | 120 | 240 | 360 | 480 |
| Loam, silt loam, sandy clay loam, fine sandy loam | Prismatic, blocky, granular | Strong | .8 | 75 | 150 | 225 | 300 |
| Sandy clay, silty clay loam, clay loam | Massive Platy | Structureless weak, moderate strong | - | - | - | - | - |
| Sandy clay, silty clay loam, clay loam | Prismatic, blocky, granular | Weak, moderate | .35 | 171 | 343 | 514 | 686 |
| Sandy clay, silty clay loam, clay loam | Prismatic, blocky | Strong | .6 | 100 | 200 | 300 | 400 |
| Clay, silty clay | Massive Platy | Structureless weak, moderate strong | - | - | - | - | - |
| Clay, silty clay | Prismatic, blocky, granular | Weak | - | - | - | - | - |
| Clay, silty clay | Prismatic, blocky, granular | Moderate, strong | .2 | 300 | 600 | 900 | 1,200 |

Assumptions:

Hydraulic Loading Rate assumes Septic Tank Effluent

Flow Rate per Bedroom = 120 gallons per day per bedroom

Absorption Area per Length = 2 square feet / linear foot

Trench Length = no. Bedrooms times Bedroom Flow Rate / (Hydraulic Loading times Absorption Area per Length)

9.2 Standard Dispersal Trench

- A. Dispersal trenches shall be installed on contour.
- B. Dispersal trenches shall be placed a minimum of eight feet on center regardless of the depth of drain rock.
- C. The depth of the dispersal trenches, dependent on the slope, percolation depth, or type of standard OWTS is found in Table 7.7.
- D. The dispersal trenches shall be constructed in maximum lengths of 100 feet and at widths between 18 and 24 inches. The bottom of the dispersal trench and the dispersal pipe shall be level to within a tolerance of three inches in 100 feet.
- E. The side walls of the trenches shall be scarified/roughened so there is no soil smear prior to backfill.
- F. Dispersal trenches shall contain double-washed rock filter material of ~~3/4~~ three quarter inch to two and one half inches in diameter, perforated sewage distribution pipe, geotextile filter fabric or untreated building paper, and back-filled with a minimum of 12 inches of soil.
- G. The Permit Authority may permit gravel-less trench construction. The design, manufacturing and materials shall be durable and approved by the Permit Authority (See Section 9.4).
- H. A concrete or plastic distribution box shall precede each dispersal trench for the receipt and distribution of wastewater into the trenches. There shall be a minimum distance of four feet between the distribution box and the dispersal trench.
- I. Distribution boxes shall be placed for serial distribution of wastewater on sloping ground.
- J. Distribution boxes shall be placed for equal distribution of wastewater on flat terrain.
- K. The distribution box shall be placed in native soils at the appropriate depth. A minimum of 12 inches of backfill shall be placed above the distribution box or extended to grade with a riser. The distribution box shall not be placed in over-excavated soils.
- L. Metal detection markings, a two foot by one half inch galvanized pipe or rebar shall be installed flush and vertical at each distribution box and in a vertical position against the trench wall at the end of the leach line, and also in the middle of lines that are longer than 50 feet. The pipe or rebar shall not be placed at a depth greater than 24 inches. Refer to Figure 9.2 Standard dispersal trench detail.
- M. The distal end of each sewage distribution pipe/leach line pipe shall be capped.

**Figure 9.2
Standard Dispersal Line
Trench Example**

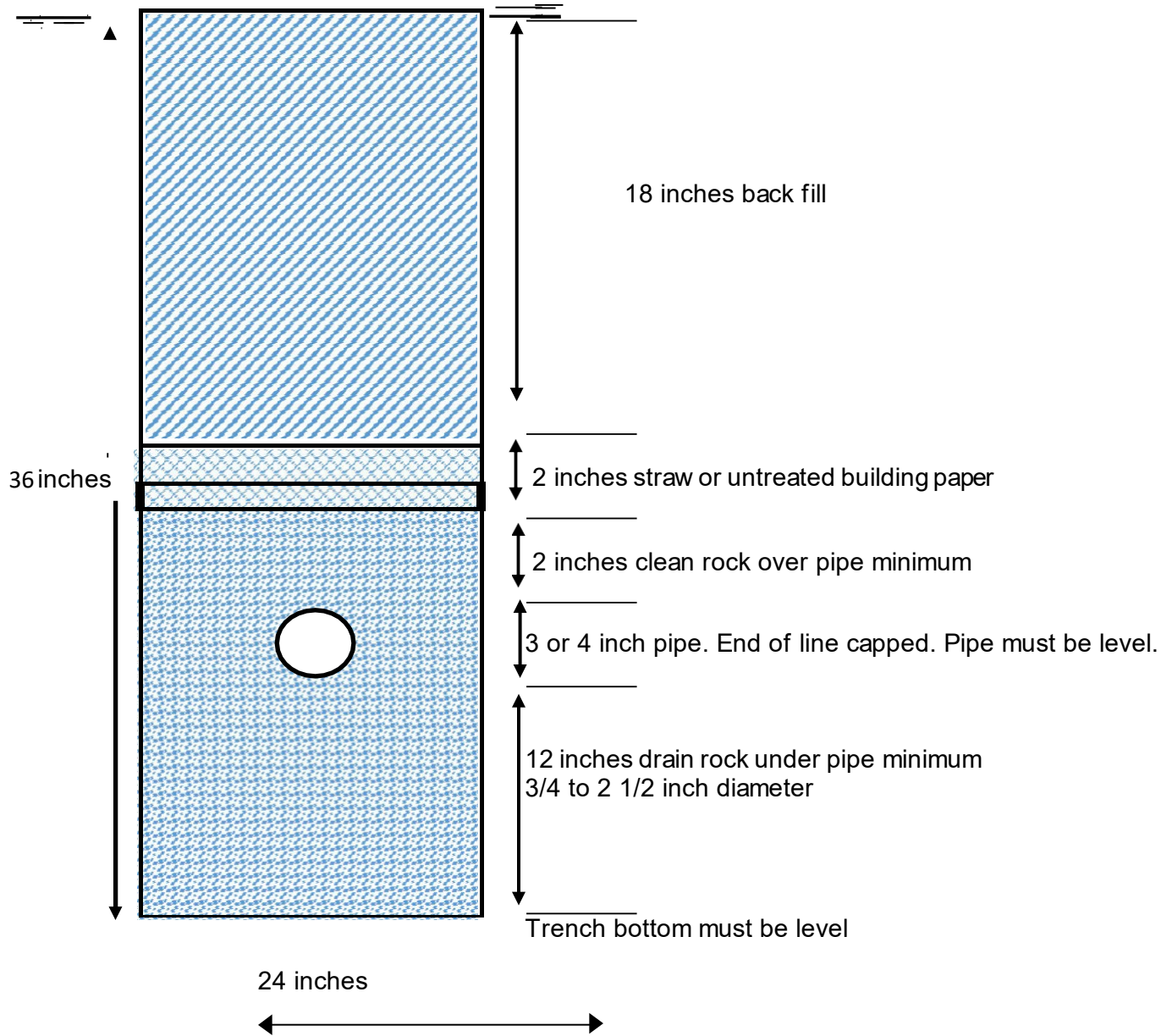

9.3 Seepage Pits

- A. Seepage Pits may be allowed under the following conditions:
1. Separation of the bottom of seepage pits to groundwater shall not be less than 10 feet.
 2. Seepage pits shall be no deeper than 6 feet.
 3. Seepage pits can only be installed if a satisfactory dispersal trench installation cannot be installed.
 4. It is recommended that seepage pits be at least the same volume, prior to filling with gravel or sand, as the septic tank that would be required based upon the number of bedrooms in the dwelling.
 5. All seepage pits shall be completely filled with clean drain rock. No redwood seepage boxes will be permitted.

9.4 Gravel-less Drain Field Systems

- A. Gravel-less drain field systems are similar to standard dispersal trench systems except that “chambers” or “bundles” are used in the trench instead of conventional rock and pipe.

Percolation rates for a standard OWTS apply to Gravel-less Drain Field Systems. Proof of soil below the bottom of the trench is the same as for standard systems and can be demonstrated by percolation testing, soil morphology, and texture analysis. At a minimum, three feet of continuous acceptable soil is required below the proposed trench bottom.

Applicability: Areas with limited access to transport rock.

- B. Gravel-less chambers are typically made of recycled plastic and must be pre-approved by the Permit Authority.
1. Chambers are usually installed in an 18 or 24-inch wide trench.
 2. The chambers are interlocking arches that form a continuous drainage area with louvers to allow dispersal of the effluent into the soil.
 3. Sizing of the OWTS dispersal field is based on the height of the louvers sidewall infiltration area only. No credit is given for the trench bottom area. For example, if the chambers have louvers to a height of 9.5 inches, an infiltrative area of 1.6 square feet per linear foot is available.
 - a. Any other configuration must be reviewed on a case by case basis.
- C. Cylindrical bundles typically consist of a geosynthetic aggregate held in place with a high density polyethylene netting, with or without a 4-inch polyethylene pipe, and must be pre-approved by the Permit Authority.
1. Bundles are usually installed in an 18 or 24-inch wide trench.
 2. The bundles, also referred to as cylinders, are typically 12 or 18 inches in diameter.
 3. Sizing of the OWTS dispersal field is based on the sidewall area beneath the invert, the number and the configuration of the bundles placed in the trench. No credit is given for the trench bottom area. For example, a bundle with a diameter of 12 inches containing the pipe, installed in a square configuration

with 3 additional bundles without pipe, installed in a 24-inch trench, provide an infiltrative area of 3.0 square feet per linear foot.

- a. Any other configuration must be reviewed on a case by case basis.
- D. Where soil and site conditions allow, approved chamber and cylindrical bundle systems may be installed in lieu of conventional gravel trench at depths up to 60 inches, as measured from the base of the trench to ground surface.
- E. Minimum 12 inches of soil cover is required over the cylindrical bundle(s) or chambers.
- F. Trench spacing, prevention of soil infiltration from cover soil, and all other requirements are the same as for gravel trenches.
- G. The chamber and cylindrical bundle systems are not to be installed in locations that would be subject to vehicular traffic, such as driveways or parking areas.

9.5 Filled Land Systems

- A. Filled Land OWTS utilize onsite or imported fill to supplement and create the required soil cover in the dispersal area.
 - 1. Filled Land proposals for subdivisions which received tentative map approval based on the ~~prior~~ filled land septic system policy dated January 1, 2009, shall be re-evaluated under current Filled Land or alternate OWTS criteria.
 - 2. Filled Land OWTS shall meet standard system siting and sizing criteria, except for the fill depth.

**Table 9.5
Filled Land OWTS Trench Depth and Fill Requirements**

| Row | A Trench Depth | B Gravel Depth Below Pipe | C Pipe and Gravel Above Pipe (3" for each) | D Trench Backfill | E Cover Fill Depth Above Native | F Total Fill Depth |
|-----|----------------------|---------------------------------|---|-------------------------|---------------------------------------|--------------------------|
| 1 | 15 | 12 | 6 | -3 | 15 | 15 |
| 2 | 18 | 12 | 6 | 0 | 12 | 12 |
| 3 | 18 | 15 | 6 | -3 | 15 | 15 |
| 4 | 21 | 18 | 6 | -3 | 15 | 15 |
| 5 | 21 | 12 | 6 | 3 | 9 | 12 |
| 6 | 24 | 21 | 6 | -3 | 15 | 15 |
| 7 | 24 | 18 | 6 | 0 | 12 | 12 |
| 8 | 24 | 12 | 6 | 6 | 6 | 12 |
| 9 | 27 | 24 | 6 | -3 | 15 | 15 |
| 10 | 27 | 18 | 6 | 3 | 9 | 12 |
| 11 | 27 | 12 | 6 | 9 | 3 | 12 |
| 12 | 30 | 24 | 6 | 0 | 12 | 12 |
| 13 | 30 | 18 | 6 | 6 | 6 | 12 |

| | | | | | | |
|--|----|----|---|----|----------------------------|----|
| 14 | 30 | 12 | 6 | 12 | No Fill Standard System | 12 |
| Column D – trench backfill (relative to native grade) is the trench depth minus gravel depth minus pipe diameter minus gravel over pipe; (if less than zero, gravel extends above grade and into cover fill) | | | | | | |
| Column E – equals 12 inches minus column E (12 inches over the top of gravel) | | | | | | |
| Column F – Total Fill Depth equals the trench backfill (Column D) plus the cover fill depth above native (Column E). | | | | | | |

3. A full description of the complete installation including quality, kind and grade of all materials, equipment, construction workmanship and methods of assembly and installation shall be provided.
4. Proof of soil below the bottom of the trench is the same as for standard systems and can be demonstrated by percolation testing, soil morphology, and texture analysis. At a minimum, three feet of continuous acceptable soil is required below the proposed trench bottom. A minimum of two feet of continuous acceptable soil is required with the use of a pretreatment system.
5. Filled Land Systems are limited to areas not exceeding 25 percent slope.
6. All dispersal trenches shall be a minimum of 12 inches in depth into native soil.
7. The distribution pipe shall be covered with two to three inches of drain rock and 12" of soil (native plus import).
8. Gravel depth below pipe a minimum of 12 inches unless a variance is approved. See Table 9.6 for permissible gravel depth below pipe.
9. Trench width of 18 to 24 inches.
10. Increased trench depth and gravel depth is permissible with a subsequent reduction of fill soil.
11. A minimum of 12 inches of soil is always required above the gravel over the pipe. See Table 9.6 for fill material requirements.
12. The absorptive quality of imported soil for the leachfield cover shall be equal to or better than the native soil. Sand, gravel, rock or compost does not qualify as acceptable cover material for filled land systems.
13. Cover material for filled land systems shall be constructed in not more than eight-inch layers to approximately the same relative compaction as the upper soil horizon native to the site. Certified results of the soil density test may be required to be submitted to the Permit Authority Well and Septic Section by the RCE or REHS.
14. The fill is to be of uniform depth extending to a distance of at least five feet from the center and ends of any trench, plus two feet beyond the distribution box, with additional fill to create a five to one taper past the uniform fill.
15. Fill material is not required to be placed on the reserve replacement area prior to permitting of the replacement system.
16. Site specifications for fill shall indicate that vegetation is to be removed and surface prepared to permit good mixing of the native soil and fill material added.

- a. Areas with closely spaced trees more than 24 inches in diameter are generally not suitable for filled-land systems.
 - b. Rototilling to prepare the site for fill is prohibited.
 - c. A single pass six-inch rip of the surface soil to ensure a good mixing of the native soil and the fill material is required. Ripping shall be parallel to the topographic contours.
 - d. Wheeled tractors are to be minimized in the dispersal area at this time to avoid soil compaction.
17. Specifications on Filled Land proposals require the fill to be completed before any leaching trenches are constructed.

9.6 Shallow Sloping OWTS

- A. A shallow sloping OWTS is a standard OWTS where the soil below the trenches is inadequate soil for treatment. The system is placed on slopes from 12 ½ to 30 percent and has trench depths of 36 inch minimum. As this system type achieves treatment horizontally it is critical to prevent effluent from surfacing downslope or “breaking out.” To prevent “break out” the trench bottom needs to be at least 15 feet from the hillside as drawn with a horizontal line.

Applicability: Areas of shallow soil.

- B. Site suitability considerations include:

1. Poor soils at trench bottom and the trench bottom being 15 feet horizontally from the slope surface. One or more poor soil locations documented through a soils evaluation.
2. Eight or more percolation test holes (in no instance less than 36 inches in depth) are required:
 - a. at least six in the primary/replacement area;
 - b. One hole 25 feet downslope; and
 - c. One hole 50 feet downslope of the lowest leach line in the primary/replacement area.
3. Percolation rates of one to 60 minutes per inch are required.
4. Percolation rates of faster than five minutes per inch may require additional evidence that breakout of effluent to the surface or contamination of beneficial waters will not occur.
5. The percolation test report must evaluate slope stability. Proposed leachfield areas which are identified on geologic maps of Sonoma County as unstable or questionable must be surveyed by a Registered Geologist. Any mitigations recommended by the geologist are to be incorporated into the system design.
6. Any proposed leachfield area with outcroppings of bedrock or impermeable soil horizons is not acceptable for a “shallow sloping system.”

- C. The design criteria for a “shallow sloping OWTS” includes the following:

1. Shallow sloping OWTS are allowed for residential applications only. Non-residential designs will be based on Permit Authority, EPA, or other approved design criteria.

2. Proof of soil below the bottom of the trench is the same as for standard systems and can be demonstrated by percolation testing, soil morphology, and texture analysis. At a minimum, three feet of continuous acceptable soil is required below the proposed trench bottom.
 3. Dispersal fields are to be set back a minimum of 50 feet from any bank, natural or manmade, unless otherwise specified by Table 7.2c or where more stringent requirements may apply.
 4. Leachfields and reserve replacement areas shall be placed to utilize as much of the upper contours of the site as possible. Serial distribution is required unless an approved parallel distribution system is developed.
 5. Trenches must be at least 18 inches wide and a minimum of 36 inches deep. Construct dispersal trenches with 12 inches of gravel under the pipe, 2 inches of gravel over the pipe, and 18 inches of earth backfill. If there is more than 36 inches of soil as shown by percolation tests and more than 12 inches of gravel can be used, credit for use of additional trench sidewall may be granted.
 6. Space trenches at least 10 feet on center (eight feet solid earth between trench walls).
 7. Amount of leaching trench required for each primary field will be determined from the number of bedrooms and approved percolation rate.
 - i. Construct two primary leachfields divided by an approved diversion valve which can be alternated on at least a yearly basis.
 - ii. Each primary field shall be equal to 100 percent of the pre-determined lineal requirement.
 - iii. Provide an accessible enclosure for the diversion valve.
 8. All dispersal fields are to be provided with an intercept drain unless no significant watershed exists above the system.
 - i. Exceptions must be justified by satisfactory wet-weather groundwater determinations.
 - ii. Intercept drains shall be installed according to Section 8.6.
 - iii. Drainage diversions shall not influence neighboring properties.
 - iv. All surface drainage shall be diverted away from the leachfield area.
- D. The following additional requirements apply to “shallow sloping OWTS”:
1. Benching is not permitted during construction of the dispersal field.
 2. The area of the leachfield should be stabilized by seeding with native grasses to control erosion.
 3. No animals may be contained, housed, or pastured over the dispersal field. The soil in the dispersal field area shall not be disturbed by cultivation or tilling.
 4. If any lot is to be created utilizing a “shallow sloping system” design, appropriate deed restrictions shall be recorded prior to validation of the land division.

9.7 Pressure Distribution (PD) OWTS

- A. A Pressure Distribution (PD) OWTS uses a pump to provide uniform dosing of effluent through pressurized small diameter perforated pipes in the leaching trenches. This system can be either a standard system or a non-standard system.
- B. The Standard PD has the same soil, groundwater separation and percolation rate requirements as a standard trench dispersal system, whereas the Non-Standard PD system allows for a shallower depth of soil and shallower depth to groundwater mitigated with supplemental treatment and a wider range of percolation rates. The Non-Standard PD is typically used where there is shallower topsoil over slowly permeable or fractured subsoils.
- C. The minimum requirements for a Standard PD are as follows:
1. Percolation rates between one to 60 minutes per inch at the sidewall at bottom of the trench;
 2. Percolation rates between one to 120 minutes per inch below trench bottom;
 3. For soil with greater than 15% silt and clay, a minimum of 36 inches of suitable soil beneath the proposed trench bottom and a minimum of 36 inches of separation to groundwater;
 4. For soil with less than 15% silt and clay, a minimum of 60 inches of suitable soil beneath the proposed trench bottom and a minimum of 60 inches of separation to groundwater;
 5. Gravel size of $\frac{3}{4}$ inch to two and a half inches.
- D. The minimum requirements for a Non-Standard PD OWTS are as follows:
1. A supplemental treatment unit incorporating into the system design;
 2. Percolation rate of one to 120 minutes per inch at the sidewall at the bottom of the trench and below the trench;
 3. Percolation rate of one to 120 minutes per inch below trench bottom;
 4. Rates faster than one minute per inch are not acceptable;
 5. A minimum of 24 inches of suitable soil beneath the proposed trench bottom;
 6. A minimum of 24 inches of separation to groundwater from trench bottom;
 7. Percolation rates shall be measured at the following depths from native grade relative to slope percent as follows:
 - a. 24 inches minimum on slopes up to 20 percent.
 - b. 30 inches minimum on slopes up to 25 percent.
 - c. 36 inches minimum on slopes up to 30 percent.
 - d. 60 inches maximum on slopes up to 30 percent.
- E. General design criteria for both PD OWTS include the following:

1. The minimum of depth of soil below trench bottom of permeable soil shall extend a horizontal distance of no less than 25 feet down gradient from the edge of the last proposed trench.
2. Soil structure and texture above the trench is extremely important to maximize system function. As such PD systems may not be installed below non-permeable type soils such as high shrink well clays, highly compacted soils, highly cemented soils, and/or massive or platy soil structures, without the addition of an approved supplemental unit.
3. Minimum trench spacing:
 - a. On slopes 20 percent or less, the minimum trench spacing shall be six feet, center to center.
 - b. On slopes greater than 20 percent and up to 30 percent, the minimum trench spacing shall be seven feet, center to center.
 - c. The minimum trench spacing, center to center, shall be increased by one foot horizontally for each $\frac{1}{2}$ foot increase in gravel depth vertically.
4. Distribution trenches shall follow the natural contour of the ground; trench bottoms shall be level.
 - a. The maximum deviation along the downhill side of the trench shall not vary more than three inches vertically per 100 feet horizontally. Distribution trenches shall be angled or curved to meet this requirement. The distribution field should not be placed on concave land forms.
5. Approved distribution trench design.
 - a. The maximum trench depth shall be 60 inches.
 - b. Distribution piping shall be Schedule 40 PVC or greater of at least $\frac{3}{4}$ inch diameter.
 - c. The aggregate below the pipe shall be $\frac{3}{8}$ to $\frac{3}{4}$ inch double washed gravel with less than one percent fines passing the 200 sieve.
 - d. Two inches of aggregate is required over the perforated sections of the pressurized distribution lateral.
 - e. The minimum requirement of backfill is 12 inches over the pipe.
 - f. The quality of the back fill shall be consistent with the site's native topsoil in terms of structure and texture.
6. Absorption Area Shall be calculated as the sidewall beneath the distribution pipe. The bottom area of the trench is not included as absorption area for sizing purposes.
7. Designers shall calculate the total dynamic head loss of the entire distribution system taking into account:
 - a. Vertical differences.
 - b. Length of entire piping system.
 - c. Loss of all valves, tees, elbows, and appurtenances.

- d. Head loss shall be referenced as feet of elevation.
 - e. Hydraulic orifice discharge shall be a minimum of 60 inches for upward discharge. Orifices shall have a protective shield.
 - f. The recommended orifice spacing is 24 inches on center; however, the maximum spacing is 36 inches. The first and last orifice shall be located 1/2 orifice space from the ends of the distribution lines.
8. Balancing Valves and Purge Valves. System shall have a balancing valve at the beginning of each perforated pressurized line and a purge valve at the end. See Figures 13.3f and g.
- a. All valves shall be encased in plastic or concrete boxes.
 - b. All balancing valves shall be PVC Schedule 40 or higher gate valves. Metallic valves are prohibited.
 - c. All purge valves shall be ball or gate PVC Schedule 40 or higher.
 - d. All boxes shall allow enough room for maintenance and adequate room to install standpipes onto the end of the purge valves.
9. There shall be a minimum three-foot segment of the transmission line in the trench prior to the beginning of the aggregate portion of the trench or prior to the gravel bed.
10. The cross section of the transmission line and the beginning of the gravel portion of the trench shall be stepped so as to prevent seepage of effluent from trench to trench.
11. Maximum length of run for a perforated pressurized line shall be 75 lineal feet.
12. In the distribution network, orifices shall be placed in upward position using an orifice shield.
13. The sump and pump installation shall be as specified in Sections 8.4 and 8.5
14. Placement of the pressurized transmission line from the sump tank to the first manifold must be a minimum of 24 inches below the surface of the ground.
15. Construct trenches with special attention to proper elevation and strict attention to contour.
16. Sidewall of trenches shall be scarified to remove all smears.
17. Place aggregate into the trench.
18. Install perforated piping, placing orifices upwards for the hydraulic test. Benching is strictly prohibited for the installation of standard pressure distribution systems regardless of the slope.
19. Placement of the pressurized transmission line from the sump tank to the first manifold must be a minimum of 24 inches below the surface of the ground. Construct trench beds with special attention to proper elevation and strict attention to contour. Sidewall of trenches shall be scarified to remove all smears. Place aggregate into the trench.
20. Install perforated piping, placing orifices upwards for the hydraulic test. Benching is strictly prohibited for the installation of standard pressure distribution systems regardless of the slope.
- F. Perform hydraulic test after the distribution system has been completed.

1. Pump must be adequate to deliver the required orifice discharge minimum of 60 inches for upward discharge to the lateral.
 2. Distribution to all laterals shall be balanced.
 3. This test shall be inspected by the designer/consultant and the Permit Authority ~~REHS~~.
- G. Establish the finished grade of the Standard PD system by track rolling and grooming by hand
- H. The performance wells criteria for a PD OWTS with a supplemental treatment unit includes the following. A minimum of four performance wells shall be installed within and around the system to a depth of 36 inches below proposed trench bottom. See Figure 11.6.
1. One or more performance wells shall be installed between trenches in the middle of the leachfield.
 2. Two performance wells shall be installed ten feet down slope of the lowest trench line.
 3. One or more performance wells shall be installed at five feet upslope of the highest trenchline.
 4. Permit Authority may require that performance well locations be changed in special situations.
 5. Performance wells shall be properly installed to provide easy access.

Section 10 Criteria for Water Reuse

10.1 Graywater

- A. The construction, alteration, and repair of graywater systems are subject to the provisions of the 2022 California Plumbing Code (CPC), Chapter 15 Alternate Water Sources for Nonpotable Applications Section 1503.0.
1. A Clothes Washer System is subject to the requirements of the 2022 CPC Section 1503.1.1.
 - a. The repair, alteration, relocation, installation, or construction of a clothes washer graywater system is exempt from a permit unless it is demonstrated that the system does not meet the requirements of the 2022 CPC Section 1503.1.
 2. A Simple System is subject to the requirements of the 2022 CPC, Section 1503.1.2.
 - a. An application for a permit, accompanied by fees as specified in the current fee resolution, is required for a Simple System.
 3. A Complex System is subject to the requirements of the 2022 CPC Section 1503.1.3.
 - a. An application for a permit, accompanied by fees as specified in the current fee resolution, is required for a Complex System.

Section 11 Criteria for Commercial, Industrial, and Institutional OWTS

11.1 Commercial, Industrial, and Institutional OWTS

- A. All commercial OWTS shall be designed by a Qualified Consultant.
- B. A typical commercial OWTS would service businesses such as, but not limited to food facilities, schools, care homes, childcare facilities, dog kennels, veterinary offices, wineries and wine-tasting rooms.
- C. To estimate non-residential domestic wastewater flow rates please refer to Table 11.1, the California Plumbing Code, Appendix H, Table H 201.1(4), or the United State Environment Protection Agency, Onsite Wastewater Treatment Manual, Table 3-4 and Table 3-5.
- D. All commercial OWTS, including pre-1971 created parcels shall provide 200 percent reserve replacement area. Dual dispersal fields consisting of a primary field and a secondary field (75 percent of design flow) with a diversion valve to alternate the field use are recommended but not required.
- E. Commercial OWTS that exceed the 1,500 gallons per day flow criteria of this section are subject to the requirements of Section 14 if supplemental treatment is utilized, or Section 11.5.
- F. For commercial uses, the minimum size of the septic tank must be based on the formula V (net volume in gallons) equals $1,125 + 0.75Q$ (daily wastewater flow in gallons),
- G. Pretreatment is required when high strength commercial wastewater is proposed. Pretreatment components and/or pretreatment system shall reduce wastewater strength to levels below the defined levels for high strength wastewater.
- H. Any OWTS that receives high strength wastewater from a commercial food service building requires a properly sized and functioning oil/grease interceptor.
- I. All wastewater flows for commercial OWTS shall meet the OWTS Policy definition of domestic wastewater.

**Table 11.1A – Multiunit and Non-Residential Design
Flow Rates for Domestic Wastewater Only**

| TYPE OF OCCUPANCY | GALLONS PER DAY |
|---|-------------------------------|
| Airports | 5 per passenger |
| Campgrounds with central comfort station | 35 per person |
| Campgrounds with flush toilet, no showers | 25 per person |
| Day Camps (no meals) | 15 per person |
| Luxury Camp, private bath | 100 per person |
| Summer and seasonal | 50 per person |
| Churches (sanctuary) | 5 per seat |
| With kitchen wastes | 7 per seat |
| Country Club | 100 per person |
| Factories | 15 per person per shift |
| Hospitals | 250 per bed space |
| Kitchen waste only | 25 per bed |
| Laundry waste only | 40 per bed |
| Hotels/Motels with private bathroom (no kitchen waste) | 60 per two-person room |
| Hotels/Motels without private bathroom (no kitchen waste) | 50 per two-person room |
| Hotel/Motel with private bath and kitchen | 75 gallons per person |
| Institutions other than hospitals | 125 per bed space |
| Movie Theaters | 5 per seat |
| Offices | 15 per employee |
| Picnic parks with toilets and showers | 10 per person |
| Picnic parks with toilet waste only | 5 per person |
| Resort camps with limited plumbing | 50 gallons per person |
| Restaurants with Kitchen waste (multi-use utensils) | 5 per meal served |
| Restaurants with Kitchen waste (disposable utensils) | 3 per meal served |
| And add the following for type of facility present: | |
| Conventional sit down | 10 per person |
| Short Order | 8 per person |
| Bar and Cocktail | 3 per person |
| School (non-boarding) | 15 per student |
| With gym and showers add | 5 per student |
| With cafeteria using disposable utensils | 3 per meal served |
| Self-service laundries | 50 gallons per waste |
| Service station | 10 gallons per vehicle served |
| Retail stores | 15 per employee |
| For public restrooms add | 1 per 10 square feet |
| Swimming pools and bathhouses | 10 per person |
| Tourist camps or mobile home parks with individual bath units | 100 per person |
| Tourist camps or trailer parks with central bathhouse | 75 per person |
| Work or construction camps (semi-permanent) | 50 per person |
| Wine tasting facility (no meals served) | 3 per person |
| Wine tasting facility with meals served (multi-use utensils) | 8 per person |
| Wine tasting facility with meals served (disposable utensils) | 6 per person |
| Employee | 15 per employee |

**Table 11.1B – California Plumbing Code
Estimated Wastewater Flow Rates**

| TYPE OF OCCUPANCY | GALLONS PER DAY |
|--|--|
| Airports | 15 per employee 5 per passenger |
| Auto washers | Check with equipment manufacturer |
| Bowling alleys (snack bar only) | 75 per lane |
| Camps: Campground with central comfort station Campground with flush toilets, no showers Day camps (no meals served) Summer and seasonal | 35 per person 25 per person 15 per person 50 per person |
| Churches(Sanctuary) with kitchen waste | 5 per seat 7 per seat |
| Dance halls | 5 per person |
| Factories: no showers with showers Cafeteria, add | 25 per employee 35 per employee 5 per employee |
| Hospitals kitchen waste only laundry waste only | 250 per bed 25 per bed 40 per bed |
| Hotels (no kitchen waste) | 60 per bed (2 person) |
| Institutions (Resident) | 75 per person |
| Nursing home | 125 per person |
| Rest home | 125 per person |
| Laundries, self-service (min 10 hours per day) Commercial | 300 per machine Per manufacturer's specifications |
| Motel with kitchen | 50 per bed space 60 per bed space |
| Offices | 20 per employee |
| Parks | |

| | |
|--|--|
| Picnic parks (toilets only) | 20 per parking space |
| Recreational vehicles: without water hook-up with water and sewer hook-up | 75 per space 100 per space |
| Restaurants - cafeterias | 50 per seat |
| Schools - Staff and office Elementary students Intermediate and high with gym and showers, add with cafeteria, add | 20 per person 15 per person 20 per student 5 per student 3 per student |
| Boarding, total waste | 100 per person |
| Service station, toilets | 1000 for 1st bay 500 for each additional bay |
| Stores Public restrooms, add | 20 per employee 1 per 10 square feet of floor space |
| Swimming pools, public | 10 per person |
| Theaters, auditoriums Drive-in | 5 per seat 10 per space |

Table 11.1C -- USEPA Onsite Wastewater Treatment Systems Manual 2002

Table 3-4. Typical wastewater flow rates from commercial sources^{a,b}

| Facility | Unit | Flow, gallons/unit/day | | Flow, liters/unit/day | | |
|---|---------------------|------------------------|---------|-----------------------|---------|----|
| | | Range | Typical | Range | Typical | |
| Airport | Passenger | 2-4 | 3 | 8-15 | 11 | |
| Apartment house | Person | 40-80 | 50 | 150-300 | 190 | |
| Automobile service station ^c | Vehicle served | 8-15 | 12 | 30-57 | 45 | |
| | Employee | 9-15 | 13 | 34-57 | 49 | |
| Bar | Customer | 1-5 | 3 | 4-19 | 11 | |
| | Employee | 10-16 | 13 | 38-61 | 49 | |
| Boarding house | Person | 25-60 | 40 | 95-230 | 150 | |
| Department store | Toilet room | 400-600 | 500 | 1,500-2,300 | 1,900 | |
| | Employee | 8-15 | 10 | 30-57 | 38 | |
| Hotel | Guest | 40-60 | 50 | 150-230 | 190 | |
| | Employee | 8-13 | 10 | 30-49 | 38 | |
| Industrial building (sanitary waste only) | Employee | 7-16 | 13 | 26-61 | 49 | |
| Laundry (self-service) | Machine | 450-650 | 550 | 1,700-2,500 | 2,100 | |
| | Wash | 45-55 | 50 | 170-210 | 190 | |
| Office | Employee | 7-16 | 13 | 26-61 | 49 | |
| Public lavatory | User | 3-6 | 5 | 11-23 | 19 | |
| Restaurant (with toilet) | Meal | 2-4 | 3 | 8-15 | 11 | |
| | Conventional | Customer | 8-10 | 9 | 30-38 | 34 |
| | Short order | Customer | 3-8 | 6 | 11-30 | 23 |
| | Bar/cocktail lounge | Customer | 2-4 | 3 | 8-15 | 11 |
| Shopping center | Employee | 7-13 | 10 | 26-49 | 38 | |
| | Parking space | 1-3 | 2 | 4-11 | 8 | |
| Theater | Seat | 2-4 | 3 | 8-15 | 11 | |

Table 11.1D -- USEPA Onsite Wastewater Treatment Systems Manual 2002

Table 3-5. Typical wastewater flow rates from institutional sources^a

| Facility | Unit | Flow, gallons/unit/day | | Flow, liters/unit/day | |
|------------------------------------|----------|------------------------|---------|-----------------------|---------|
| | | Range | Typical | Range | Typical |
| Assembly hall | Seat | 2–4 | 3 | 8–15 | 11 |
| Hospital, medical | Bed | 125–240 | 165 | 470–910 | 630 |
| | Employee | 5–15 | 10 | 19–57 | 38 |
| Hospital, mental | Bed | 75–140 | 100 | 280–530 | 380 |
| | Employee | 5–15 | 10 | 19–57 | 38 |
| Prison | Inmate | 80–150 | 120 | 300–570 | 450 |
| | Employee | 5–15 | 10 | 19–57 | 38 |
| Rest home | Resident | 50–120 | 90 | 190–450 | 340 |
| | Employee | 5–15 | 10 | 19–57 | 38 |
| School, day-only: | | | | | |
| With cafeteria, gym, showers | Student | 15–30 | 25 | 57–110 | 95 |
| With cafeteria only | Student | 10–20 | 15 | 38–76 | 57 |
| Without cafeteria, gym, or showers | Student | 5–17 | 11 | 19–64 | 42 |
| School, boarding | Student | 50–100 | 75 | 190–380 | 280 |

11.2 Special/Cultural Events

- A. The intent of this standard is to provide sizing criteria for onsite dispersal systems that are commensurate with the number and size of special events approved under the facility's permit. Generally, this standard requires larger dispersal systems as the number and size of permitted events increases.
- B. For purposes of implementation of Special Events granted in Use Permits and the use of Portable Toilets. The following definitions apply:
 1. "Event" means any special event authorized under a Use Permit or an "Occasional Cultural Event" as defined in the zoning ordinance and as interpreted by the Board of Zoning Adjustments. "Event" includes industry-wide events.
 2. "Visitors per day" means the peak number of visitors estimated for the entire busiest single day of one event, and not the combined number of visitors of both days of a week-end event, and not just the maximum number of visitors at one time during the busiest day.
- C. The wastewater system consultant shall justify the sizing of the OWTS for Special Events based on the specific circumstances of the site and the proposed event.
 1. Special Events without food service shall size the on-site wastewater dispersal system as large as needed, but in no case at less than two and a half gallons per visitor per day.
 2. Special events with food service shall size the on-site wastewater dispersal system as large as needed, but in no case at less than five gallons per visitor per day.
- D. Sizing of the OWTS for Special Event wastewater flows shall comply with the following requirements when mitigation is provided by an adequate number of portable toilets as specified in department policy governing Special Event use permits and portable toilets and partially illustrated in Table 11.2. The Special Event Wastewater Flow is the additional sewage flow expected from the largest single special event that is in excess of the normal wastewater flow from the facility

Table 11.2 – Special Events and OWTS Sizing Criteria

| Number of special events approved per year | Percent increase in the design and capacity of the facility's wastewater treatment system due to special event wastewater flows |
|--|--|
| 0 to 4 | The additional special event wastewater flow may be accommodated by portable toilets. No increase in the facility wastewater system required. |
| 5 to 10 | The design and capacity of the facilities wastewater treatment system must be increased by 25 percent of the fifth largest single special event flow. |
| 11 to 25 | The design and capacity of the facilities wastewater treatment system must be increased by 50 percent of the fifth largest single special event flow. |
| 26 or more | The design and capacity of the facilities wastewater treatment system must be increased by 100 percent of the fifth largest single special event flow. |

11.3 Flow Equalization

- A. Flow equalization is the process of controlling the rate of wastewater flow through an OWTS by providing surge capacity storage and timed-dosing of the incoming flow. Installed following the septic tank, it allows peak surges in wastewater flow (for example from a weekend event) to be temporarily stored and metered into the treatment system and/or dispersal field at a relatively even (average) rate over an extended number of days (for example during the subsequent week). This generally aids OWTS performance.
- B. Where flow equalization is proposed to be incorporated in an OWTS the following apply:
 - 1. The septic tank capacity shall be sized based on the peak daily flow for the facility.
 - 2. The design flow used for sizing supplemental treatment unit(s) and/or the dispersal field may be based on the equalized (average) flow rate rather than the peak daily flow rate for the facility.
 - 3. Engineering calculations and specifications must be submitted substantiating the proposed design and operation of the flow equalization system.
 - 4. An operational permit (per Section 14) is required for OWTS utilizing supplemental treatment.
- C. Flow equalization may be used for non-residential and mixed use facilities that experience significant, regular and predictable fluctuations in wastewater flows. Examples of applicable facilities include, but are not limited to:
 - 1. Churches;
 - 2. Schools;
 - 3. Special/Cultural event venues.

11.4 Package Treatment Plants

- A. Package Treatment Plants include systems that use wastewater in a manner subject to Title 22 wastewater reclamation standards and/or any treatment unit other than a septic tank. This does not include systems which process wastewater originating solely from agricultural uses, retail food facilities or storm water if these systems do not include any domestic wastewater component.

1. Package treatment plants cannot serve multiple uses on separate parcels under separate ownership unless the Board of Supervisors approves specific findings for multiple ownership of sewage dispersal systems.
- B. The application request for a package treatment plant must be prepared by a RCE with documented experience in the design of sewage treatment plants and must include the following:
1. A full description of the proposed collection and treatment method and process components.
 2. A full description of the proposed method for wastewater dispersal.
 3. Environmental review for California Environmental Quality Act (CEQA) compliance.
- C. The typical conditions of approval for a Package Treatment Plant include the following:
1. An independent engineering consultant acceptable to the Permit Authority shall perform peer review of the plans at the applicant's expense.
 2. A permit to construct the collection system shall be obtained from the Permit Authority prior to the start of any construction of the collection system.
 3. All applicable county permits shall be obtained for the treatment and dispersal facilities including grading, electrical, and plumbing permits.
 4. Prior to obtaining building permits for any portion of the project, Waste Discharge Requirements shall be obtained from the appropriate RWQCB.
 5. The long-term managerial and financial needs of the package treatment plant shall be fully documented.
 - a. Prior to the issuance of building permits, deed restrictions shall be recorded specifying the conditions under which the package treatment plant was approved.
 6. The package treatment plant shall be operated under a valid Sonoma County Operational Permit in accordance with an approved monitoring plan.
 7. Use of the facility shall cease if either the WDR or the County Operational Permit is revoked.
- D. For additional information and specific requirements refer to department policy on Package Treatment Plants.

11.5 Performance Wells

- A. All non-standard OWTS subject to operating permit requirements must be designed with a series of performance wells to monitor the performance of the system. In limited circumstances, performance wells may be required for standard OWTS that may present a threat to public health and/or the environment. Sampling of the liquid in the wells may be required to evaluate the treatment of the system and ensure that groundwater degradation does not occur.
- B. The construction of the performance wells shall be constructed with three or four inch approved casing and screened with 1/16 or 3/32 inch slots, and a minimum 12 inch annular concrete seal. Monterey sand or equivalent shall be placed from the bottom of the well to the depth of the annular seal. The exception to the sand fill is for wells in the gravel bed of at-grade or mound

systems. These wells shall be filled from the bottom of the well to the depth of the annular seal with pea gravel.

- C. All performance wells are designed to monitor the performance of the system to ensure groundwater degradation does not occur. Performance wells are to be located up-gradient, within, laterally, and down-gradient of the OWTS. If damage is noted during monitoring or the performance well cannot be located, the well shall be replaced by a qualified contractor in the area shown on the original design.
- D. The performance wells shall be either augured or post holed or drilled by hand after the OWTS is completed. The construction of the performance wells shall be as mandated by the Permit Authority staff. The soil shall be scarified to remove compaction or smeared soil that may seal the performance well. A backhoe shall not be utilized to excavate for a performance well.
- E. Performance well heads shall be protected and encased within plastic, concrete, or an approved type box to provide easy access. The performance well caps/lids shall be maintained for easy removal/access during monitoring and need to prevent surface water from entering the well.
- F. The depth of the annular seal for the performance wells within the gravel bed shall not exceed ~~beyond~~ the depth of the gravel bed of the OWTS.
- G. A concrete annular seal of a minimum 12 inches from the surface of native grade is required for all performance wells.
- H. Refer to Sections 11, 12, 13 and Figure 11.6 for additional performance well information and specific requirements.
- I. Performance wells may be included in OWTS designs that are not subject to operating permit requirements at the discretion of the qualified consultant.

Figure 11.5 – Performance Well Detail

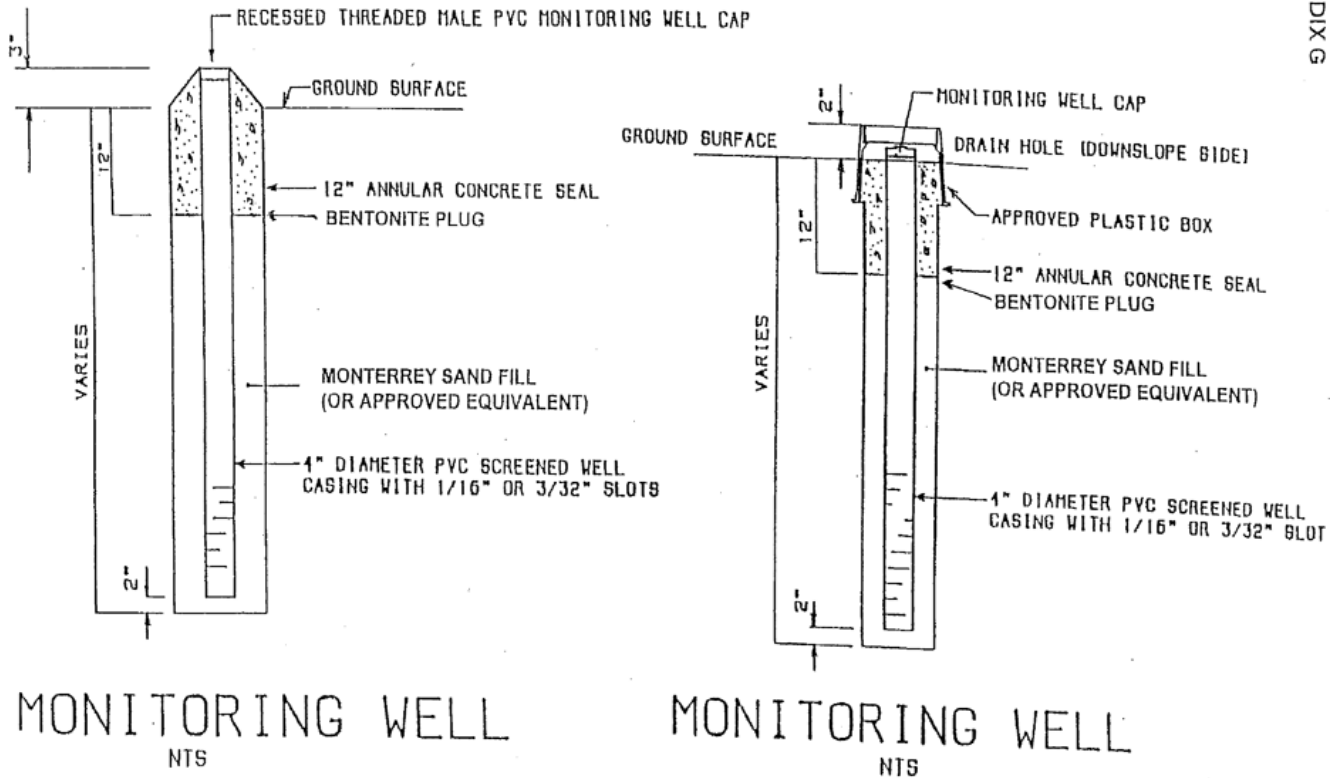

11.6 Grease Interceptors

- A. Grease interceptors are required when greater than 50 milligrams per liter of grease is introduced into a commercial OWTS.
1. Plans and specifications for grease interceptors shall be submitted to the Permit Authority for approval. Permit Authority staff shall review the grease interceptor design in accordance with minimum design and construction criteria established by Sonoma County.
 2. Waste from floor drains, floor sinks, dishwashers, pot sinks, and mop sinks shall be plumbed separately into the grease interceptor.
 3. Effluent from grease interceptors shall be disposed of in a septic tank and not directly discharged to the dispersal field.
 4. Grease interceptors shall be located, installed, and constructed so that the temperature of the sewage will be reduced to permit congealing or separation of grease, and easy access for cleaning.
 5. Commercial facilities generating up to 200 gallons per day of wastewater from the fixtures noted in Section 11.6.A.2 above, shall install an 810 gallon minimum capacity size grease interceptor or an interior pressure rated Uniform Plumbing Code (UPC) grease interceptor on the kitchen drain.
 6. Each grease interceptor shall be installed and connected so it is easily accessible for inspection, cleaning, and removal of the intercepted grease. Grease interceptors shall be located outside.

Section 12 Non-Standard Experimental and Alternative OWTS Approval Process

12.1 General

- A. There are two types of non-standard OWTS, Experimental and Alternative. Non-standard OWTS are used to overcome one or more adverse site or soil condition(s) such as high groundwater, slowly permeable soils, or other limiting conditions, or where increased wastewater treatment is needed. Unlike conventional OWTS, non-standard OWTS vary in design and concept depending on the site and soil conditions. Non-standard Experimental and Alternative OWTS with supplemental treatment are subject to the Section 14 requirements.
- B. The Permit Authority monitors the operation and maintenance of non-standard systems with supplemental treatment. Inspection frequency is dependent upon the level of monitoring compliance by the system owner/operator.
- C. Because of evolving technology and problems that may be discovered through the monitoring program, the regulations for Non-standard OWTS may change. Property owners are cautioned that regulations for Non-standard OWTS may change by action of the RWQCB or the Permit Authority. Therefore, despite previously performed and accepted work by Permit Authority, any proposal for a Non-standard OWTS must meet the regulations in effect at the time that the Permit Authority approves the OWTS permit application.
- D. When a non-standard OWTS is proposed ~~in order~~ to increase the sewage discharge of an existing use, the existing system must be brought into compliance with all current regulatory requirements.

12.2 Experimental OWTS Criteria

- A. An Experimental OWTS shall meet National Science Foundation (NSF) criteria and shall be NSF certified.
- B. An Experimental OWTS shall be capable of reliably performing settling or solids separation, nutrient and pathogen reduction comparable to a standard system consisting of a two-compartment septic tank with subsurface treatment of three feet of acceptable soil.
- C. Experimental OWTS are not authorized for the following:
 - 1. Greater than 33 percent expansion of use for existing residential and commercial systems;
 - 2. Flow rates of 600 gallons per day or more for new single family homes;
 - 3. Flow rates of 1,000 gallons per day or more for new commercial establishments;
 - 4. Subdivision of land;
 - 5. Properties within a sewer connection area, septic tank ban area, or County identified Variance Prohibition Areas, except as a repair.

12.3 Experimental OWTS Approval Process

- A. A person or company shall make an application requesting a specific design be entered into the Experimental OWTS Program.

- B. The application contents shall include:
1. Name and address of applicant,
 2. Trade name and model number, if applicable,
 3. NSF Certification,
 4. Technology description,
 5. Number of units currently in operation,
 6. Location of units currently in operation,
 7. Effluent sampling results,
 8. Estimated cost of units, installation, operation and maintenance,
 9. Discussion of specific operational requirements and/or operational training needed to successfully operate the proposed unit,
 10. Operation and maintenance manual,
 11. The appropriate filing fee.
- C. The Permit Authority staff will review each application and present any promising non-standard Experimental OWTS to the RWQCB for technical review and approval. If both Permit Authority and the RWQCB staff approve the non-standard Experimental OWTS, design parameters, site and soil characteristics, a site-specific monitoring program will be established. These provisions will be added to Section 13 of this manual.
- D. Once approved, installation of a maximum of 10 systems per year shall be allowed for new construction within each Regional Board jurisdiction with similar site and soil conditions.
- E. Intensive monitoring (two or more inspections per year) performed for at least two normal winters is required.
- F. The Permit Authority may consider whether an additional period of monitoring or an additional number of systems shall be installed prior to Alternative non-standard OWTS status consideration.

12.4 Alternative OWTS Criteria

An Alternative OWTS shall meet all of the following requirements:

1. The standards for a non-standard Experimental OWTS.
2. Enrollment in the Sonoma County Experimental Program or comparable program municipality or jurisdiction.
3. Fifty installed units that are or have been in operation for at least two years.
4. Supporting monitoring data demonstrating compliance and/or successful wastewater treatment for the 50 units.

12.5 Alternative OWTS Approval Process

- A. A person or company shall make an application requesting a specific design be entered into the Alternative OWTS Program.
- B. The application contents shall include the contents listed in Section 12.3.B.
- C. The Permit Authority staff may request the RWQCB's permission to proceed to Alternative non-standard OWTS status if the intensive monitoring indicates satisfactory results.
- D. The Permit Authority staff will review each application and present any promising non-standard Alternative OWTS to the RWQCB for technical review and approval. If both Permit Authority and the RWQCB staff approve the non-standard Alternative OWTS, design parameters, site and soil characteristics, a site-specific monitoring program will be established. These provisions will be added to Section 13 of this manual.

12.6 Approved Experimental and Alternative OWTS

A list of approved systems will be maintained on the Permit Sonoma website.

Section 13 Non-Standard Experimental and Alternative OWTS Standards

EXPERIMENTAL OWTS STANDARDS

13.1 Bottomless Sand Filter OWTS

- A. A bottomless sand filter OWTS is a raised sand filter bed dispersal system that combines features of an intermittent sand filter system and a mound dispersal system. It consists of a raised sand bed, supported by an impermeable containment structure where the bottom surface is even with or slightly below ground surface and forms the absorption surface for final dispersal of wastewater into native soil. The sand filter pretreats the effluent to improve wastewater quality and disperses the effluent into native soils. The use of bottomless sand filters is adequate to allow substantial repairs and renovations to existing residences provided there is no increase in the volume of sewage discharged.

Applicability: Areas of:

1. High groundwater;
2. Small parcel size;
3. Shallow soil over impermeable soil or bedrock.

- B. The site criteria for bottomless sand filter OWTS includes the following:

1. The sand filter may serve an existing structure located on the 100 year flood plain; and
2. The sand filter shall be located at least 100 feet from the summertime banks of the waterway;and
3. The sand filter will be located on deep, well drained soils without elevated watertable levels and will meet all other setback requirements.
4. Under these conditions, a reduction or elimination of replacement area may be permissible.

- C. The design criteria for bottomless sand filter OWTS includes the following:

1. The design of bottomless sand filters is based on the March 2014 Washington State Department of Health publication "Sand Lined Trench Systems" or most current version.
2. A containment support structure/vessel shall:
 - a. Be designed and built so that the top of the liner is at least six inches above natural grade to prevent rainwater intrusion.
 - b. On sites sloped greater than one percent, prevent surface runoff from adversely affecting the OWTS. Two options include an upslope surface intercept or grading to redirect the surface runoff.
 - c. The containment vessel must be designed by a qualified engineer and have a support foundation to prevent vertical and horizontal movement of the vessel.
 - d. The vessel may be reinforced poured-in-placed concrete or an equivalent impermeable structure concrete liner or pressure-treated wood. Alternative materials may be used with the

- approval of the Permit Authority.
- e. The liner of the containment vessel shall be impermeable to prevent lateral leakage out of or into the filter.
 - f. The sides of the containment vessels shall be lined with a minimum thickness, 30-thousands of an inch PVC membrane liner.
 - g. The liner shall extend up the sides of the support structure with enough excess to allow the liner to be firmly anchored.
 - h. All seams shall be factory heated or solvent welded.
 - i. A factory fabricated boot where the pressure line passes through the liner is required. The boot must extend into the containment vessel ~~box~~. All fittings must extend into the liner and be watertight.
 - j. Use of a non-woven needle punched synthetic geo-textile fabric in a thickness appropriate to protect the liner is required.
 - k. Both the filter media surface and the sand-original soil interface must be level.
3. The bottomless sand filter must be installed into a minimum of six inches of native undisturbed soils and consist of the following components:
 - a. A minimum of 24 inches of ASTM C-33 sand filter media below the gravel distribution bed.
 - b. A distribution bed consisting of six to twelve inches of gravel bed with pressurized piping;
 - c. An approved geo-textile followed by six to twelve inches of earth backfill.
 4. Effluent distribution from the sump to the sand filter shall be:
 - a. The manifold, lateral piping and fittings must be at minimum Schedule 40 PVC or Schedule 80 PVC if threaded fittings are utilized.
 - b. Pressure transport piping and all joints in the manifold piping, lateral piping, and fittings must be solvent welded and watertight.
 - c. A gate valve and check valve must be placed on the pressure transport pipe, in or near the sump tank, as appropriate.
 - d. Pressure lateral distribution piping and fittings must be a minimum of 1 inch in diameter.
 - e. Pressure manifold and transport piping shall be appropriately sized for the system dosing flow rates and shall meet specifications of the manufacturer.
 - f. Hydraulic orifice discharge shall be a minimum of 60 inches for upward discharge. Orifices shall have a protective shield.
 - g. Orifices must have a minimum one eighth inch diameter and be placed a maximum distance of 30 inches apart.
 - h. A purge assembly shall be provided at the end of each lateral distribution for flushing and

inspection. Purge valve assemblies shall terminate in an accessible valve box.

- i. The distribution lateral shall have six or twelve inches of gravel beneath the pipe, two inches of gravel above the pipe and be covered with an approved geo-textile filter prior to placement of six to twelve inches of soil cover.
- j. The sand filter maximum dosage is 90 gallons per cycle. Electronic timed meters are preferred over float (on demand) type controls.

5. Sizing the Infiltrative Surface - The minimum required infiltrative surface area (the top surface of the filter media) must be determined by dividing the design flow estimate by the sewage Application/Soil Loading Rate. In no case shall effluent be applied to the bottomless sand filter at a rate exceeding 1.0 GPD/SF.

D. The performance well criteria for bottomless sand filter OWTS includes the following:

- 1. One or more performance wells shall be installed in the sand filter to a depth of the upper gravel and sand interface.
- 2. One or more performance wells shall be installed in the sand filter to a depth of the lower gravel and sand interface.
- 3. Sites sloping greater than one percent:
 - a. One or more performance wells shall be installed 10 feet upslope of the sand filter.
 - b. One or more performance wells shall be installed 10 feet down slope of the sand filter.
 - c. One or more performance wells shall be installed 25 feet down slope of the sand filter.
- 4. Sites sloping less than or equal to one percent:
 - a. One or more performance wells shall be installed on each of the two longitudinal sides of the sand filter 10 feet from the edge of the sand filter.
- 5. Performance wells on the perimeter or outside the sand filter shall be at a depth of 24 inches below the bottom of the sand media.
- 6. All performance wells shall be designed and constructed consistent with Figure 11.6

13.2 Gravel-less Pressurized Dispersal Channel (GPDC)

A. Gravel-less Pressurized Dispersal Channel (GPDCs) OWTS are designed for subsurface dispersal of high-quality effluent after supplemental treatment. The pressurized perforated pipes are placed in half pipes or chambers and channels rather than in drain rock.

There are two typical configurations. The first consists of perforated laterals laid in a 12-inch-wide infiltration channel, covered with sections of plastic half-pipe and shallowly buried in native soil. The second uses an 18-inch infiltration channel and sections of 8-inch low-profile HDPE chamber material.

Applicability: Areas of:

1. High groundwater;
2. Limited acceptable soil.

B. The site criteria for GPDC OWTS includes the following:

1. Depth to a limiting condition and permeable soils below the dispersal line shall be a minimum of 24 inches. Acceptable percolation rates shall be one to 120 minutes per inch.
2. The soil above the PVC line proposed depth shall be permeable (one to 120 minutes per inch). This excludes massive or platy structured soils. Soils subject to flooding, excessive irrigation, farming practices, grading, ripping or rototilling are also not acceptable. The quality of acceptable soils above the line shall be equal to those below the line.

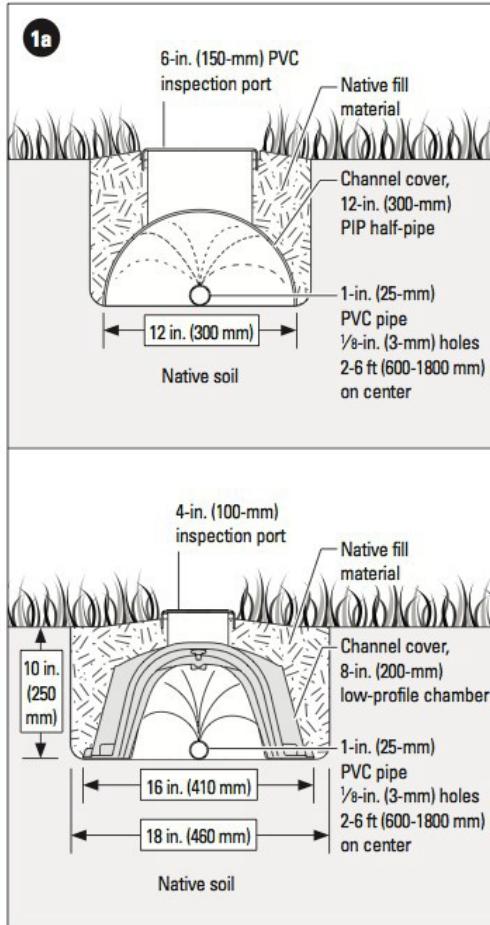

Cross sections of typical half-pipe and low-profile SPDS installations showing dimensions and materials

3. A minimum of 24 inches of permeable soil below dispersal depth shall extend a horizontal distance of no less than 25 feet down gradient from the edge of the last proposed line, including expansion areas.

4. GPDC sites shall not exceed 25 percent slope when fill is placed over the dispersal system.

C. The design criteria for GPDC OWTS includes the following:

1. Sizing the Infiltration Rate. The infiltrative area is the trench bottom area. The minimum area shall be determined by dividing the design flow estimate by the sewage Application/Soil Loading Rate.

2. Separation between laterals shall be a minimum of three feet.

3. GPDC installations space orifice holes 24 inches minimum to 72 inches maximum on center.

4. A GPDC System is typically installed 10 inches into native soil. A minimum native soil depth of six inches may be allowed with disinfection. The minimum soil cover over the orifice shield is two inches. The maximum soil cover allowed is 18 inches.

(See Illustration 1a.)

5. The designer shall also determine the number of zones, the number of doses, the quantity of the dose, the head losses, spacing of lines, spacing of orifices, diameter of the pipe (typically one-inch PVC), and pump size.
6. The length of each dispersal line shall not exceed 75 feet to ensure equal distribution to each orifice. If multiple zones are designed, dosing must be automatically alternated between each zone.
7. All GPDC Systems require an approved packed bed media filter supplemental treatment unit for treating septic effluent. The level of supplemental treatment must comply with NSF Standard 40 or at the approval of the Permit Authority.
8. Designer shall employ measures to prevent uneven distribution of the dispersal field due to drain down following a pump cycle. Per California Plumbing Code, spring check valves are not allowed for wastewater applications.
9. Provide two feet of solid pipe between the manifold and the first orifice.
10. At the end of each lateral, install a sweep ell (or two 45-degree elbows) and a ball valve with a threaded plug.
11. All system components shall be appropriately sized for the system dosing flow rates and shall meet the manufacturer's specifications. All transport piping, supply and return manifolds, and fittings must be Schedule 40 PVC or Schedule 80 PVC if threaded fittings are utilized. All filters must be sized to operate at a flow rate greater than or equal to the maximum design discharge rate of the system.

12. All GPDC System designs shall demonstrate that sufficient suitable area exists to construct 200 percent reserve area. Because GPDC Systems are experimental, in cases of split system designs, the GPDC System shall be installed as the primary system, and the other type of dispersal system shall be the 200 percent expansion system.

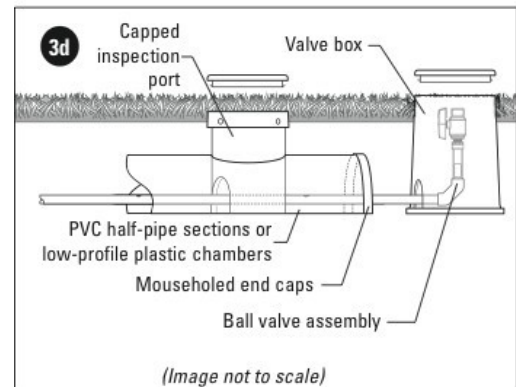

13. Totalizing flow meters (in gallons) are required on the supply line. Flow meters must be installed in a readily accessible location for reading and servicing.

14. A controller capable of timed dosing is required.

15. Disinfection of the treated wastewater shall be incorporated in cases of well-drained soils (less than one minute per inch or faster) or where dispersal systems only have a minimum of six inches of native soil cover above the shield (see Illustration 3d). Disinfection will not be required if six inches of approved fill is added above the six inches of native soil cover.

16. For aerobic treatment unit (ATU) systems that function with external blowers, a cutoff switch or interlock that disables the pump must be built into the control panel so the blower may not be disconnected.

D. Construction criteria for GPDC OWTS includes the following:

1. Construct trenches with special attention to proper elevation and contour.

- a. Shallow trenches can be dug by hand or with a trenching machine.
 - b. Trenches shall not be installed when the soils are wet or in an excessively damp state.
 - c. Sidewall of trenches shall be scarified to remove all smears.
 - d. Install perforated piping, placing orifices upwards for the hydraulic test.
 - e. Trenches can be straight, or they can be curved to fit terrain and complement vegetation, but they must be set on level grade.
 - f. Lay the half-pipe (or low-profile chamber) sections over the laterals, overlapping the section ends by a few inches. For covering curving laterals, half-pipe section ends can be cut at an angle and overlapped to match the curve of the lateral. Install 1 inspection port halfway along each lateral (see Illustration 1a).
 - g. All GPDC shall be protected from gopher soil movement with hardware wire or similar.
2. Valves must be readily accessible for service and/or inspection. All valve boxes must be protected from gopher soil movement. A detail of the valve box must be included on the plans. Specify concrete, hardware wire or similar bottom.
 3. Perform hydraulic test after the distribution system has been completed.
 - a. Size of orifice shall be 1/8 to 3/16 of an inch.
 - b. Pump must be adequate to deliver the required orifice discharge range of 24 (3/16 hole) and 60 inches (1/8 hole) for upward discharge to the lateral.
 - c. Distribution to all laterals shall be balanced.
 - d. This test shall be inspected by the designer/consultant and Permit Authority.
- E. Establish the finished grade of the GPDC OWTS by track rolling and grooming by hand. Backfill the excavation with caution. Do not compact the soil around the half-pipe or chamber.
- F. Fill material may only be placed above native soil for soil cover and shall not be used to meet required soil depth minimums. The system designer shall describe the type of fill to be placed in terms of texture and structure, and the depth and method of ripping before placement. No part of the GPDC dispersal field may be located where the site slope exceeds 25 percent when fill is used.
1. A ground cover (turf, fruit trees or other appropriate landscaping) must be planted over the dispersal field after installation to provide additional treatment, prevent erosion and increase wastewater reuse through plant evapotranspiration.
 2. Native material is acceptable if there are no large or sharp rocks that may damage the pipewalls. If native material is not usable, backfill with sand or pea gravel, or use an imported material that is approved by your local Permit Authority.
 3. Install performance wells and complete all details as shown on the plans.
- G. The performance well criteria for GPDC OWTS includes the following. A minimum of five performance wells shall be installed within and around the system to a depth of 24 inches below proposed trench bottom. (See Figure 11.6.)

1. Two performance wells shall be installed between trenches in the middle of the leachfield.
2. Two performance wells shall be installed 25 feet down slope of the lowest trench line.
3. One performance well shall be installed at 10 feet upslope of the highest trench line.
4. Additional performance wells may be required for systems longer than 75 feet.
5. The Permit Authority may require that performance well locations be changed in special situations.
6. Performance wells shall be properly installed to provide easy access.

ALTERNATIVE OWTS STANDARDS

13.3 Mound OWTS

- A. Mound systems accept septic tank effluent and disperses the effluent evenly through pressurized perforated pipes in a gravel bed that percolates through a sand layer that is installed directly on top of ripped native soil. The gravel bed is covered with an approved silt barrier, then with loam or a similar soil. The effluent percolates from the sand layer into the native soil.

Applicability: Areas of:

1. High groundwater;
2. Shallow soil over fractured rock or coarse alluvium;
3. Shallow soil over impermeable soil or bedrock;
4. Slower percolation rates (60 – 120 MPI) at standard dispersal field depths.

- B. The site criteria for Mound OWTS includes the following:

1. Percolation rate of one to 120 minutes per inch
 - a. Percolation rate requirements apply to the first 24 inches of soil as measured from native grade. See Section 7.
 - b. Rates faster than one minute per inch are not acceptable.
2. Minimum elevated groundwater level is 24 inches from native grade.
3. Minimum depth of suitable permeable soil is 24 inches from native grade.
 - a. The rock content (as retained on the #10 Sieve) shall not exceed 50 percent by volume within the first 24 inches of soil from native grade.
 - b. The minimum depth to fractured rock, impermeable soils, such as hardpans and claypans, and consolidated bedrock is 24 inches.
 - c. The addition of an approved pretreatment unit does not mitigate 1 foot of the required minimum 24 inches of suitable soil beneath the mound. 2 feet of acceptable native soil from native ground is required.
4. For sites greater than one percent slope, the minimum depth of permeable soil is 24 inches and of the sand perimeter. For sites one percent slope or less, the minimum depth of

permeable soil is 24 inches and shall extend a minimal horizontal distance of at least 10 feet in all directions from the edge of the sand perimeter.

5. Avoid designing the system in an area of rock out croppings, boulders and trees. When it is unavoidable due to having no other viable location for the system, then the basal area will need to be increased to compensate for the reduced soil availability.
6. The separation distance between individual primary mound systems shall be as follows:
 - a. The downslope distance shall be zero feet.
 - b. The side slope distances shall be four feet.
7. The separation distance between a primary mound system and a reserve mound system shall be as follows:
 - a. The downslope distances shall be zero feet.
 - b. The side slope distances shall be two feet.

Table 13.3a – Mound Separation Distances

| Primary System to | Downslope | Side Slope |
|-------------------|-----------|------------|
| Primary System | 0' | 4' |
| Reserve System | 0' | 2' |

8. The separation distances shall be measured from the following features:
 - a. Downslope separation distances shall be measured from the down slope sand toe of the primary mound to the upslope sand toe of the secondary or reserve mound.
 - b. Side slope separation distances shall be measured from the end of the aggregate area of the primary mound to the end of the aggregate area of the secondary or reserve mound.
 9. The downslope separation distances may be reduced provided the design and site evaluation parameters demonstrates there is no horizontal movement of the effluent upon dispersal and that hydraulic mounding will not occur.
- C. The design criteria for mound OWTS (see Figures 13.3a and 13.3b) includes the following:
1. Wastes with a high biological oxygen demand are not suitable for mound systems without approved pretreatment sufficient to lower the waste strength to the level of that septic tank effluent as specified in Section 13.8.
 2. Distribution (Gravel) Bed
 - a. Sand Fill Loading Rate
 - a. 1.0 gallon per square foot per day for residential type systems
 - b. 0.8 gallons per square foot per day for all commercial type systems

c. Reduced loading rates for high strength waste may be required.

3. Linear Loading Rate

- a. Designers shall estimate the linear loading rate for all proposed mound OWTS and shall design the width dimensions of the gravel bed accordingly, so that the distribution bed is long and narrow and on the contour.
- b. When the depth to a limiting condition, for example, impermeable soil layer or rock is only 24 inches, the linear loading rate shall not exceed 4 gallons per lineal foot per day.
- c. If it can be demonstrated that the wastewater flow will be vertical, as well as horizontal, a higher loading rate may be proposed.
- d. Refer to Table 13.3b and Figure 13.3a for the Linear Loading Rates based on Limiting Conditions.

Table 13.3b – Linear Loading Rates (LLR) Based on Limiting Conditions

| Nature of Limiting Condition | LLR Range (gpd/linear ft) |
|-------------------------------|---------------------------|
| Solid Bedrock | 3-4 |
| Impermeable Soil Layer | 3-4 |
| Semi-Permeable Soil Layer | 5-6 |
| Fractured Compacted Till | 5-6 |
| Seasonal High Water Table | 6-8 |
| Creviced or Fractured bedrock | 8-10 |
| Sand and/or Gravel Layer | 8-10 |

Figure 13.3a – Linear Loading Rate

Mound System overlaying a permeable soil lens over creviced bedrock. Estimated linear loading rate equals 8 to 10 gallons per day per linear foot.

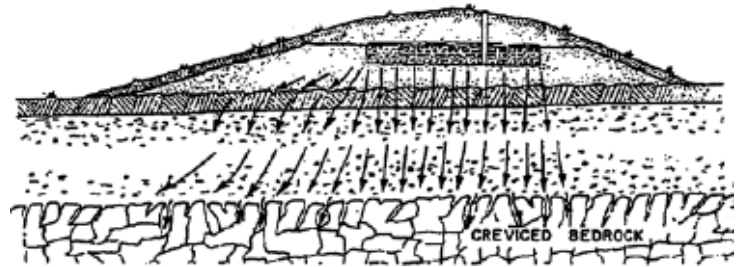

Mound System overlaying a deep permeable soil lens over a fluctuating water table. Estimated linear loading rate equals 6 to 8 gallons per day per linear foot.

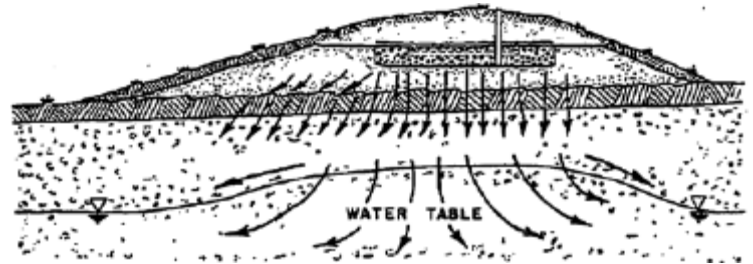

Mound System overlaying a shallow permeable soil lens over a semi-permeable soil layer. Estimated linear loading rate equals 5 to 6 gallons per day per linear foot.

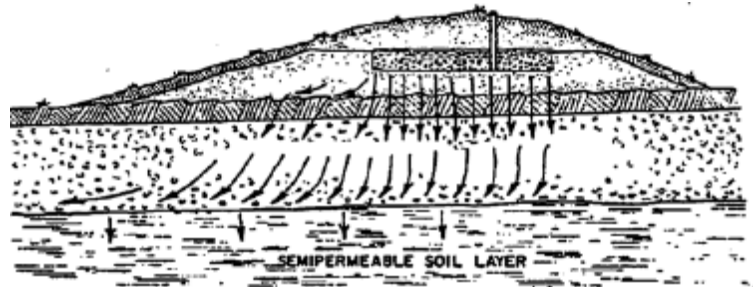

Mound System overlaying a shallow permeable soil lens over an impermeable soil layer. Estimated linear loading rate equals 3 to 4 gallons per day per linear foot.

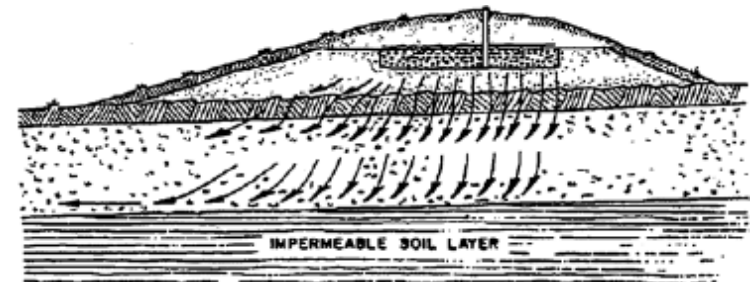

4. Infiltration Area (Dispersal/Gravel Bed)

- a. The Infiltrative Surface Area (square feet) equals Daily Design Flow (gallons per day) divided by Sand Fill Loading Rate (see section 13.3.C.2.a for sand fill loading rates).

Figure 13.3b – Mound Cross Section

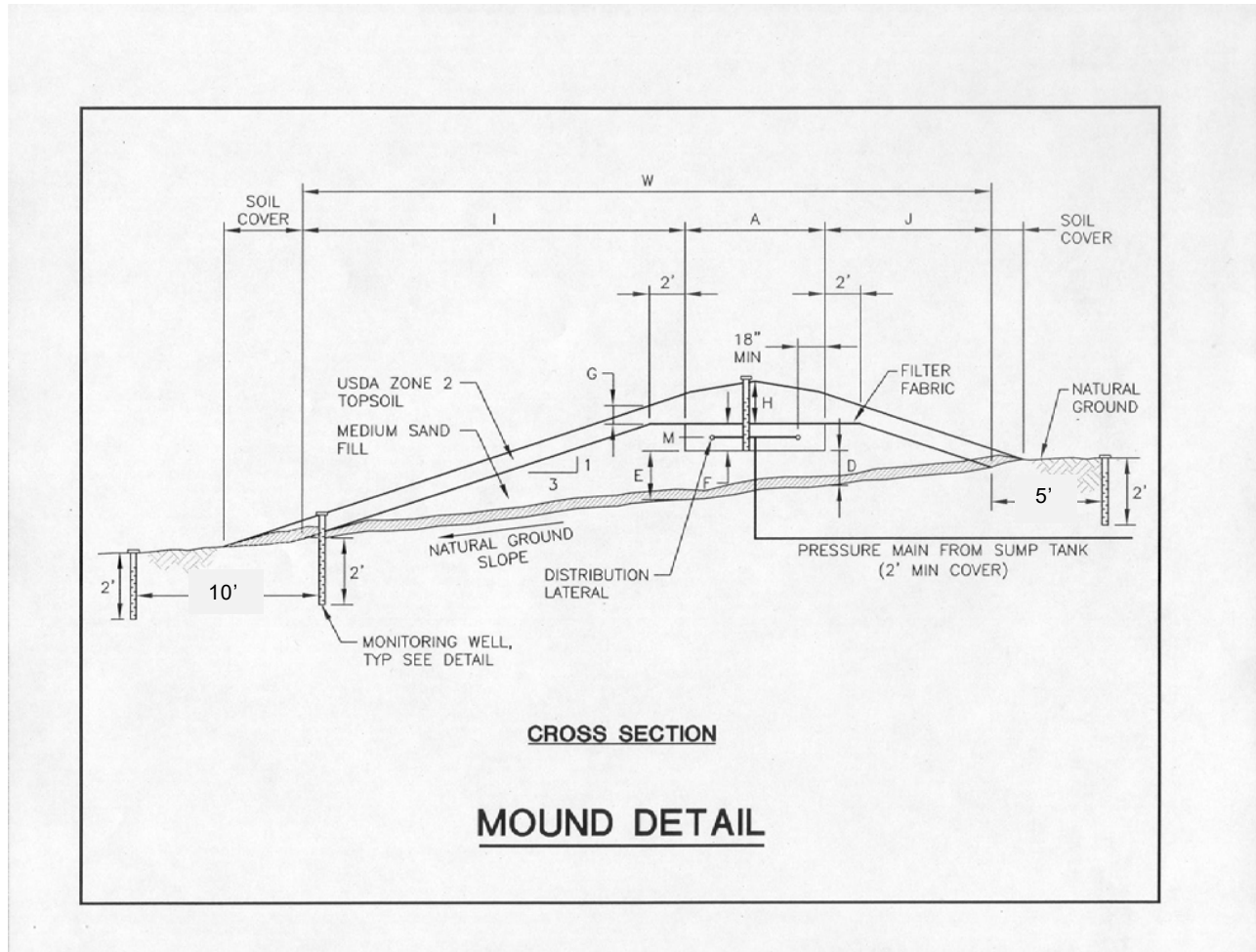
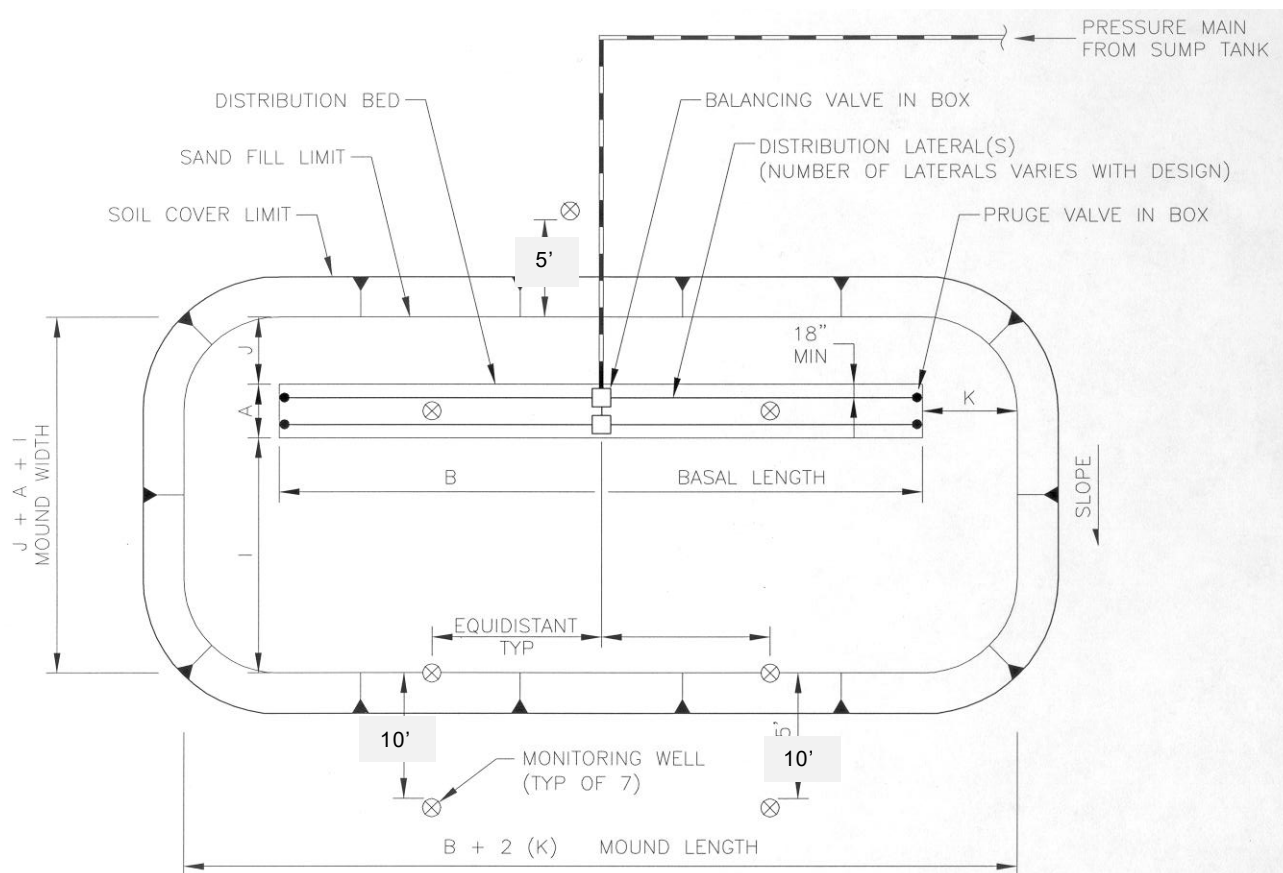

Figure 13.3c – Mound Plan View



MOUND - PLAN VIEW

- b. Dispersal Gravel Bed Width (A) —The dispersal gravel bed width is determined by the Linear Loading Rate in gallons per day per linear foot of certain soil type and depth. Linear Loading Rates are shown in Table 13.3a and Figure 13.3a. Maximum bed width shall be 10 feet. The dispersal bed width equals the Linear Loading Rate divided by the Sand Fill Loading Rate.
 - c. Dispersal Gravel Bed Length (B) equals the design flow rate in gallons per day divided by the linear loading rate in gallons per day per linear foot.
 - d. Dispersal Bed Depth (F) equals the minimum of six inches of aggregate for residential or nine inches for commercial systems and mixed commercial/residential uses placed beneath the distribution pipe plus the two inches of aggregate placed around and above the pipe.
 - e. Dispersal Gravel Bed Grade—The bottom of the dispersal gravel bed must be level.
5. Basal Area (Sand Filter Media)
- a. Sand Filter Media Depth—The depth of sand filter media shall be at least 12 inches under all parts of the dispersal gravel bed.
 - b. The depth of sand filter media below the dispersal bed varies with ground slope according to

the following formulas:

1. Sand Filter Media Depth below upslope edge of dispersal bed (D) equals one foot.
 2. Sand Filter Media Depth below downslope edge of dispersal bed (E) equals one foot plus the product of the percent natural slope as a decimal multiplied by the width of the dispersal gravel bed (A).
 - c. Sand Filter Media Length and Width—The length and width of the sand filter media are dependent upon the length (B) and width (A) of the dispersal gravel bed, filter media depth (F) and side slopes of the filter media.
 - d. Side slopes must be no steeper than two to one (for example two feet of run to every one foot of rise).
 - e. The sand filter media length equals the end slopes (K) plus the dispersal gravel bed length (B).
 - f. The sand filter media width equals the upslope width (J) plus the dispersal bed width (A) plus the downslope width (I). On sloping sites, the downslope width (I) will be greater than on a level site if a 3 to 1 side slope is maintained. Table 13.3b gives the slope correction factor multiplier for slopes from 0 up to 20 percent with a 3 to 1 side slope.
 - g. The sand fill shall be level and extend a minimum of 24 inches horizontally beyond the dispersal bed on all sides, and then uniformly sloped as determined by the mound dimensions.
 - h. On slopes greater than two percent, the 24-inch dimension may be reduced to 12 inches on the uphill side of the distribution bed.
6. Basal Area Calculation—The amount of sand basal area required is dependent upon the permeability of the original soil.
- a. For level sites the total basal area [length of filter media (L) times width of filter media (W)] beneath the filter media is available for effluent absorption into the soil.
 - b. For sloping sites, the only available basal area is the area beneath the dispersal bed (A times B) and the area immediately downslope from the dispersal bed [bed length (B) times downslope width (I)]. It includes the area enclosed by [B times (A plus I)]. The upslope and end slopes will transmit very little of the effluent on sloping sites and are therefore disregarded.
 - c. The available basal area must equal or exceed the required basal area (aa) Basal arearequired equals Daily flow divided by Soil Infiltration rate (bb) Basal area available equals B times (A plus I plus J) on level sites or B times (A plus I) on a sloping site.
7. Slope Width and Length of the Mound System
1. For sloping sites the downslope width (I) and upslope width (J) are a function of the depth of the sand fill below the respective downhill or uphill side of the dispersal bed, the desired side slope, three to one, and the slope correction factor. See Table 13.3c.
 2. For level sites and end slope length (K), no slope correction factor is used.
 3. Upslope width (J) equals (D plus F) times three times the upslope correction factor.

4. Downslope width (I) equals (E plus F) times three times the downslope correction factor.
5. End slope length (K) equals {(D plus E) divided by two plus F} times three.

Table 13.3c – Mound Slope Correction Factors

| Slope Percentage | Downslope (I) Correction Factor | Upslope (J) Correction Factor |
|------------------|---------------------------------|-------------------------------|
| 0 | 1 | 1 |
| 2 | 1.06 | .94 |
| 4 | 1.14 | .89 |
| 6 | 1.22 | .86 |
| 8 | 1.32 | .80 |
| 10 | 1.44 | .77 |
| 12 | 1.57 | .73 |
| 14 | 1.72 | .71 |
| 16 | 1.92 | .68 |
| 18 | 2.17 | .65 |
| 20 | 2.50 | .62 |

8. Configuration

- a. Only single dispersal gravel beds are acceptable. Dual beds are not allowed.
- b. The maximum width of any gravel bed is 10 feet.
- c. The depth of the gravel bed shall be six inches below the pipe for residential systems and nine inches for commercial systems and include two inches of gravel cover over the pipe.

9. Aggregate

- a. 3/8 inch double washed pea gravel size to 2.0 inch double washed drain rock.
- b. The percentage of fines (less than .035 millimeters) of washed gravel shall not exceed one percent by weight.

10. Natural Contour

- a. The dispersal gravel bed shall explicitly follow the natural contour of the ground.
- b. The dispersal gravel bed must be installed within a tolerance of three inches vertically per 100 feet horizontally.
- c. Dispersal gravel beds shall be angled or curved to meet this requirement.
- d. The dispersal gravel bed shall not be placed in a concave landscape position.

11. Sand Fill (Basal) Area

- a. The sand-fill (basal) area shall at a minimum, provide adequate basal (absorption area). The sand area size is based upon the average percolation rate and the sewage application rate chart. See Table 7.2a.
- b. Sand fill media shall conform to the ASTM C-33 sand with less than five percent fines less

than 0.53 millimeter sand specification to Wisconsin mound criteria (see Table 13.3d and Figure 13.3d).

Table 13.3d – Mound Sand Specification

| Sieve Size Number | Percent Passing |
|-------------------|-----------------|
| 3/8 | 100 |
| 4 | 95-100 |
| 8 | 80-100 |
| 16 | 50-85 |
| 30 | 25-60 |
| 50 | 10-30 |
| 100 | 2-10 |
| 200 | 0-5 |

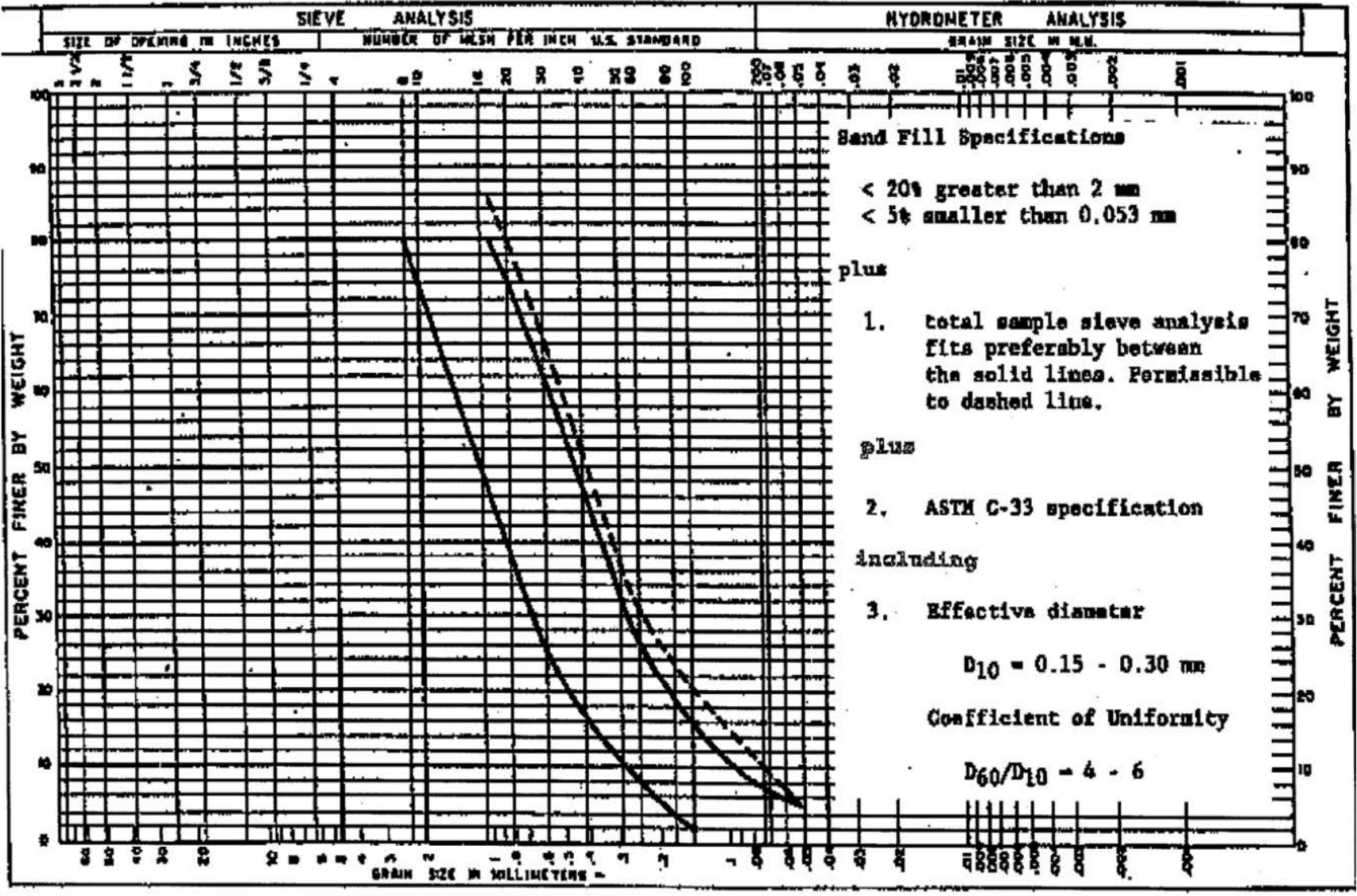

Figure 13.3d Mound Sand Criteria

- c. For ground slopes greater than one percent, the area uphill from the edge of the gravel distribution bed shall not be included in the calculations for the required basal area.
- d. Areas beyond the distal end of the gravel bed shall not be included in the calculations for the required basal area for systems exceeding one percent slope.

12. Sand Fill Configuration

- a. The toe of the sand fill shall follow contour and shall not deviate more than three inches vertically per 100 feet horizontally.

Figure 13.3e – Contour Conformance

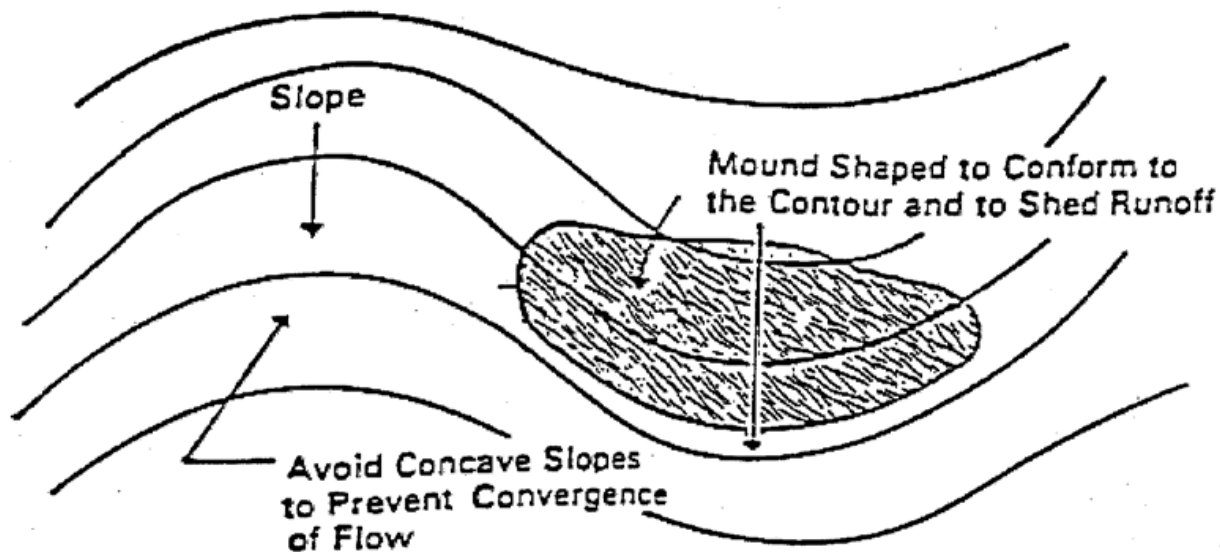

- b. The sand fill configuration shall extend a minimum of 24 inches level from the edge of the distribution bed on all sides, then uniformly slope as determined by the mound dimensions. On the slopes greater than two percent, the 24-inch dimension may be reduced to 12 inches (minimum) on the uphill side of the distribution bed only.

13. Soil Cover

- a. A minimum of six inches in depth after settling over the gravel bed portion of the mound and over the remainder of the sand portion.
- b. Mounded to a height of 12 inches after settling at the midsection of the gravel bed.
- c. The distal ends and uphill sides soil cover width requirements are four feet.
- d. Downslope soil cover shall conform to Table 13.3e.
- e. The quality of the soil structure and texture (USDA Classification) shall be at least equal to that of the topsoil existing on the site.

Table 13.3e – Mound/At-Grade Downslope Soil Cover Requirements

| Slope Percentage | Cover (lineal feet) |
|------------------|---------------------|
| 0-2 | 4 |
| 2-4 | 6 |
| 4-6 | 8 |
| greater than 6 | 10 |

14. Distribution System

- a. Designers shall calculate the total dynamic head loss of the entire distribution systems.
 - a. Vertical differences.,
 - b. Length of entire piping system.
 - c. Loss of all valves, tees, elbows, and appurtenances.
 - d. Head Loss shall be referenced as feet of elevation.
 - e. Hydraulic orifice discharge shall be a minimum of 60 inches for upward discharge. Orifices shall have a protective shield.
 - f. Orifice spacing shall be a maximum of 36 inches on center. (Closer spacing is preferred.)
 - g. Size of orifice shall be 1/8 to 3/16 of an inch.
- b. System distribution manifolds shall have a balancing valve at the beginning of each perforated pressurized line and a purge valve at the end.
 - a. All valves shall be protected and encased within plastic, concrete or other approved type box to provide easy access and maintenance. Metallic valves are prohibited.
 - b. Box size shall be 10 inches across or larger, round or square, and must allow enough room for maintenance and/or to install standpipes onto the ends of the purge valves
 - c. Balancing valves shall be PVC Schedule 40 or higher gate valves.
 - d. Purge valves shall be PVC Schedule 40 or higher gate or ball type valves.
 - e. Valve boxes shall be placed on screen blocks or equivalent and shall be designed, installed, and maintained to prevent soil and rodent intrusion into the box. See Figures 13.3f and g.

Figure 13.3f – Balancing Valve

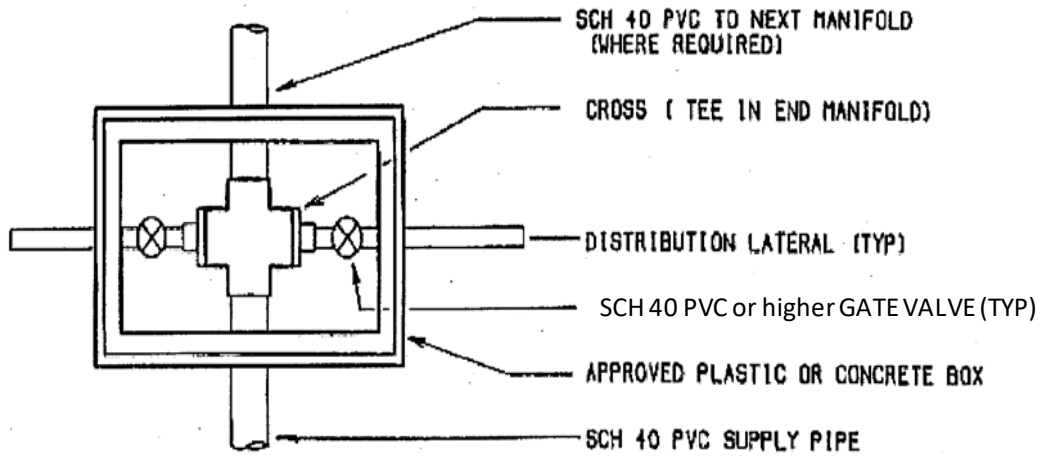

PLAN VIEW
BALANCING VALVE DETAIL

Figure 13.3g – Purge Valve

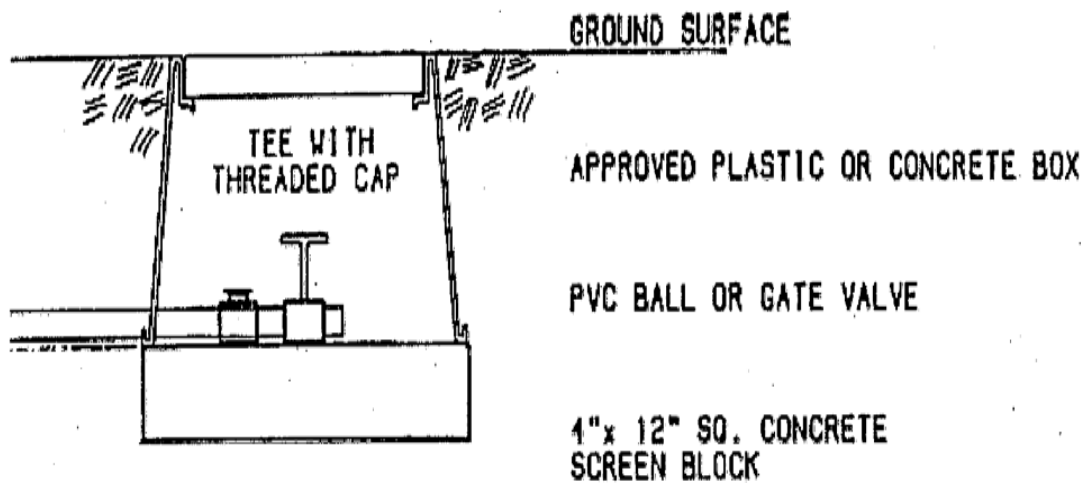

PURGE VALVE DETAIL
NTS

- c. Spacing of pressurized lines shall be based on gravel bed width.
 - a. A Gravel bed width of three to four feet allows one pressurized line.
 - b. A Gravel bed width of four to six feet allows two pressurized lines.
 - c. A Gravel bed width of six to eight feet allows three or four pressurized lines.
 - d. A Gravel bed width of eight to ten feet allows four or five pressurized lines.
- d. Distribution piping shall be Schedule 40 PVC or greater of at least $\frac{3}{4}$ inch diameter.
- e. Maximum length of pressurized lines shall be 75 feet.
- f. Maximum distance between perforations shall be 36 inches.
- g. Perforations shall be directed upward and must be protected with a shield.

15. Sump and Pump

- a. Refer to Sections 8.4 and 8.5 for required sump and pump features.

16. Refer to Figures 13.3b and 13.3c for the sizing calculations for all mound dimensions.

D. The construction criteria for Mounds includes the following:

1. These specifications must be included in the system plans submitted with the Permit Authority. The use of wheel type vehicles is prohibited,
 1. For the purpose of ripping.
 2. When driving on any areas that have been ripped.
 3. When driving on the sand fill.
 4. When placing or moving the soil cover.
 5. At any time that soil conditions are wet, moist, or saturated.
2. Placement of the pressurized transmission line from the sump tank to the mound manifold shall be a minimum of 24 inches below the surface of the ground.
3. Site preparation of soil surface to a depth of eight to 12 inches.
 - a. Mow excessive vegetation.
 - b. Cut and remove trees.
 - c. Cut trees or grind stumps to ground level.
4. Perform initial ripping parallel to the contours of the ground within the limits of the sand base; rippers set eight to ten inches apart.

5. After all the sand has been placed and prior to mound soil cover placement, rip the native soil that will interface with the mound soil.
6. Prohibit all traffic on any ripped surfaces until the full depth of fill or cover material has been placed.
7. Uniformly place and compress the sand fill by track rolling a neat line to the grade determined by the mound dimensions. A tolerance of no more than three inches vertically per 100 feet horizontally. Add additional sand as the sand fill area is compressed.
8. Construct gravel bed with special attention to proper elevation
 - a. Temporary form boards are required for placement of the distribution bed gravel.
 - b. Form boards shall be fully enveloped by the sand bed and shall be removed prior to cover placement.
9. Perform hydraulic test after the distribution system has been completed.
 - a. Hydraulic orifice discharge shall be a minimum of 60 inches for upward discharge.
 - b. Orifices shall have a protective shield.
 - c. Distribution to all laterals shall be equal.
 - d. This test shall be inspected by the consultant and the Permit Authority staff.
10. Condition soil cover material with sufficient moisture to allow track rolling to a firm cohesive surface.
11. Establish the finished grade of the mound by track rolling and grooming by hand.
12. On sites sloped greater than one percent, prevent surface runoff from adversely affecting the OWTS. Two options include a surface intercept or grading to redirect the surface runoff.
13. Install monitoring wells and details as shown on the plans.

.E. The performance wells criteria for mounds includes the following:

1. Mound OWTS with supplemental treatment requires a minimum of seven performance wells within and around the mound system pursuant to Figures 13.3b and 13.3c. Performance wells shall be constructed pursuant Figure 11.6.
 - a. Two performance wells extending to the bottom of the gravel bed shall be installed within the distribution gravel bed in proportionate locations.
 - b. Performance wells on the perimeter or outside the dispersal system shall be at a depth of 24 inches.
 - c. Sites sloping greater than one percent:
 1. Two performance wells shall be installed on the down slope side at the toe of the basal area of the mound at proportionate locations from the mound centerline.

2. Two performance wells shall be installed on the down slope side at ten feet down slope from the basal area of the toe of the mound at proportionate locations from the mound centerline.
 3. One performance well shall be installed five feet upslope from the edge of the upslope basal area at mound centerline.
- d. Sites sloping less than or equal to one percent:
1. Two performance wells shall be installed on each of the two longitudinal sides of the mound at the basal area of the toe of the mound at proportionate locations from centerline.
 2. One performance well shall be installed on each of the two longitudinal sides of the mound at the mound centerline 10 feet from the edge of the basal area on each side.
- e. Where two primary mounds are installed without the down slope clearance for the two performance wells required pursuant to 13.E.1.d.2.
1. Two performance wells shall be installed at the toe of the basal area of each mound at proportionate locations from the mound centerline
 2. Two performance wells shall be installed on the down slope side of the lowest mound at ten feet down slope from the toe of the basal area of the mound at proportionate locations from the mound centerline.
 3. One performance well shall be installed five feet upslope from the edge of the upslope basal area of the upper mound.
2. Mound OWTS without supplemental treatment requires observation wells within the aggregate dispersal area per Figure 13.3b and Figure 13.3c.

13.4 At-Grade OWTS

- A. The At-Grade system accepts septic tank effluent and disperses the effluent evenly through pressurized perforated pipes in a gravel bed that is installed directly on top of ripped native soil. The effluent then percolates into the native soil. The system is covered with a loam or similar soil. Figure 13.4a is for illustration purposes only. Note that the diagram for the Shallow In-Ground would require the addition of an approved pretreatment unit to have a two-foot separation to the limiting condition.

Applicability: Areas of:

1. High groundwater;
2. Limited acceptable soil.

Figure 13.4a
SIG (requires pretreatment), At-Grade, Mound Soil Below Trench Bottom
Requirements

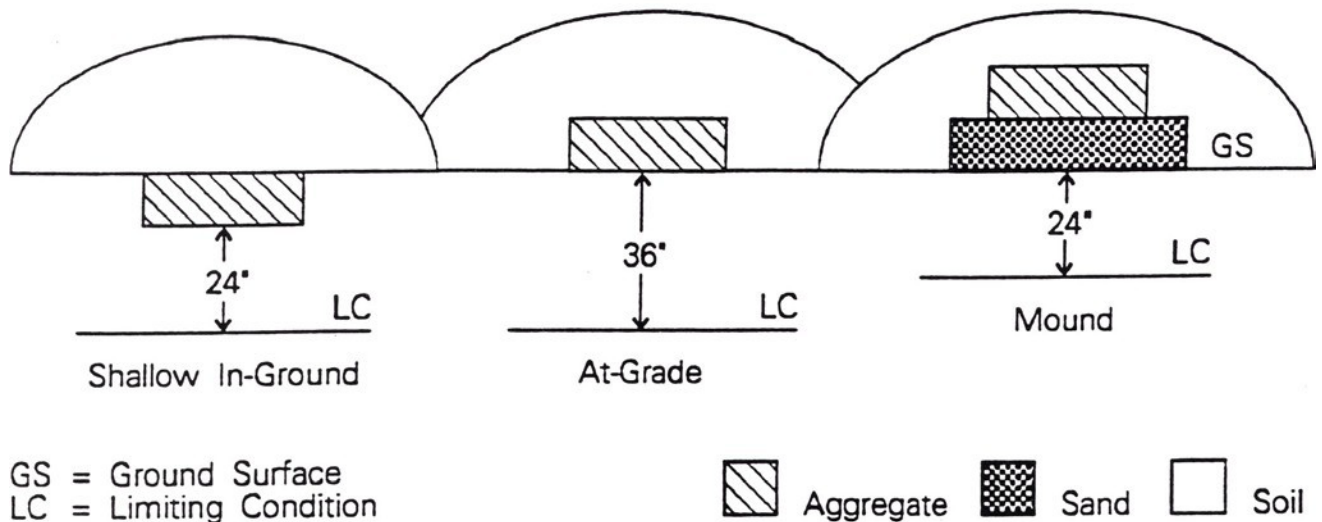

- B. The site criteria for At-grade OWTS includes the following:

1. Permeable soil is required to a depth of 36 inches.
2. Percolation testing done at 24 or 36 inches must meet the following criteria:
 - a. Percolation testing may also be required at 12 inches if the horizon appears more limited than the 24 and/or 36 inch horizons.
 - b. One to 120 minutes per inch for at-grade systems on slopes up to 25 percent. Note: A sand filter or other approved pretreatment unit is required when percolation rates are faster than five minutes per inch or slower than 90 minutes per inch.
 - c. Rates faster than one minute per inch are not acceptable.

3. Separation from native grade to the limiting condition is 36 inches but may be reduced to 24 inches with the use of a sand filter or other acceptable pretreatment unit.
4. Minimum separation is 36 inches from fractured rock, rock exceeding 50 percent by volume, or bedrock as measured from native grade. It may be reduced to 24 inches with the use of a sand filter or other approved pretreatment unit.
5. Avoid designing the system in an area of rock out-croppings, boulders and trees. When it is unavoidable due to having no other viable location for the system, the basal area will need to be increased to compensate for the reduced soil availability.
6. The separation distance between individual primary At-Grade systems shall be as follows:
 - a. The downslope distances shall be zero feet.
 - b. The side slope distances shall be four feet.
7. The separation distance between a primary At-Grade system and a reserve At-Grade system shall be as follows:
 - a. The downslope distances shall be zero feet.
 - b. The side slope distances shall be two feet.

Table 13.4 At-Grade Separation Distances

| Primary System to: | Downslope | Side Slope |
|--------------------|-----------|------------|
| Primary System | 0' | 4' |
| Reserve System | 0' | 2' |

8. The separation distances shall be measured from the following features:
 - a. Downslope separation distances shall be measured from the down slope edge of the primary at-grade's soil cover (toe of fill) to the upslope edge of the secondary or reserve at-grade's soil cover (toe of fill).
 - b. Side slope separation distances shall be measured from the ends of the aggregate beds of the primary at-grade to the end of the aggregate area of the secondary or reserve at-grade.
 9. The downslope separation distances may be reduced provided the design and site evaluation parameters demonstrate there is no horizontal movement of the effluent upon dispersal and that hydraulic mounding will not occur.
- C. The following design criteria shall be used for At-Grade OWTS in addition to the most current edition of the *Wisconsin At-Grade Component Using Pressure Distribution Manual for Private On-Site Wastewater Treatment Systems*.
1. Linear Loading Rate (LLR)
 - a. Designers shall estimate the LLR for all proposed At-Grade systems and shall design

the width dimensions and gravel dimensions accordingly, so that the distribution bed is long and narrow and on contour (Refer to Figure 13.4b).

- b. When the depth to a limiting condition (for example impermeable soil layer or rock) is only 36 inches (or 24 inches with pretreatment) the LLR shall not exceed 4 gallons per linear foot per day (refer to Table 13.3a and Figure 13.4a).
- c. If it can be demonstrated that the wastewater flow will be vertical as well as horizontal, a higher LLR may be proposed.

Figure 13.4b – At-Grade

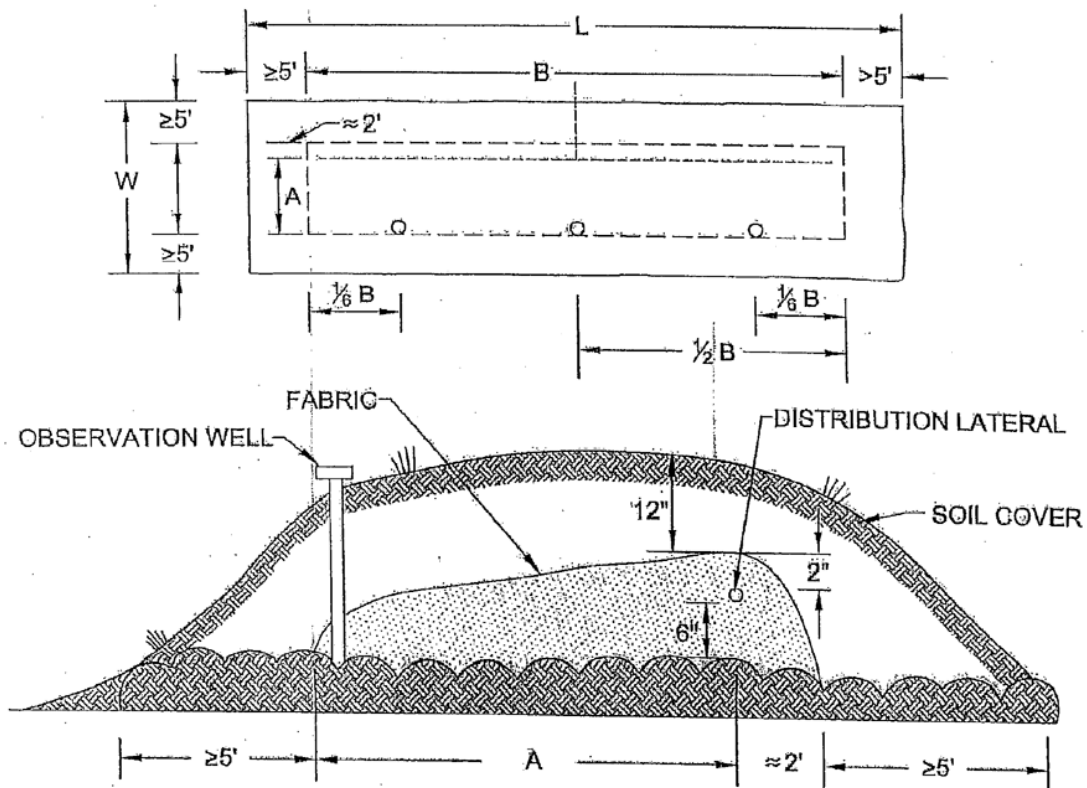

PLAN VIEW AND CROSS SECTION OF WISCONSIN AT-GRADE UNIT WITH A SINGLE ABSORPTION AREA ON A SLOPING SITE

2. Soil Loading Rate

The soil loading rate shall ~~is to~~ be based on the most restrictive soil horizon in contact with the distribution area. Use the percolation rate of the most restrictive soil horizon(s) and apply the corresponding Sewage Application Rate (SAR) from Table 7.2a.

1. Configuration (Refer to Figure 13.4b)

- a. The length of the gravel bed (B) shall be greater than or equal to the design wastewater flow divided by the LLR.
- b. The basal area shall be greater than or equal to the design wastewater flow divided by the SAR.
- c. The effective width of the gravel bed (A) shall be greater than or equal to the design wastewater flow divided by the basal area length (B). In no instance shall the width of the distribution bed below and downslope of the lateral exceed 15 feet.
- d. Absorption bed depth
 - i. There shall be a minimum of 6 inches of gravel below the distribution pipe for residential systems with 2 inches of gravel cover over the pipe.
 - ii. There shall be a minimum of 9 inches of gravel below the distribution pipe for commercial systems with 3 inches of gravel cover over the pipe.
- e. Dual Beds. Provided each at-grade is designed independently and meets the design criteria for individual at-grades, the valley space between the at-grade systems may be filled in with the appropriate cover material.
- f. The gravel bed shall extend at least two feet upslope of the uppermost distribution pipe lateral.

2. Aggregate

- a. Three eighths inch double washed pea gravel size to two inch double washed drain rock.
- b. The percentage of fines of washed gravel shall not exceed one percent by weight.

3. Natural Contour

- a. The distribution bed shall explicitly follow the natural contour of the ground. The bed must be installed within a tolerance of three inches vertically per 100 feet horizontally.
- b. Distribution beds shall be angled or curved to meet this requirement.
- c. The distribution bed shall not be placed in a concave landscape position.

4. Soil Cover

- a. A geo-textile synthetic fabric (Mirafi 140 N or equivalent) is to be placed over the aggregate bed.

- b. Twelve inches of soil covering is to be placed over the aggregate distribution cell and shall extend to the limits indicated on the plan. Additional depth of topsoil must be placed during the time of construction to assure that the minimum depth is achieved following natural settling of the soil.
- c. Soil cover shall extend a minimum of five feet uphill and on both sides of the gravel bed. Downslope soil cover shall conform to Table 13.3d.

5. Distribution System

- a. Total Dynamic Head Loss. Designers shall calculate the total dynamic head loss of the entire distribution system.
 - i. Vertical differences.
 - ii. Length of entire piping system.
 - iii. Loss of all valves, tees, elbows and appurtenances.
 - iv. Head loss shall be referenced in feet of elevation.
 - v. Distribution piping shall be Schedule 40 PVC or greater of at least ¾ inch diameter.
 - vi. Hydraulic orifice discharge shall be a minimum of 60 inches for upward discharge. Orifices shall have a protective shield.
 - vii. Orifice spacing shall be a maximum of 36 inches on center (closer spacing is preferred).
 - viii. Size of orifices shall be 1/8 to 3/16 of an inch.
- b. Balancing Valves and Purge Valves. System distribution manifolds shall have a balancing valve at the beginning of each pressurized line and a purge valve at the end.
 - i. All valves shall be protected and encased within plastic, concrete or other approved type box to provide easy access and maintenance. Metallic valves are prohibited.
 - ii. Box size shall be 10 inches across or larger, round or square, and must allow room for maintenance and/or to install standpipes onto the ends of the purge valves.
 - iii. Gate valves used as balancing valves shall be PVC Schedule 40 or higher. Ball valves used as purge valves shall be PVC Schedule 40 or higher.
- c. Perforated Pressurized Lines.
 - i. One or two pressurized lines may be used in the At-Grade bed with the goal to provide maximum distribution of wastewater along the length of the At-Grade. Where two lines are used, the distance between the lines shall be 24 inches.
 - ii. The maximum length of pressurized lines shall be 75 feet.
 - iii. The maximum distance between perforations shall be 36 inches. Where two pressurized lines are used the holes shall be staggered between the two lines.

iv. On sites with one percent slope or less, the pressurized lines shall be centered within the aggregate bed.

6. Sump and Pump.

Refer to Sections 8.4 and 8.5 for required sump and pump features. Note Automatic dosing siphons are NOT allowed in at-grade sewage dispersal systems.

7. Sizing calculations for at-grade systems.

Sizing calculations for at-grade dimensions shall be provided with all proposals.

D. The construction criteria for at-grade OWTS includes the following:

1. The use of wheel type vehicles is prohibited.

- a. For the purpose of ripping.
- b. When driving on any areas that have been ripped.
- c. When placing or moving the soil cover.
- d. At any time that the soil conditions are wet, moist, or saturated.

2. Placement of the pressurized transmission line from the sump tank to the at-grade manifold shall be a minimum of 24 inches below the surface of the ground.

3. Site preparation of soil surface to a depth of eight to 12 inches.

- a. Mow excessive vegetation.
- b. Cut and remove trees.
- c. Cut trees to ground level.
- d. Perform initial ripping parallel to the contours of the ground and only within the limits of the gravel base; rippers set eight to 10 inches apart. The interface of the native soil and the at-grade soil shall be ripped after the gravel has been placed and just prior to placement of the at-grade soil cover.
- e. Prohibit all traffic on any ripped surfaces until the full depth of gravel bed or cover material has been placed.

4. Gravel Bed:

- a. Temporary form boards are required to hold aggregate in place to construct the gravel bed.
- b. The temporary form boards shall be removed prior to placement of the soil cover.
- c. Place performance wells as specified in Section 13.4E.
- d. Place aggregate in the designated tilled area to the appropriate depth as specified in D.2 above.

- e. Work from the upslope side and avoid compaction along the downslope side.
5. Construct distribution network prior to cover placement.
 6. Perform hydraulic test after the distribution system has been completed.
 - a. Pump must be adequate to provide hydraulic orifice discharge of a minimum of 60 inches upward discharge. Orifices shall have a protective shield.
 - b. Distribution to all laterals shall be equal.
 - c. The test shall be inspected by the consultant and the Permit Authority.
 7. Place soil cover:
 - a. Place two inches (residential) or three inches (commercial) aggregate over the distribution network.
 - b. Place geo-textile fabric over the aggregate. Extend only to the edge of the aggregate.
 - c. Condition soil cover with sufficient moisture to allow track rolling to a firm cohesive surface.
 - d. Rip area to be covered with cover soil.
 - e. Place soil against the form boards and the entire gravel bed by track rolling. Remove the form boards.
 - f. Place soil over entire gravel bed by track rolling and grooming by hand.
 - g. On sites sloped greater than one percent, prevent surface runoff from adversely affecting the OWTS. Two options include an upslope surface intercept or grading to redirect the surface runoff.
 8. Establish the final grade of the at-grade by track rolling and grooming by hand. Apply erosion control measures before final inspection. Seed and mulch.
 9. Install performance wells and details as shown on the plans.

E. The performance well criteria for At-Grade OWTS include the following:

1. At-Grade OWTS with supplement treatment requires a minimum of five performance wells within and around the system.
 - a. On sites greater than one percent slope, one performance well shall be installed five feet upslope from the upslope edge of the gravel bed at the system centerline. The well depth shall be 36 inches below original grade. If the system was designed for 24 inches of soil and utilizing a pretreatment unit, the well depths shall be 24 inches below original grade.
 - b. On sites greater than one percent slope, two performance wells shall be installed ten feet down slope of the gravel toe at proportionate locations from the centerline. The well depths shall be 36 inches below original grade. If the system was designed for 24 inches of soil and utilizing a pretreatment unit, the well depths shall be 24 inches below original grade.

- c. On sites greater than one percent slope, two performance wells shall be installed at the down slope toe of the gravel bed at proportionate locations from centerline at a depth of 24 inches. The depth of these performance wells shall extend to the gravel soil interface. The slotted/screen casing of the well shall extend through the entire depth of the gravel. Gravel (instead of sand) shall be placed in the annulus between the casing and the borehole. For long systems, at least one performance well shall be installed in each 75 feet of lateral. See Section 11.6.
 - d. On sites with a one percent slope or less, two performance wells will be required on each side of the system installed 10 feet from the gravel toe at proportionate locations from centerline. The well depths shall be 36 inches below original grade or 24 inches below original grade if a pretreatment unit was utilized.
2. At-Grade OWTS without supplemental treatment requires observation wells per figure 13.4b.
- a. For sites less than one percent slope, one of the observation wells shall be on opposite side of the aggregate bed.
 - b. For sites greater than one percent slope, the observation wells shall be on the downslope side of the aggregate bed.

13.5 Shallow In Ground (SIG) OWTS

- A. Shallow In-Ground Systems (SIG) disperse effluent via pressurized perforated pipes in shallow depth trenches which are covered by fill material.
- 1. SIG systems are designed with the acceptable fill material as soil cover.
 - 2. The fill or soil cover shall be placed in accordance with the standards for Filled Land systems.

Applicability:

Areas of shallow top soils over slowly permeable or fractured subsoils.

- B. The site criteria for SIG OWTS includes the following:
- 1. Percolation rate of one to 120 minutes per inch for systems.
 - 2. Percolation rates faster than one minute per inch are unacceptable.
 - 3. Percolation tests shall be at trench depth and at two and three feet below the trench depth, if necessary after soil profile review.
 - 4. Visual field observations and soil texturing to identify any limiting conditions.
 - 5. Sizing of dispersal system shall be based on both soil morphology and the percolation rate at the most restrictive horizon.
 - 6. Systems shall have a minimum separation of 36 inches to groundwater, fractured or impermeable soils beneath trench bottom. Note that minimum separation may be reduced to 24 inches below trench bottom if an approved supplemental treatment unit is used.

7. Soil structure and texture above the trench is extremely important to maximize system function. As such SIG systems may not be installed below non-permeable type soils such as high shrink well clays, highly compacted soils, highly cemented soils, and/or massive or platy soil structures, without the addition of an approved supplemental unit.
 8. See Sections 12.1 and 12.2 and Table 7.2c for restrictions on use and other required setbacks.
 9. Soil cover of 12 inches minimum is required.
- C. The design criteria for SIG OWTS shall be the same as the design criteria as the Mound System as outlined in Section 13.3C.
1. Refer also to the Permit Authority regulations for Filled Land Systems.
 2. Trench Spacing:
 - a. Minimum of 8 feet on center for 0 to 12 ½ percent slope.
 - b. Minimum of 10 feet on center for 12 ½ to 25 percent slope.
 3. Approved supplemental treatment units are required on sites with percolation rates faster than five or slower than 90 minutes per inch.
 4. A dual system with an approved diversion valve shall be designed and installed for SIG systems.
- D. The construction criteria for the ISF OWTS includes the following:
1. See Section 9.5.A.15 for fill placement and Section 9.7.E for trench construction and pressure line installation.
- E. The performance well criteria for SIG OWTS shall be the same as outlined in Section 13.3.E.

13.6 Drip Dispersal OWTS

- A. A drip dispersal OWTS is a pressurized wastewater distribution system that delivers precise doses of effluent to shallow subsurface dispersal/reuse fields. Prior to dispersal, the effluent shall be pretreated by a supplemental treatment unit. The distribution piping is small diameter flexible polyethylene tubing (dripline) with in-line emitters that discharge effluent at slow controlled rates.

A typical drip dispersal system installation includes a septic tank, supplemental treatment, a dosing chamber, pump(s), control panel, timed dosing and supply and return flow metering, particulate filter, filter backwashing and drip line flushing, driplines, and performance wells. A supplemental treatment unit that reduces effluent strength as described in Section 13.9 Pretreatment Units is required.

Applicability: Areas of:

1. High groundwater;
2. Shallow soil over fractured rock or coarse alluvium;
3. Shallow soil over impermeable soil or bedrock;

4. Steep slopes;
5. Slow percolation at standard leachline depths;
6. Rapid percolation at standard leachline depths;
7. Tree preservation.

B. The site criteria for drip dispersal OWTS includes the following:

1. Depth to a limiting condition and permeable soils below the drip line bottom shall be a minimum of 24 inches. Percolation testing shall be conducted 24 inches below drip tubing depth. Percolation testing shall be required if shallower soil horizons are expected to have a slower percolation rate as determined during the soil evaluation. Acceptable percolation rates shall be between one to 120 minutes per inch, except as provided in section 13.7.C.16 for disinfection of treated effluent.
2. The soil above the drip line proposed depth shall be permeable. This excludes massive or platy structured soils. Soils subject to flooding, excessive irrigation, farming practices, grading, ripping or roto-tilling are also not acceptable. The quality of acceptable soils above the dripline shall be equal to those below the dripline.
3. A minimum of 24 inches of permeable soil below emitter depth shall extend a horizontal distance of no less than 25 feet down gradient from the edge of the dispersal field, including expansion areas.
4. A geotechnical study is required for drip irrigation systems on sites where fill material is placed over the drip system as part of the soil cover requirement.
5. Fill material shall be classified as a Zone 2 soil as per Figure 7.4 as determined by hand texturing or provided quarry specifications and rocks no greater than two inches and approved by Qualified Consultant prior to placement.
6. Setback requirements shall be measured from the perimeter of the drip line to feature being setback from

C. The design criteria for drip dispersal OWTS includes the following:

1. Separation between emitter line laterals shall be a minimum of two feet.
2. Dripline emitters shall be spaced 12 - 24 inches apart.
3. A drip system is typically installed 12 inches into native soil with 12 inches of native backfill. The minimum native soil cover is six inches. Additional soil cover can be provided with appropriate fill material. The maximum soil cover allowed is 18 inches. (See Figure 13.7a).
4. An "at-grade" drip system may be installed at the pre-existing grade if a minimum of 24 inches of acceptable soil to limiting conditions and permeable soils is met pursuant to the site criteria listed in B.
 - If the drip line is proposed to be placed at native grade, fill material (native or imported soil) is first placed as cover material above grade. A small trench is constructed in the fill and the dispersal tubing is placed within the trench with native material and/or imported fill backfilling the trench.
 - The dispersal piping or tubing shall be installed at the pre-existing grade or below.

- A minimum depth of six inches of approved soil cover is required to be placed on the dispersal piping or tubing. Additional soil cover can be provided with appropriate fill material. There shall be six to 18 inches of soil cover over the drip lines.

Figure 13.6a – Drip Trench Cross-Section

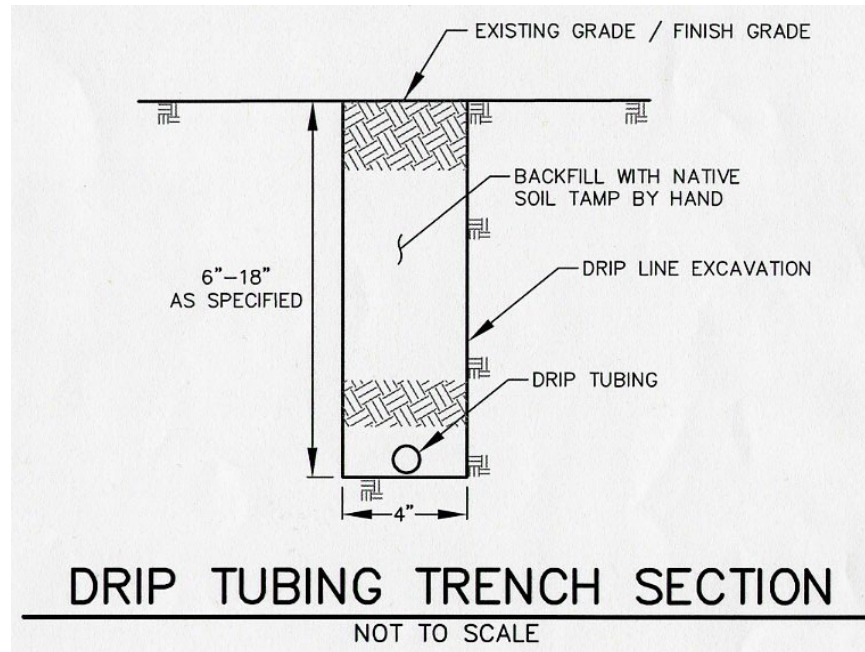

5. Soil application rates generally assume each emitter will wet an area of four square feet. However, this assumption is not valid in all soil types because the size of the wetted volume depends on soil characteristics and dosing cycles. Sizing of the drip dispersal system shall be based on both soil morphology and the percolation rate at the soil horizon with the lowest effluent application rate (See Table 7.2a for percolation rates or 7.2b for soil morphology). Designers shall clearly demonstrate the minimal square footage required as determined by the soil morphology and percolation rate. Percolation tests may be waived for developed parcels in some circumstances. When soil morphology results in differing effluent application rates than the percolation test data, priority shall be given to the percolation test data.
6. The designer shall also determine the number of zones, the number of doses, the quantity of the dose, the head losses, spacing of drip lines, spacing of drip emitters, diameter of the drip tubing (typically 0.55 inches), pump size, location of air relief valves and the “frequency of flushes.”
7. Distribution zones shall be designed to be consistent with dripline manufacturer requirements. The length of each distribution line shall not exceed manufacturer’s specifications to ensure equal distribution to each emitter. Measures shall be employed to prevent uneven distribution of the dispersal field including maintaining uniform line lengths. If multiple zones are designed, dosing shall be automatically alternated between each zone.
8. All drip dispersal systems require an approved supplemental treatment unit for treating septic effluent and mechanical filtration with Vortex/Spin Filter(s) or Disk Filter(s). The supplemental

treatment unit shall comply with NSF Standard 40 or the approval of the Permit Authority, with Section 13.7 Supplemental Treatment Units. Different drip dispersal products may require different levels of supplemental treatment.

9. Drip systems are “closed loop” networks with control valves and supply/return manifolds to allow for periodic line flushing (See Figure 13.6b). Required flushing velocity shall be a minimum of one foot per second.

Figure 13.6b – Example Single Zone Schematic

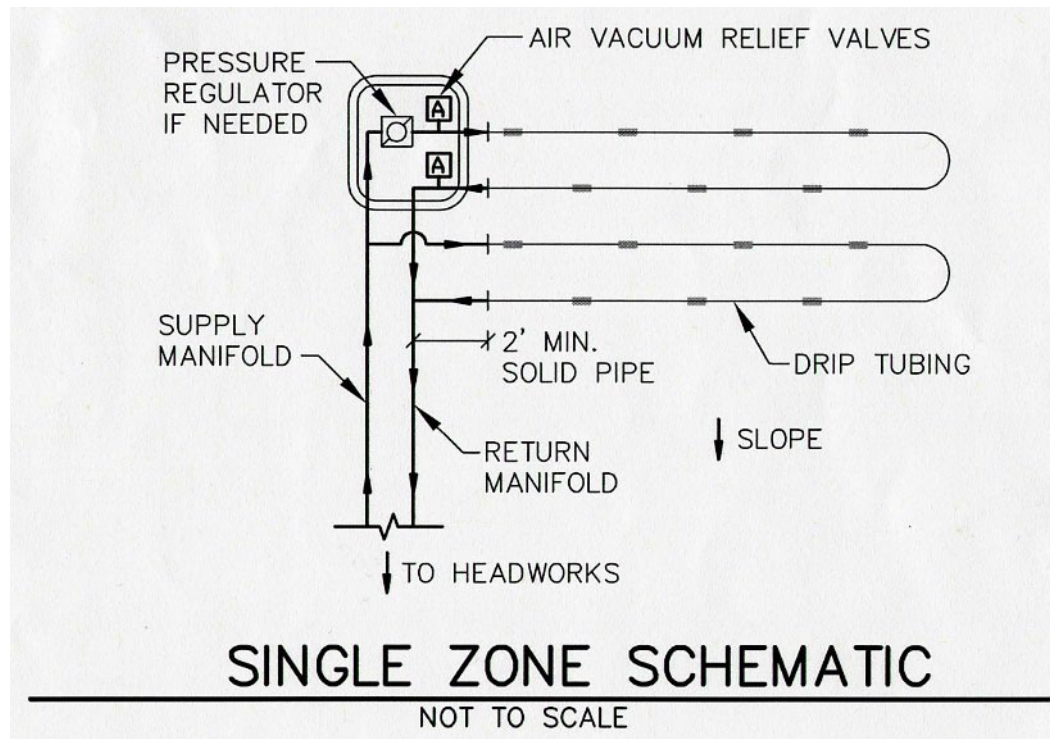

10. Designer shall employ measures to prevent uneven distribution of the dispersal field due to drain down following a pump cycle. Per California Plumbing Code (CPC), spring check valves are not allowed for wastewater applications. See Figure 13.6c for an example of a top feed manifold.
11. Provide two feet of solid tubing/pipe between the manifold and the drip tubing (See Figure 13.6d).
12. Air/vacuum release helps prevent soil particles from being sucked into emitters and is required on all drip systems. Air/vacuum release valves shall be installed at the high point of each distribution sector of the supply and return manifold. The air relief valves shall be equipped with Schrader valves in order to check pressure. These valves shall be located in valve boxes with adequate room to attach a pressure gauge (See Figure 13.6e).

Figure 13.6c – Example Top Feed Manifold

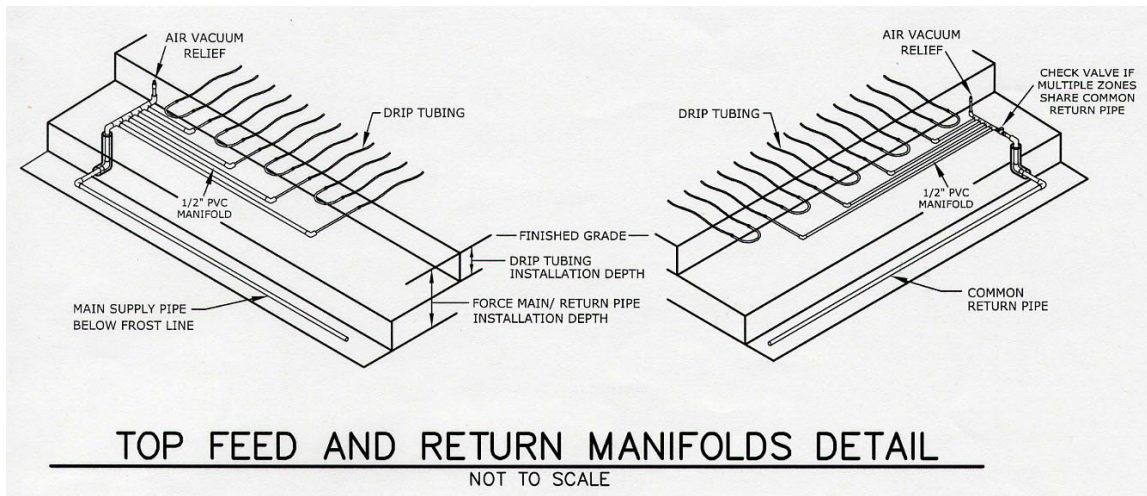

Figure 13.6d Example Manifold Connection

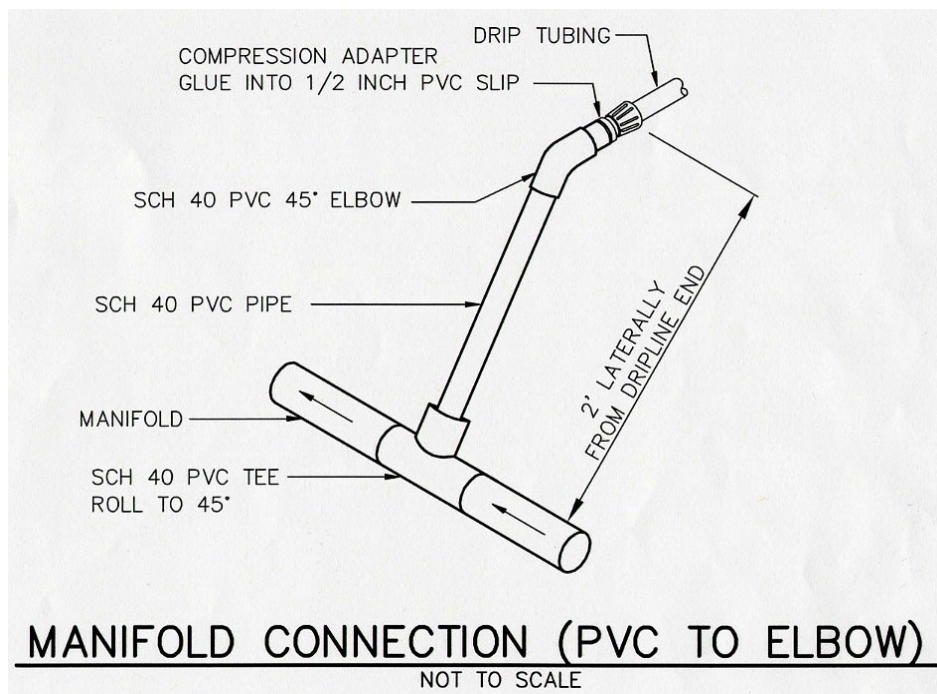

Figure 13.6e – Example Air Relief with Schrader Valve

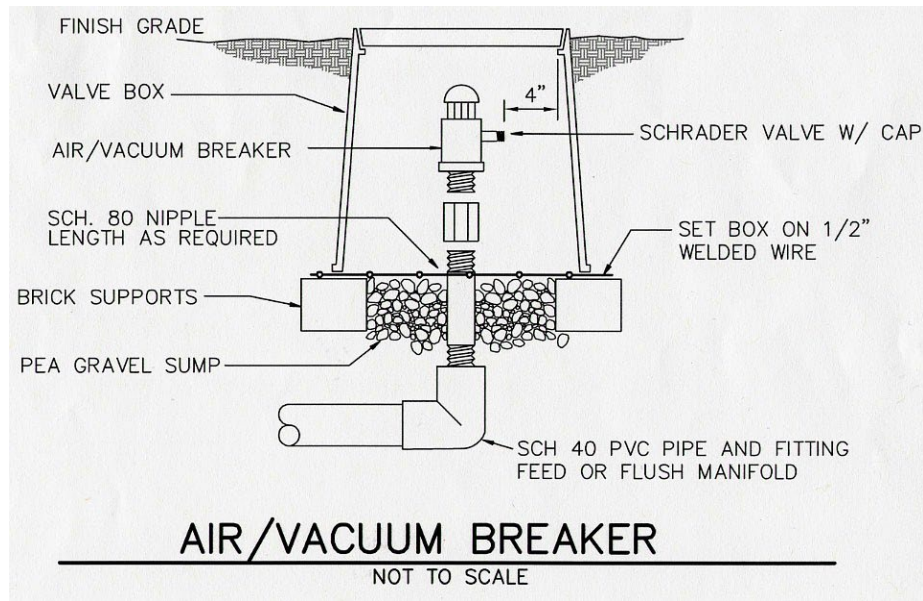
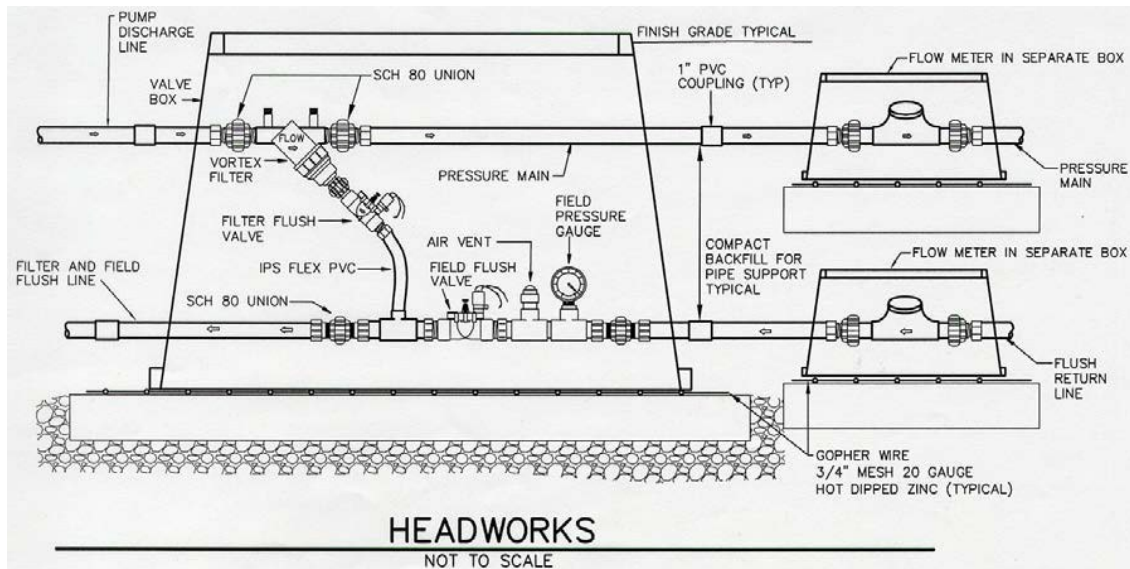
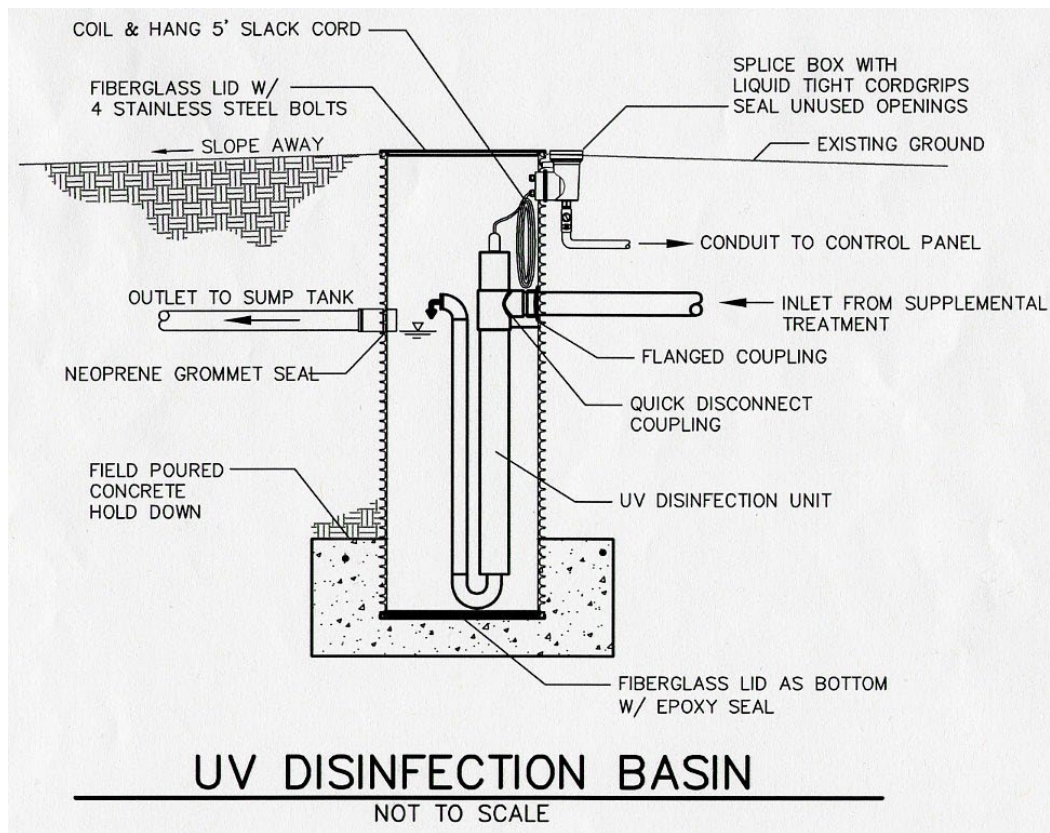

Figure 13.6f – Example Headworks



13. All system components (filters, control valves, air vacuum relief valves, pressure regulators and controllers) shall be appropriately sized for the system dosing and flushing flow rates and shall meet specifications of the drip line manufacturer (See Figure 13.7f for example of headworks). All transport piping, supply and return manifolds and fittings shall be Schedule 40 PVC or Schedule 80 PVC if threaded fittings are utilized. All filters shall be sized to operate at a flow rate greater than or equal to the maximum design discharge rate of the system including the field flush cycle.
 14. Filter backwash and drip field flushing debris shall be returned to the septic tank or to the sump chamber.
 15. Totalizing flow meters (in gallons) are required on the supply and return distribution lines. Flow meters shall be installed in a readily accessible location for reading and servicing.
 16. A controller capable of timed dosing and automatic line/filter flushing is required.
 17. Disinfection of the treated wastewater shall be incorporated into drip irrigation systems in the following cases (see Figure 13.6g):
 - a. The soils are well-drained soils (less than one minute per inch or faster).
 - b. The soil cover, native or fill material, is between six and 12 inches in depth.
- D. The construction criteria for drip dispersal OWTS includes the following:
1. Dripline can be trenched (by hand or with a trenching machine) into narrow, shallow trenches or plowed directly into the soil (with a vibratory plow or other insertion tool) and backfilled without gravel or geotextile. Trenching shall occur after fill placement is complete if fill is utilized in the drip dispersal area.
 2. Systems should be designed for the dripline lateral to follow the contour and as specified by the manufacturer's specifications. -Whenever drip lines cannot follow the contour, distribution network driplines with Pressure Compensating (PC) emitters shall be installed.
 3. Valves shall be readily accessible for service and/or inspection. All valve boxes shall be protected from gopher soil movement. A detail of the valve box shall be included on the plans. Specify concrete, hardware wire or similar bottom.
 4. A ground cover (turf, fruit trees or other appropriate landscaping) or native vegetation shall be planted over the drip field after installation to provide additional treatment, prevent erosion and increase wastewater reuse through plant evapotranspiration.
 5. Fill material may only be placed above native soil to augment soil cover and shall not be used to meet required soil depth minimums.

Figure 13.6g – Example Disinfection Unit



6. The system designer shall describe the type of fill to be placed in terms of texture and structure, the depth, and method of ripping before placement. Fill shall be installed prior to the installation of the drip tubing. Contractor shall employ methods ensuring that the fill is uniform in depth. Drip tubing shall be installed through the fill to the designed depth per D.1 above.
7. Site preparation shall include the following:
 - a. Vegetation is to be removed and the surface prepared prior to fill placement to permit good mixing of the native soil and fill material.
 - b. Cut and remove trees.
 - c. Grind stumps ground level or to a maximum depth of 12 inches below grade.
 - d. Areas with closely spaced trees that may directly impact the drip tubing shall be shown on the site plan with an appropriate protection zone between the drip tubing and large root system.
 - e. A minimum two foot setback to vineyard stalks shall be utilized.
 - f. All trees to remain and to be removed shall be shown on the plan.
 - g. Rototilling to prepare the site for fill is prohibited.
8. Fill placement shall include the following:

- a. Place initial six inches of fill. Fill material for drip systems shall be placed in lifts not exceeding six-inch layers at approximately the same relative compaction as the upper native soil horizon.
 - b. The fill is to be of uniform depth extending to a distance at least five feet downslope and two feet up slope/laterally from the center of any drip line.
 - c. The fill slope toes shall be tapered at a five to one ratio minimum.
 - d. Following the initial six inches fill layer placement, soils shall be ripped.
 - e. A single pass rip at 12 inch depth shall be performed to incorporate the initial fill layer depth plus six inches into native to integrate fill material and native soil. Tines to be spaced approximately eight to 10 inches apart. Ripping shall be parallel to the topographic contours.
 - f. The fill material should be applied in shallow layers to prevent an abrupt textural interface. Placement of fill should be uniform so preferential bypass flows do not occur. Soil should not be compacted due to fill placement activities. No wheeled vehicles shall enter the fill area.
 - g. Remaining fill material (if applicable) to be placed after the initial ripping occurs.
 - h. Wheeled tractors are ~~to be~~ prohibited in the dispersal area at this time to avoid soil compaction.
9. Landowners shall not conduct activities that damage the drip tubing or compact the soil.
- E. The performance well criteria for drip dispersal OWTS includes the following:
- 1. A minimum of four performance wells shall be installed around the drip dispersal field.
 - a. One performance well shall be located 10 feet upslope of the system to a minimum depth of 24 inches below the drip line depths.
 - b. One or more performance wells shall be located 10 feet down slope of the system to a minimum depth of 24 inches below the drip line depths.
 - c. Two performance wells shall be located 25 feet down slope of the system to a minimum depth of 24 inches below the drip line depths. See Figure 11.6.

13.7 Supplemental Treatment Units

- A. Supplemental treatment units are used in conjunction with OWTS voluntarily or to augment a lack of separation to a limiting condition. In cases where supplemental treatment is used, the Permit Authority and the RWQCB may allow two feet as the minimum depth of acceptable native soil to a limiting condition.
- B. For aerobic treatment unit (ATU) systems that function with external blowers, a cutoff switch or interlock that disables the pump shall be built into the control panel so the discharge pump will not function if the blower is turned off.
- C. Recirculating sand filters, single pass intermittent sand filters and bottomless sand filters are

approved supplemental treatment units. Sand filtration may be defined as the intermittent application of wastewater to a bed of granular material that has an under drain to collect and discharge the final effluent. The purpose of sand filters is to pretreat the effluent and improve wastewater quality.

- D. The design of sand filters in Sonoma County is based on the “*Guidelines for the Use of Sand Filters*” (Technical Review Committee, August 2, 1989. Washington State Department of Health, Olympia, Washington). Qualified consultants may propose to the Permit Authority, the use of sand filters to justify increasing soil application rate.
- E. The State OWTS Policy Tier 3 in Section 20.1 addresses supplemental treatment units for OWTS within an TMDL area or subject to an Advanced Protection Management Program.
- F. OWTS that use a supplemental treatment unit for compliance are subject to the operational permit program and monitoring. Performance wells are required for non-standard systems in the monitoring program. See section 11.5.

Section 14 OWTS Operational Permit and Monitoring

- A. Pursuant the State OWTS Policy, all OWTS systems that are required to have a supplemental treatment unit or that meet application criteria of Sections 12 (Experimental) are required to obtain a of valid operational permits (OPR)pursuant to Sonoma County Code Sections 24-33 and 34.
 - 1. Operational permit applications shall be filed with the Permit Authority on the appropriate county application form. Each OPR application shall include all required fees and deposits, all plans and specifications, maps, reports, and other information and materials required by the Permit Authority pursuant to the Permit Authority’s policies. Other information and material the Permit Authority deems necessary to verify compliance with this OWTS Manual shall also be submitted. All documents shall be submitted prior to final OWTS approval.
 - 2. Operational permits are transferable subject to an ownership transfer fee.
 - 3. If a property changes ownership within 60 days of the issuance of the original operational permit, the permit may be transferred without additional fees. The anniversary date shall remain as per permit originally issued.
 - 4. The property owner is responsible for compliance with all aspects of the operating permit requirements.
- B. A recorded OPR easement agreement is required for all OWTS subject to this Section. The purpose of easement agreements is to allow Permit Sonoma staff and associates, and/or the RWQCB onto the properties to monitor and test the OWTS with supplemental treatment.
 - 1. A separate OPR easement agreement is required whenever a portion of the OWTS with supplemental treatment is located on a different parcel.
 - 2. OPR easement agreements may not be removed from the title of the property unless authorized inwriting by the Permit Authority.
 - 3. Failure to provide access to the OWTS and/or components for inspection and monitoring when requests for access have been communicated to the property owner is cause for enforcement action.
- C. Monitoring forms will be provided by Permit Authority staff to the property owner two times per year for recording information regarding the OWTS operation.
 - 1. Property owners shall complete the monitoring reports and submit them to the Permit Authority within 30 days of receipt.
 - 2. Failure to perform the self-monitoring and submit reports to the Permit Authority shall be cause for enforcement action.
- D. All Experimental and OWTS with a supplemental treatment unit, and/or TCOM/VCOM panels, are required to to be maintained and monitored Qualified Service Provider for the life of the system.
- E. OWTS with a supplement treatment unit and which have standards for performance wells within the respective OWTS section shall comply with those performance well standards. OWTS without a supplement treatment unit are not subject to the respective performance well standards, except for mounds and at-grade OWTS. Mounds and At-Grade OWTS without supplemental treatment units are subject to the performance well standards contained in the Wisconsin Mound Manual and the Wisconsin At-Grade Manual, respectively.

- F. For OTWS in the OPR Program, the Permit Authority may occasionally sample performance wells for total coliform bacteria, fecalcoliform bacteria, and nitrates as indicators of the degree of sewage treatment and function of OWTS with supplemental treatment. See Section 5.3.

Section 15 Vesting Certificates

15.1 General

- A. Purpose: The purpose of a Vesting Certificate is to protect the certificate holder from subsequent changes in OWTS regulations, thereby providing some degree of certainty for a limited period of time pursuant to Sonoma County Code Chapter 24. Vesting Certificates are transferable and run with the land.
- B. Eligibility for filing or withdrawing a Vesting Certificate Application: A Vesting Certificate application shall only be filed or withdrawn by the property owner or easement holder of the site, an authorized agent of the property owner or easement holder, or other person with the written consent of the property owner or easement holder.
- ~~C.~~ Vesting Certificate application requirements: Vesting Certificate applications shall be filed pursuant to the Permit Authority's policies.
- D. Issuance of Vesting Certificates: Prior to issuance of a Vesting Certificate, the Permit Authority shall perform a site evaluation which may be completed as part of the OWTS Application process. Vesting Certificates shall only be issued to the property owner or easement holder of the site. The Permit Authority shall provide a certified copy of the vesting certificate to the property owner or easement holder of the site so that the property owner or easement holder may record the document if desired. The issuance of a Vesting Certificate is solely a right to construct an OWTS. It does not obligate the county to issue any other permit and does not mean or imply any other land use entitlement or construction approval.
- E. Expiration of a Vesting Certificate: A Vesting Certificate that exceeds the term for which it was issued shall expire by limitation without any further action by the Permit Authority. A Vesting Certificate shall also expire when an OWTS permit is issued for the OWTS authorized by the same Vesting Certificate.
 - 1. Vesting Certificates shall not be renewed.
 - 2. An applicant may file for a new Vesting Certificate in compliance with Section 15.1.C.
 - 3. Any new Vesting Certificate application for an OWTS design shall be succeeded by a new OWTS Application in compliance with Section 4.9. The new OWTS Application shall be processed based on the OWTS regulations in effect at the time the new OWTS Application is submitted.
- F. Conflicts with well permits: The Permit Authority cannot deny a permit for a well within 100 feet of a vested area unless an OWTS permit has been issued for the OWTS, authorized by a Vesting Certificate. Otherwise, the well permit may be issued by the Permit Authority and the Vesting Certificate may be subject to revocation in accordance with Section 15.4.A.3.

15.2 Term Limitations

- A. Term of Vesting Certificates for approved OWTS designs: Vesting Certificates for approved OWTS designs are valid for three years from the date the vesting certificate is issued. The Vesting Certificate shall only be valid for the approved OWTS site, designated OWTS type, and stated capacity. Upon submission of a complete OWTS permit application within the term of the Vesting Certificate, an OWTS permit shall be issued in accordance with the approved plans. Prior to OWTS permit issuance, a site evaluation shall be performed to determine that no changes have occurred which may cause revocation of the Vesting Certificate.
- B. Term of Vesting Certificates for constructed OWTS: Vesting Certificates for constructed OWTS are valid for two years from the date the OWTS permit is finalized. A Vesting Certificate for a

constructed OWTS shall guarantee septic approval of a building permit for a structure connected to the constructed OWTS provided all the following conditions apply:

1. A complete building permit application is submitted within the term of the Vesting Certificate.
2. The proposed structure does not exceed the capacity of the constructed OWTS.
3. The proposed structure does not conflict with required setbacks to any feature of the constructed OWTS.

15.3 Prohibitions

- A. Experimental OWTS are not eligible for Vesting Certificates.
- B. OWTS subject to Waste Discharge Requirements (WDRs) from the RWQCB are not eligible for Vesting Certificates unless the WDR's are specifically waived in writing by the RWQCB.

15.4 Revocation

- A. Vesting Certificates may be revoked by written notice from the Permit Authority in the following cases:
 1. The Vesting Certificate application or its issuance was ~~been~~ based upon false or erroneous data.
 2. Excavation, grading, or compaction of soils has occurred which affect the soil depth, ground slopes, or percolation rate, whether on the subject or adjoining parcels, and would render the approved dispersal system area or reserve replacement area unsuitable for an OWTS.
 3. Construction or alteration of wells, water impoundments, water channels, drainage facilities, roads, cuts or fills has occurred, whether on the subject or adjoining parcels, within the setbacks ~~that were~~ that were established by the OWTS regulations in in effect at the time of the OWTS Application, for which the Vesting Certificate was issued, was submitted to the Permit Authority.
 4. The Director of the Permit Authority determines a necessity to protect public health and safety and/or to prevent a significant adverse impact on the environment.
 5. The RWQCB adopts an area wide prohibition of waste discharges or a prohibition of specific types of discharges.
- B. Vesting Certificate revocations may be appealed pursuant to Sonoma CountyCode Section 24-57.

Section 16 Land Use Entitlement Projects

- A. Land use entitlement projects are subject to applicable provisions of Sonoma County Municipal Code including but not limited to Chapters 25 (Subdivisions) and 26 (Sonoma County Zoning Regulations).
- B. Existing and proposed wastewater disposal conditions shall be evaluated for compliance with Sonoma County Municipal Code and this OWTS Manual. Septic feasibility reports pursuant to the Permit Authority's policies may be used to satisfy this requirement.
- C. The Permit Authority shall establish appropriate conditions of approval for land use entitlement projects.

Section 17 Variance Requirements

17.1 Variance Requirements

- A. Requests for variances of State and/or County regulations may be granted only when the Director of the Permit Authority, or his/her designee, determines that the requested variance is consistent with the minimum standards for public health and water quality protection. Any variance request must provide a corresponding mitigation measure(s) or justification to assure that public health and water quality protection at least equal to that established by the rules, is provided.
- B. Variances cannot be approved for the prohibitions listed in Section 4.6.B unless there is a corresponding mitigation measure listed in Section 4.7.
- C. Variance Justification. The variance justification shall include the following:
 - 1. The special circumstances affecting the property that make the strict application of the standards impractical,
 - 2. The standard proposed to be varied,
 - 3. The proposed substitute measure and when it would apply,
 - 4. How the mitigation measure achieves the same intent or goal as the standard being varied,
 - 5. The soil type, according to the USDA Sonoma County Soil Survey,
 - 6. Soil profile logs,
 - 7. Depth to groundwater,
 - 8. Preliminary OWTS design.
- D. Variance requests for undeveloped parcels and upgrades to existing OWTS that would result in a potential increase in flow are prohibited in areas identified in Section 18.

Section 18 Variance Prohibition and Special Standards Areas

- A. There are several areas in Sonoma County that are subject to variance prohibitions and/or special standard requirements. These areas include the following:
1. Camp Meeker
 - a. Variance requests for new construction of structures on vacant lots and construction on existing structures that would result in an increase of flow prohibited.
 - b. All applications approved by Permit Authority are subject to a condition that the structures involved will be connected to a community system when it becomes available.
 2. Canon Manor Subdivision
 - a. Permits/clearances for new construction of structures on vacant lots and/or construction on existing structures on OWTS that would result in an increase of flow prohibited.
 3. Coastal Subdivisions of Carmet, Rancho del Paradiso, Salmon Creek, Sereno del Mar and the Community of Jenner
 - a. Variance requests for new construction of structures on vacant lots and construction on existing structures that would result in an increase of flow prohibited.
 4. Happy Acres Subdivision
 - a. Lots of less than 30,000 square feet are unbuildable unless connected to the Happy Acres Water System.
 - b. All standard OWTS with intercept drains shall be designed by a Qualified Consultant.
 - c. If wet weather percolation testing required, no variances allowed.
 5. Larkfield-Wikiup Area
 - a. Septic system prohibition area Mayfield Drive, Ascot Drive, Fairly Drive, Eton Court, and Devon Court.
 6. Monte Rio
 - a. Variance requests for new construction of structures on vacant lots and construction on existing structures that would result in an increase of flow prohibited.
 7. Penngrove/South Cotati
 - a. Variance requests of wet weather percolation requirements prohibited.
 8. West Petaluma Area
 - a. All lots subject to 7.5 and 7.10 wet weather percolation testing and groundwater determination requirements.
 - b. An interceptor drain shall be provided on all lots that have not had wet weather groundwater determinations (for example, lots with a slope of greater than 5 percent).

- c. Lack of a confining layer in which to bed an interceptor drain will result in the need for wet weather groundwater determinations.
- d. Areas which exhibit spring activity or potential wintertime seepage shall be subject to wet weather groundwater determinations.

9. Russian River Meadows Subdivision Units 1 and 2 (also known as Rein's Beach)

- a. Wet weather testing may be conducted when observed water levels range from 0 to 12 inches below ground surface in the groundwater monitoring wells located on Assessor's Parcel Number 096-211-017 (22800 Conifer).
- b. Except for the above noted provision, variance requests for new construction of structures on vacant lots and construction on existing structures that would result in an increase of flow prohibited.

10. South Wright Area

- a. Variance requests for new construction of structures on vacant lots and construction on existing structures that would result in an increase of flow prohibited.
- b. No permits and/or clearances for property improvement, land division or change in use in the "septic tank ban area" shall be granted unless connection to sewer is included in the proposed application.

11. Thomas Larkin Woods Subdivision Unit 1

- a. Variance requests for new construction of structures on vacant lots and construction on existing structures that would result in an increase of flow prohibited.

12. Westvue Meadows Subdivision

- a. Compliance with depth to groundwater requirements (without variance), required on all lots, regardless of slope.

- B. The Russian River watershed has several water bodies that are listed as impaired pursuant to the Clean Water Act section 303(d). The identified reaches are subject to the Advanced Protection Management Program in section 19.1.
- C. The Petaluma River is subject to the approved 2020 TMDL for Bacteria in the Petaluma River Watershed and the APMP in OWTS Manual section 19.2.
- D. Sonoma Creek is subject to the approved 2010 Pathogen TMDL Implementation Plan and the APMP in OWTS Manual section 19.3.
- E. Refer to Maps 18.1-12 for areas subject to this Section.

Map 18.1 Camp Meeker

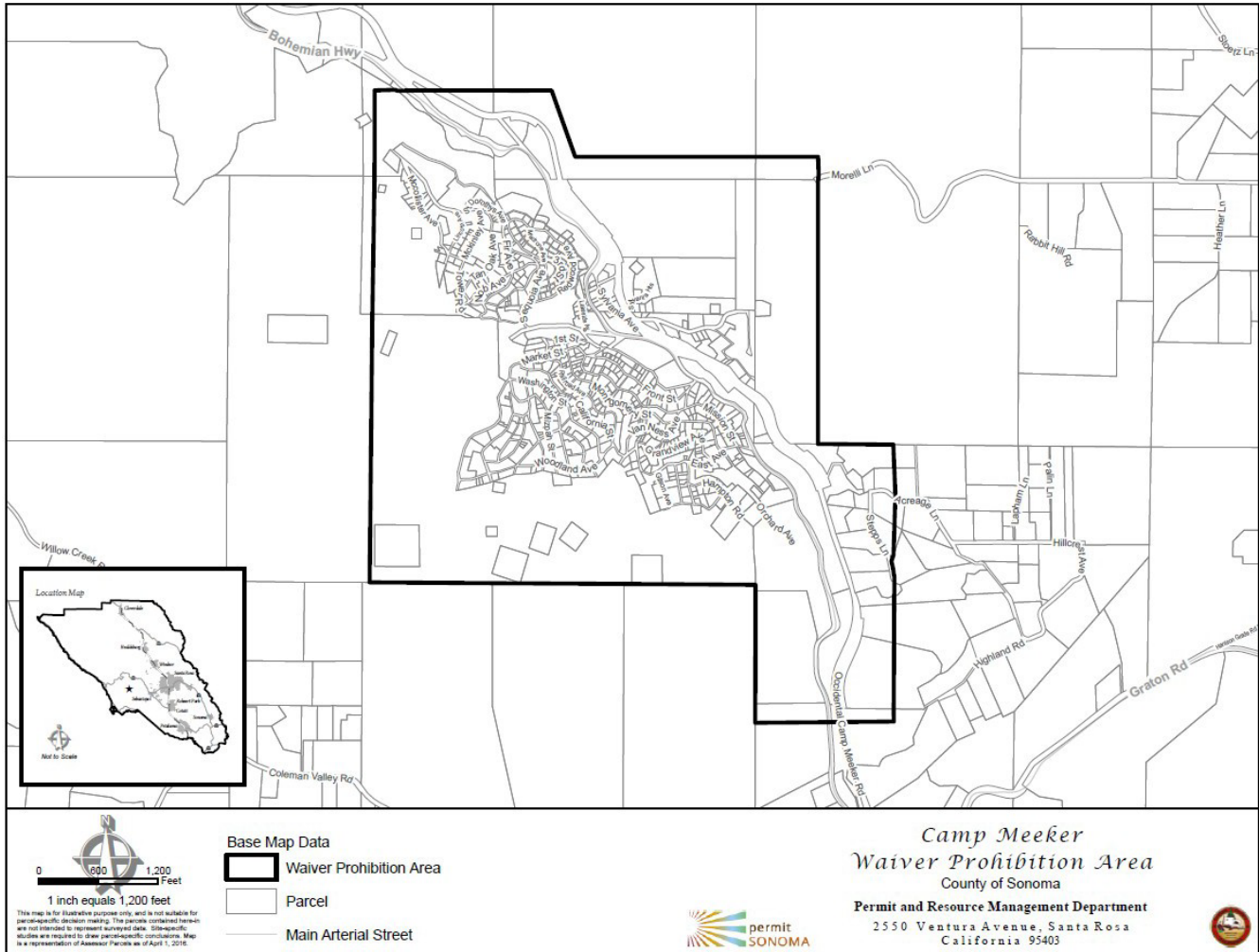

Map 18.2 Canon Manor

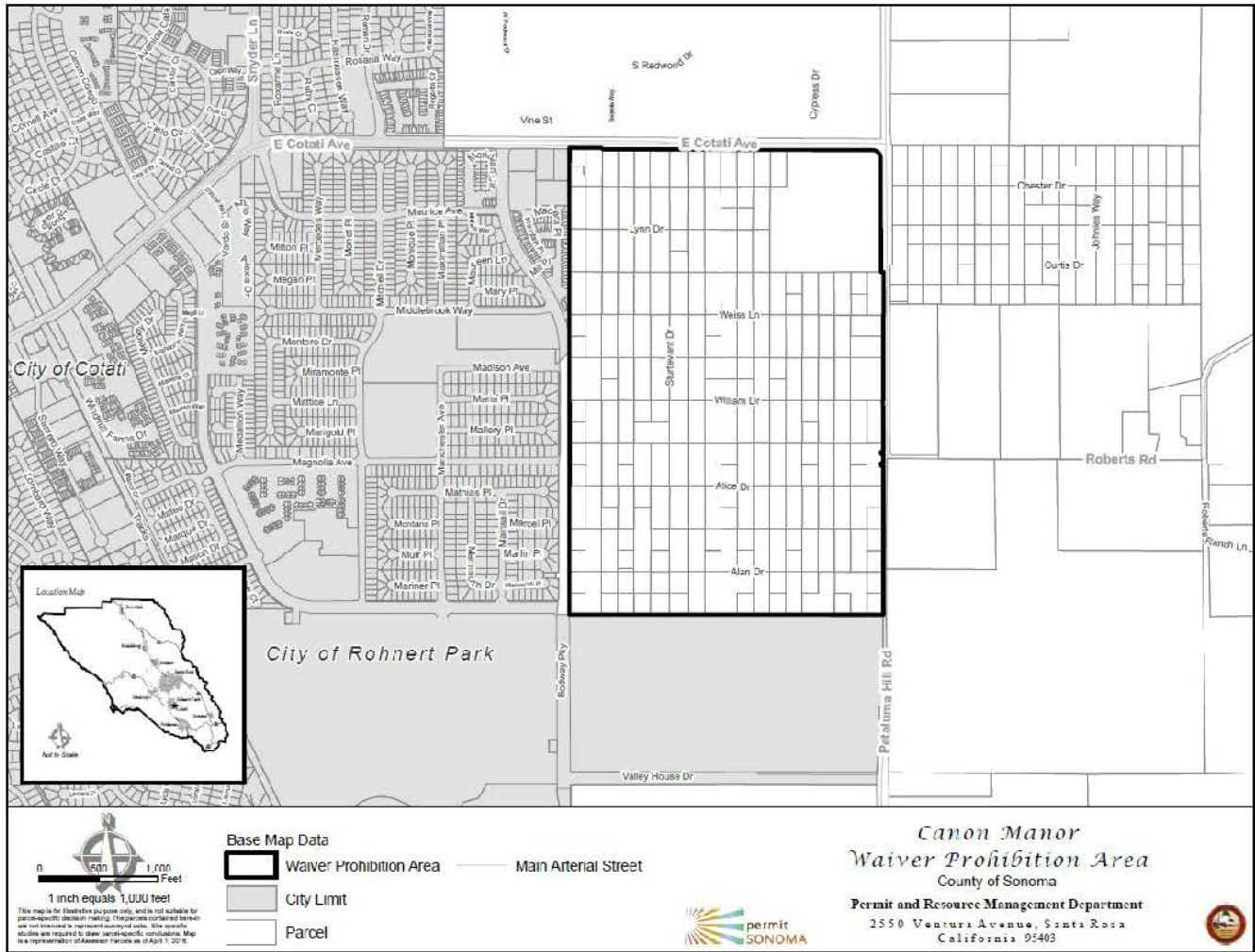

Map 18.3a Carmet

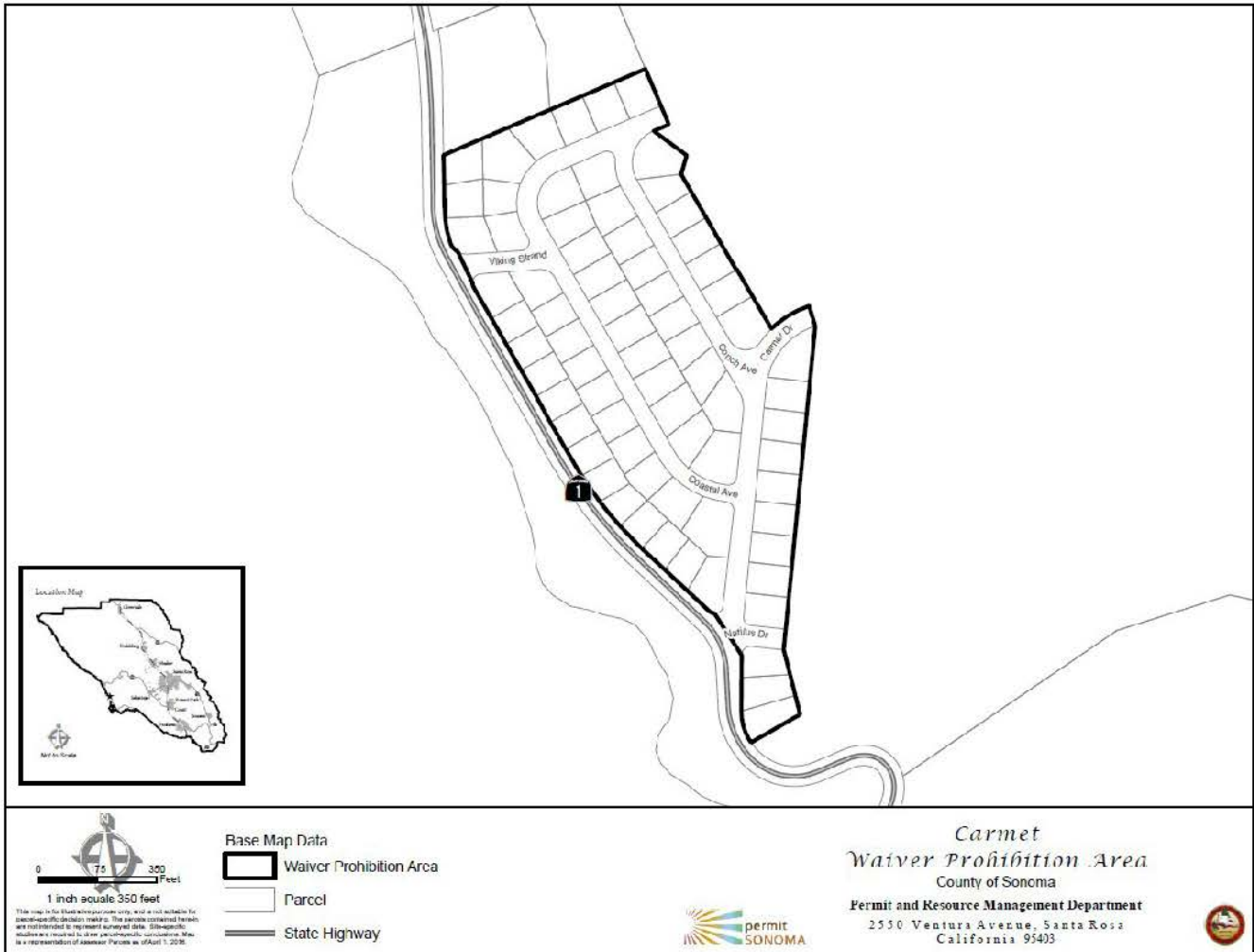

Map 18.3b Rancho del Paradiso

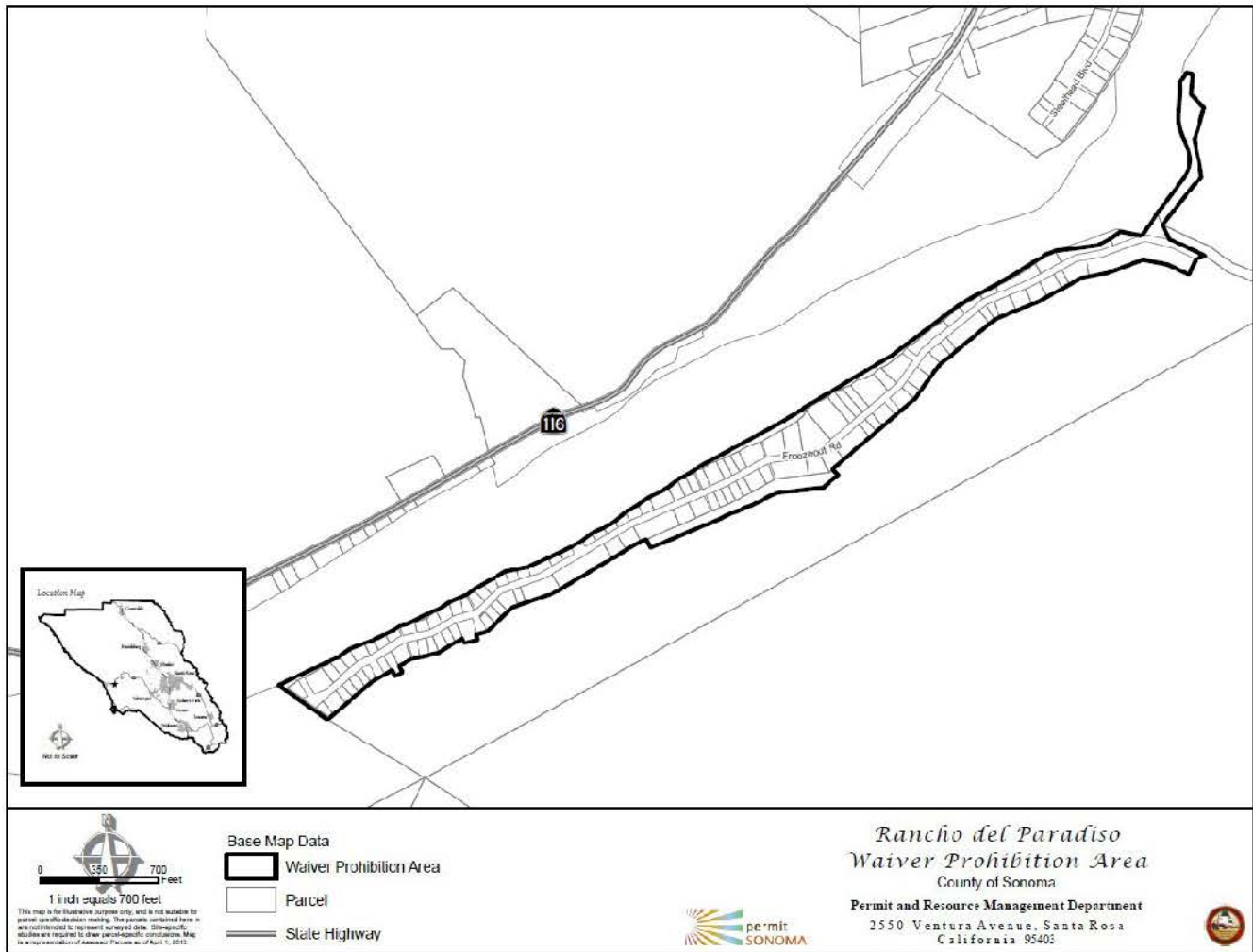

0 350 700 feet
1 inch equals 700 feet
This map is for illustrative purposes only, and is not suitable for general application. The permit applicant is responsible for providing accurate data. Site-specific information is required for the permit application. Map is a representation of the data as of April 15, 2015.

Base Map Data
 Waiver Prohibition Area
 Parcel
 State Highway

Rancho del Paradiso
Waiver Prohibition Area
 County of Sonoma
 Permit and Resource Management Department
 2550 Ventura Avenue, Santa Rosa
 California 95403

Author: PRMD GIS, Date: April 14, 2016

Map 18.3c Salmon Creek

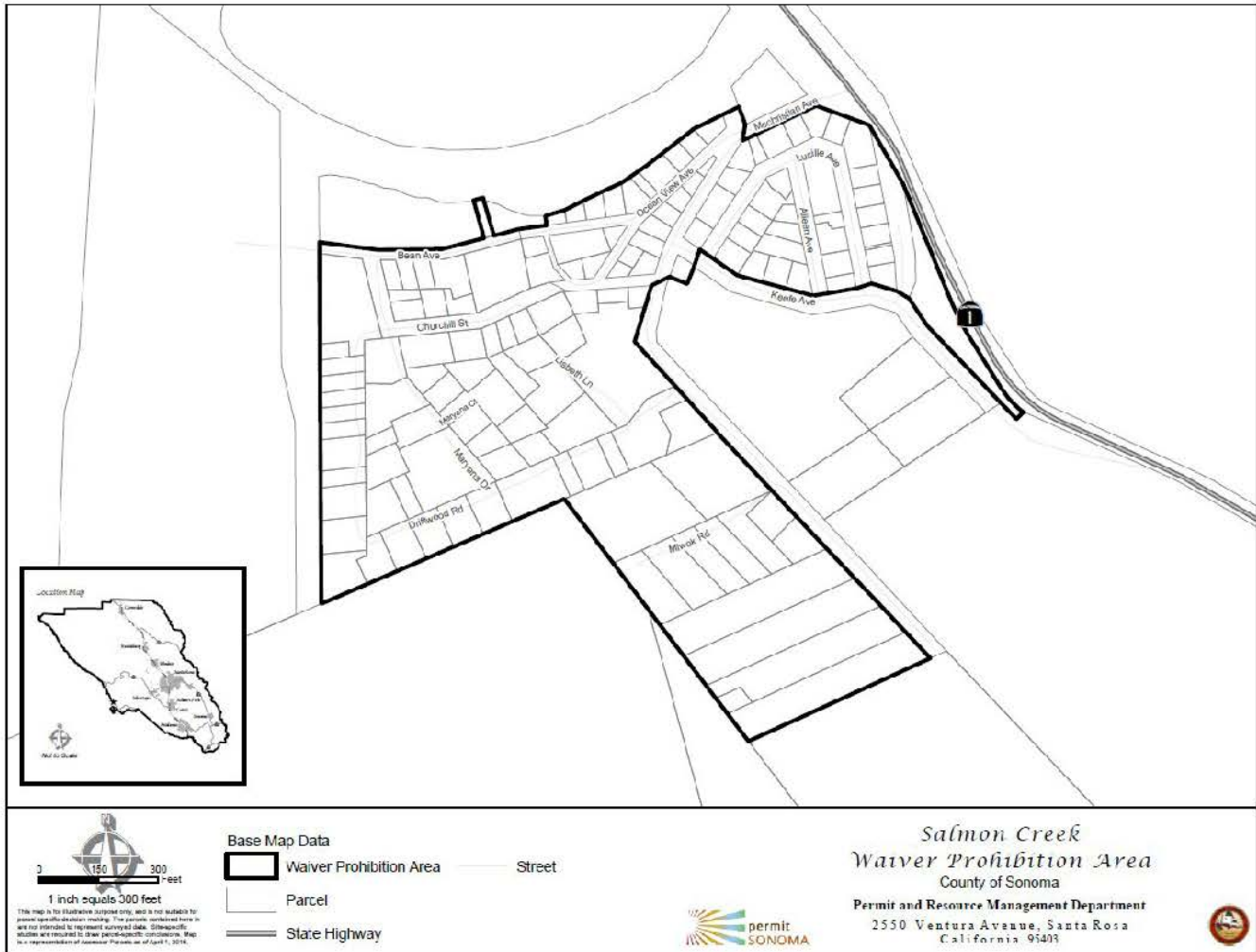

Map 18.3d Sereno del Mar/Gleason's Beach

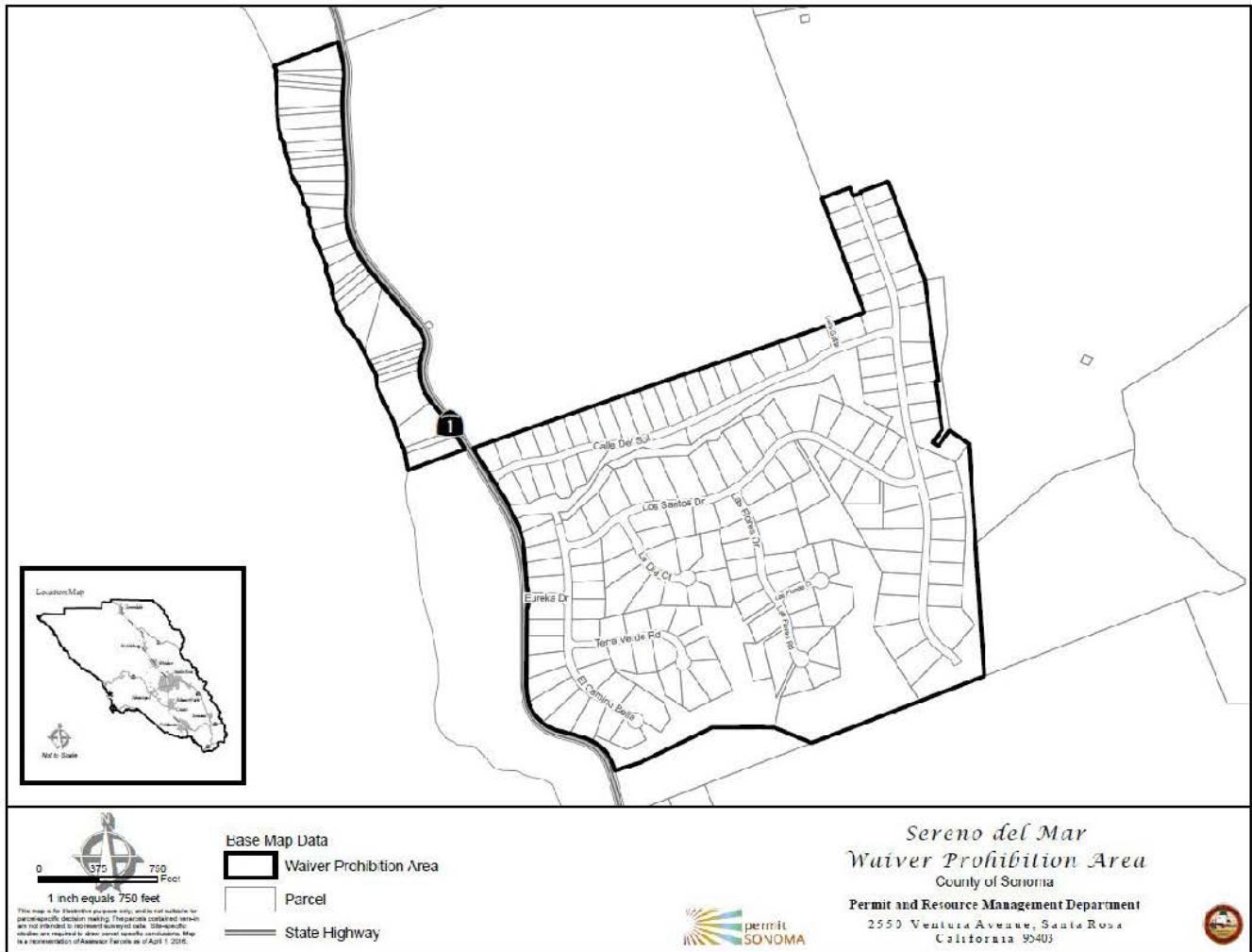

Map 18.3e Jenner

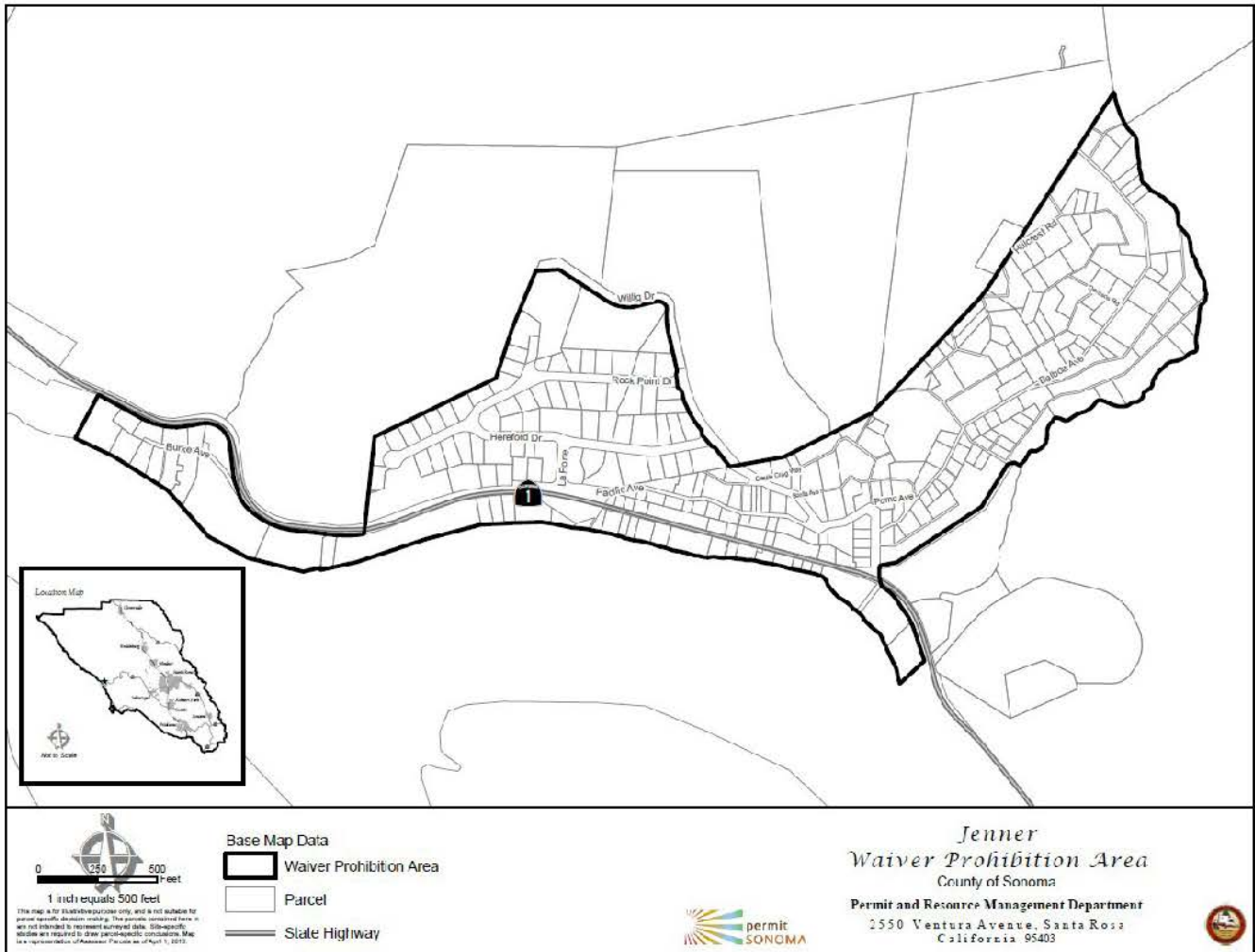

Map 18.4 Happy Acres

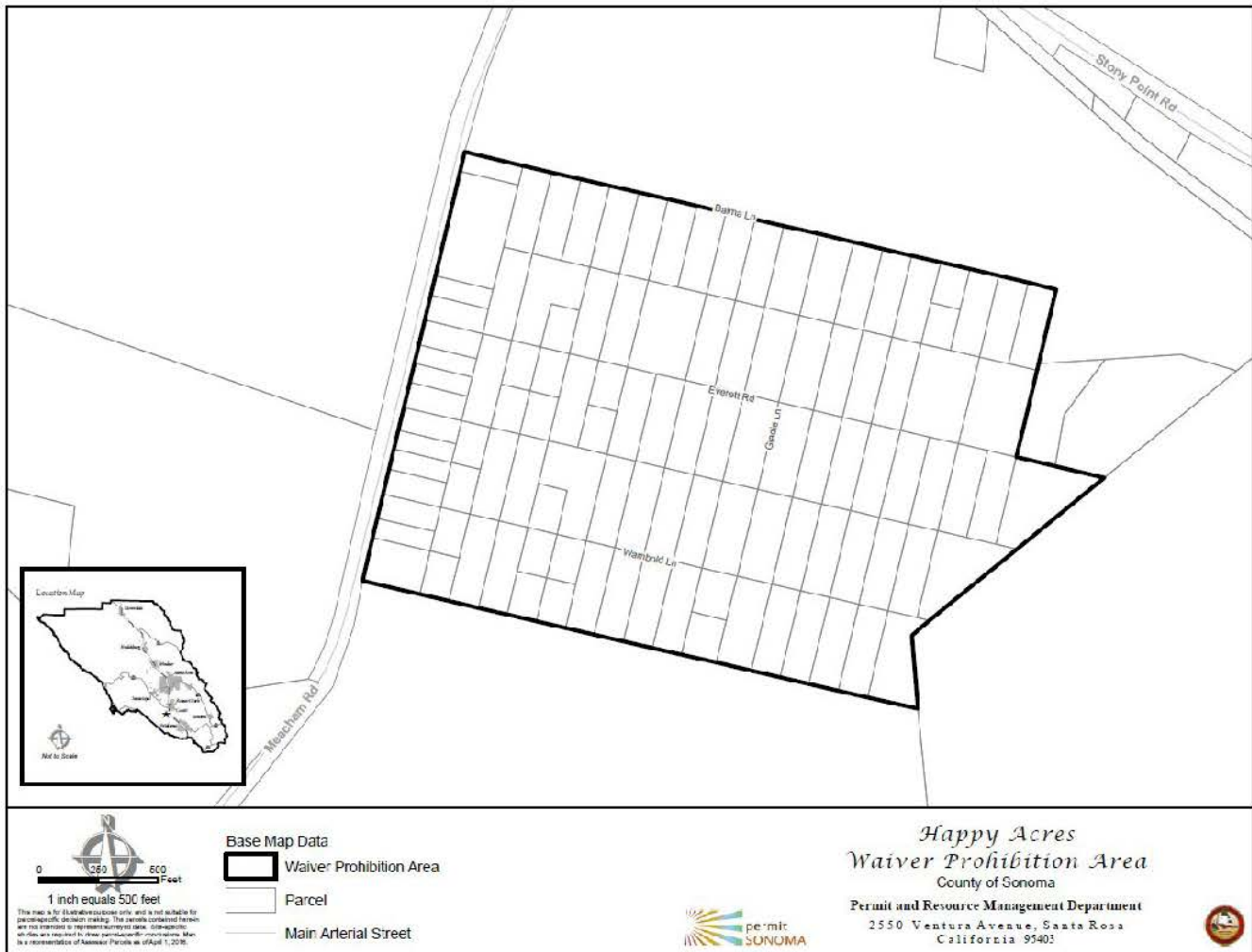

Map 18.5 Monte Rio

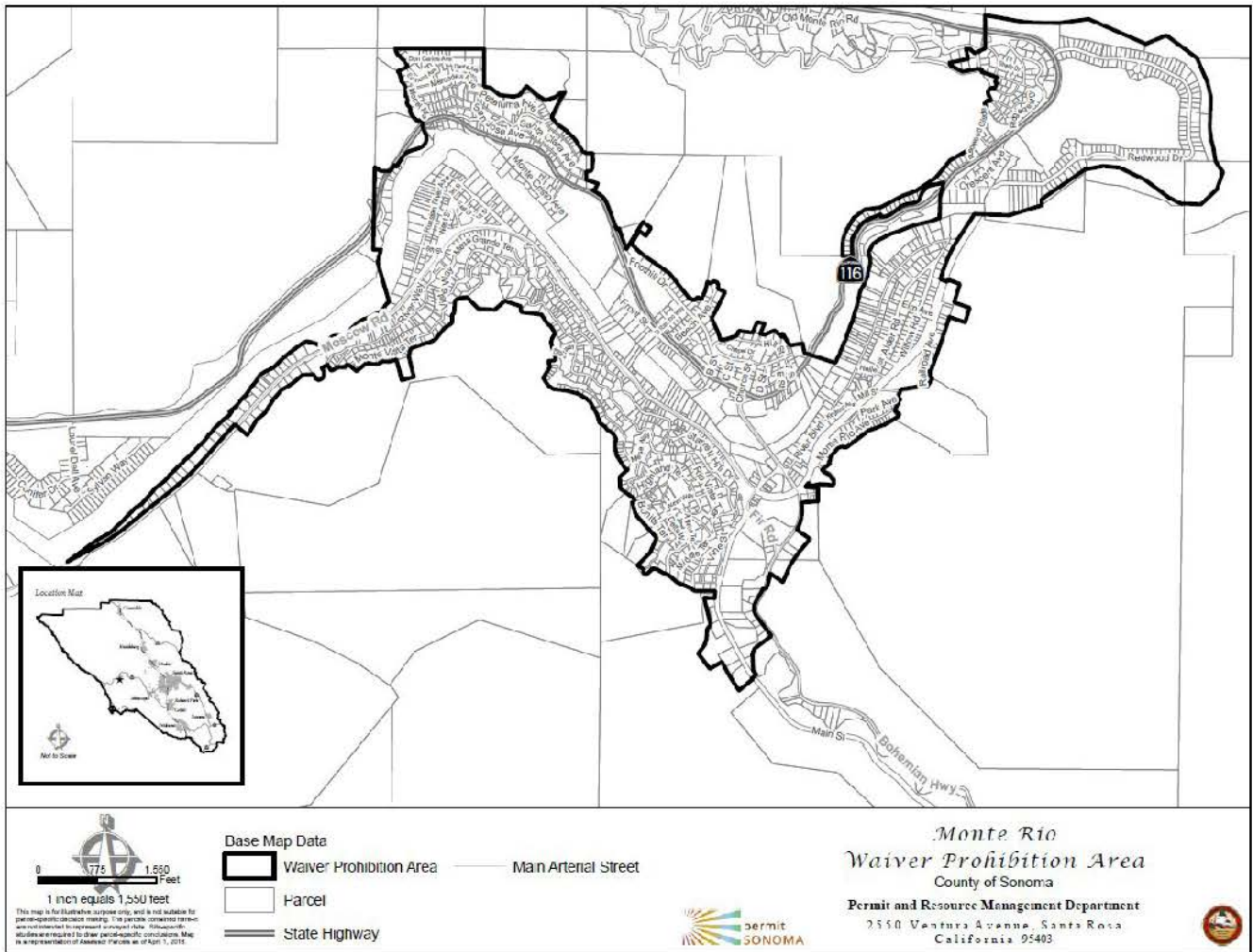

Author: PRMD GIS Date: April 11, 2016

Map 18.6 Penngrove/South Cotati

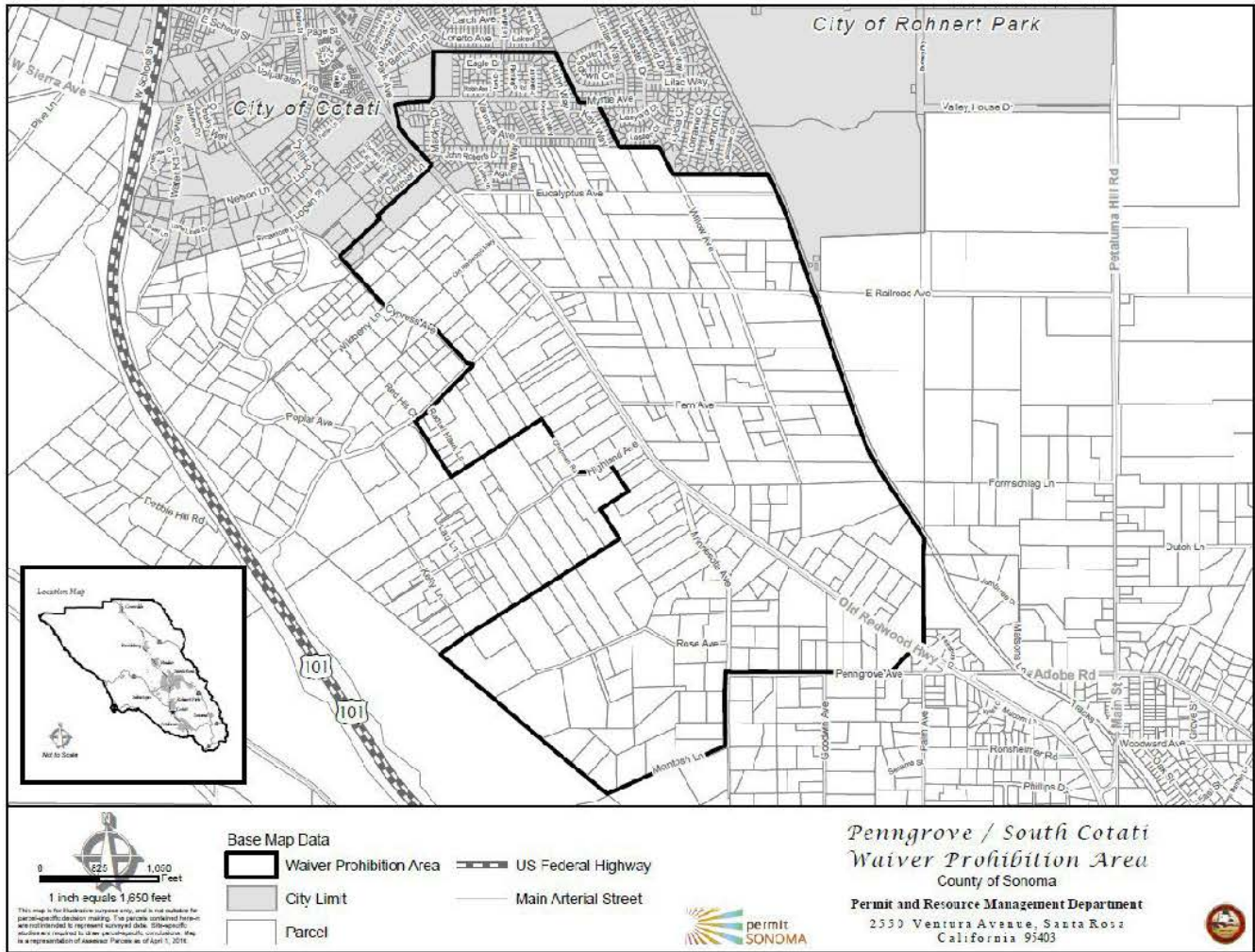

Map 18.7 West Petaluma

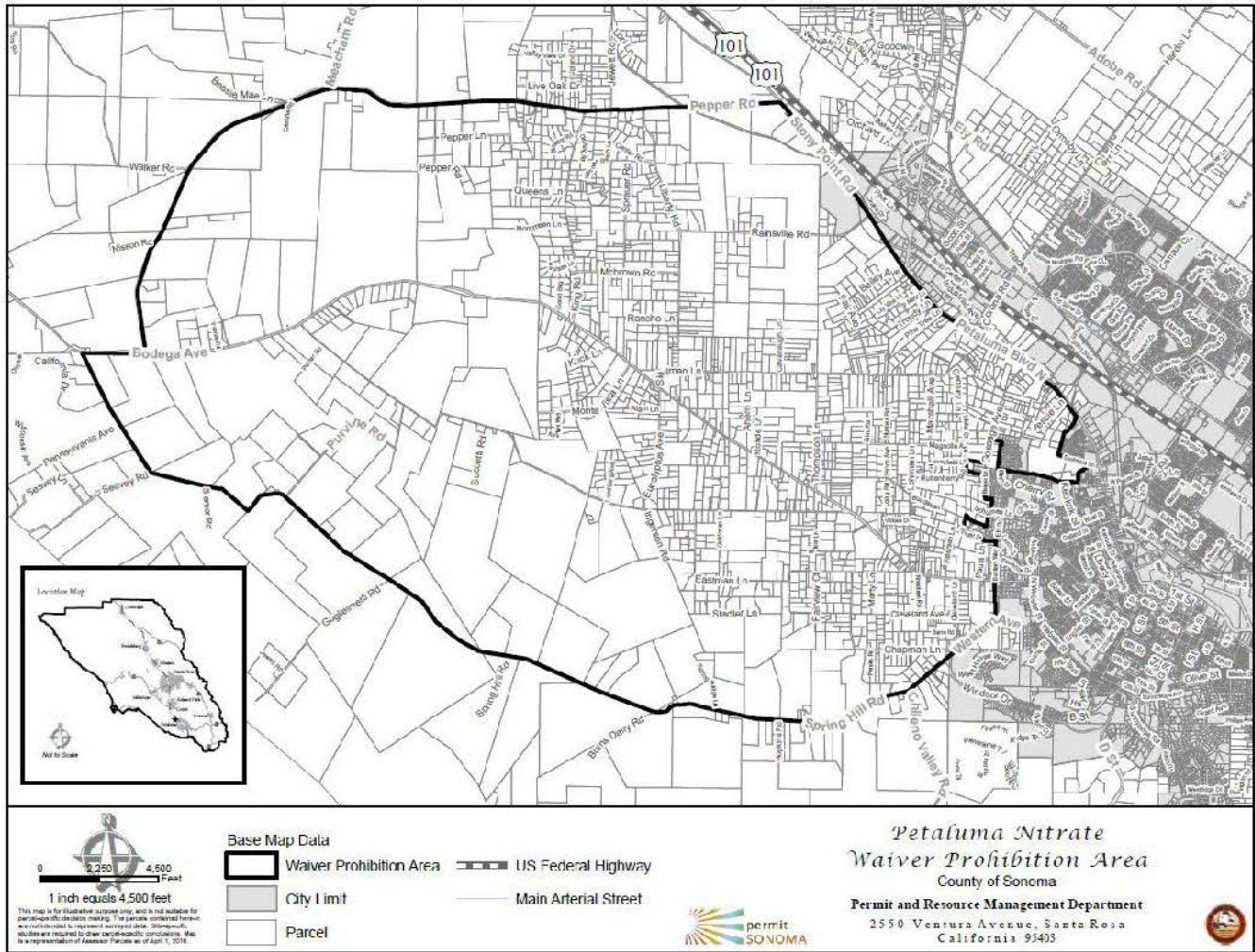

Map 18.8 Russian River Meadows

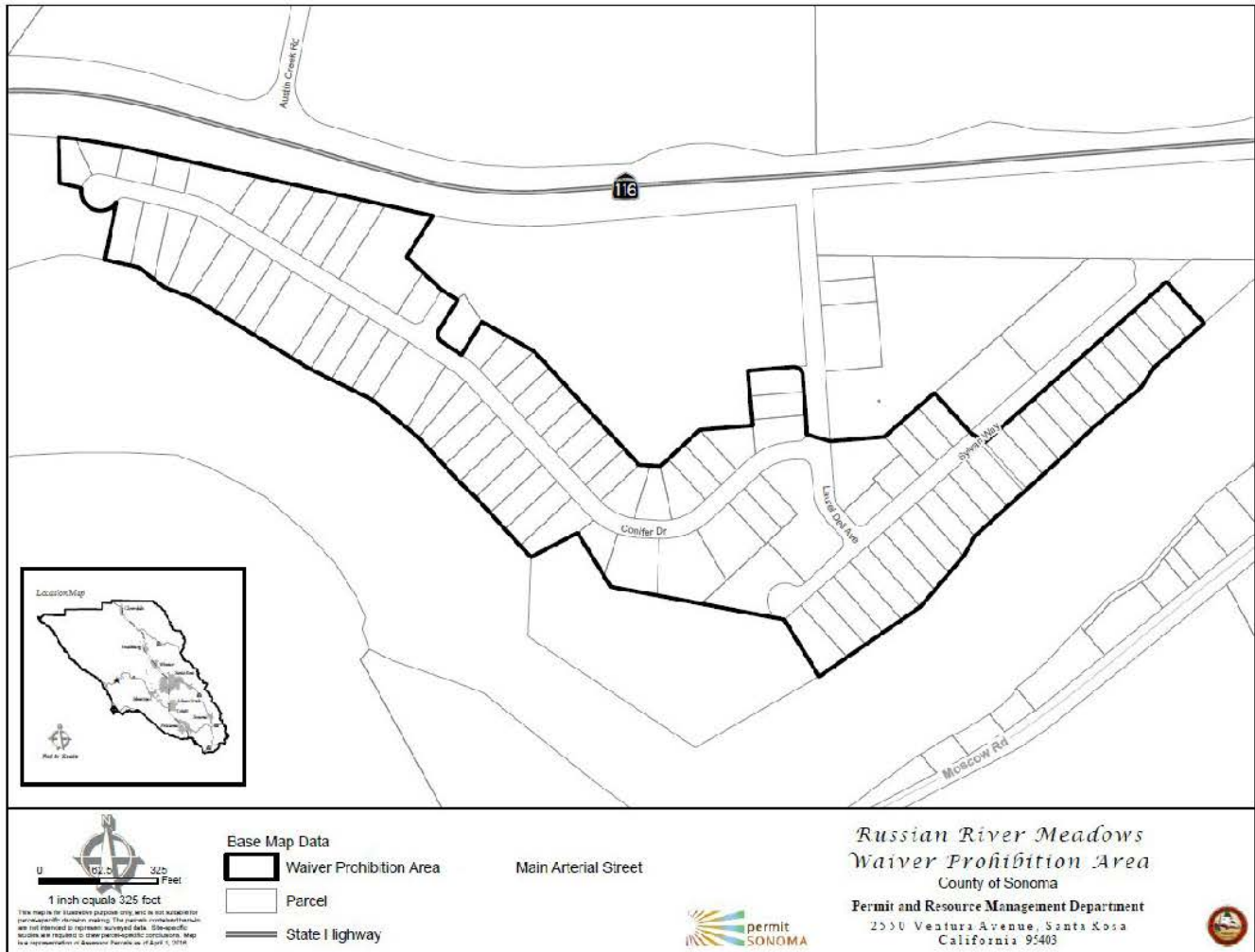

Author: PRMD GIS Date: April 14, 2016

Map 18.9 South Wright Road

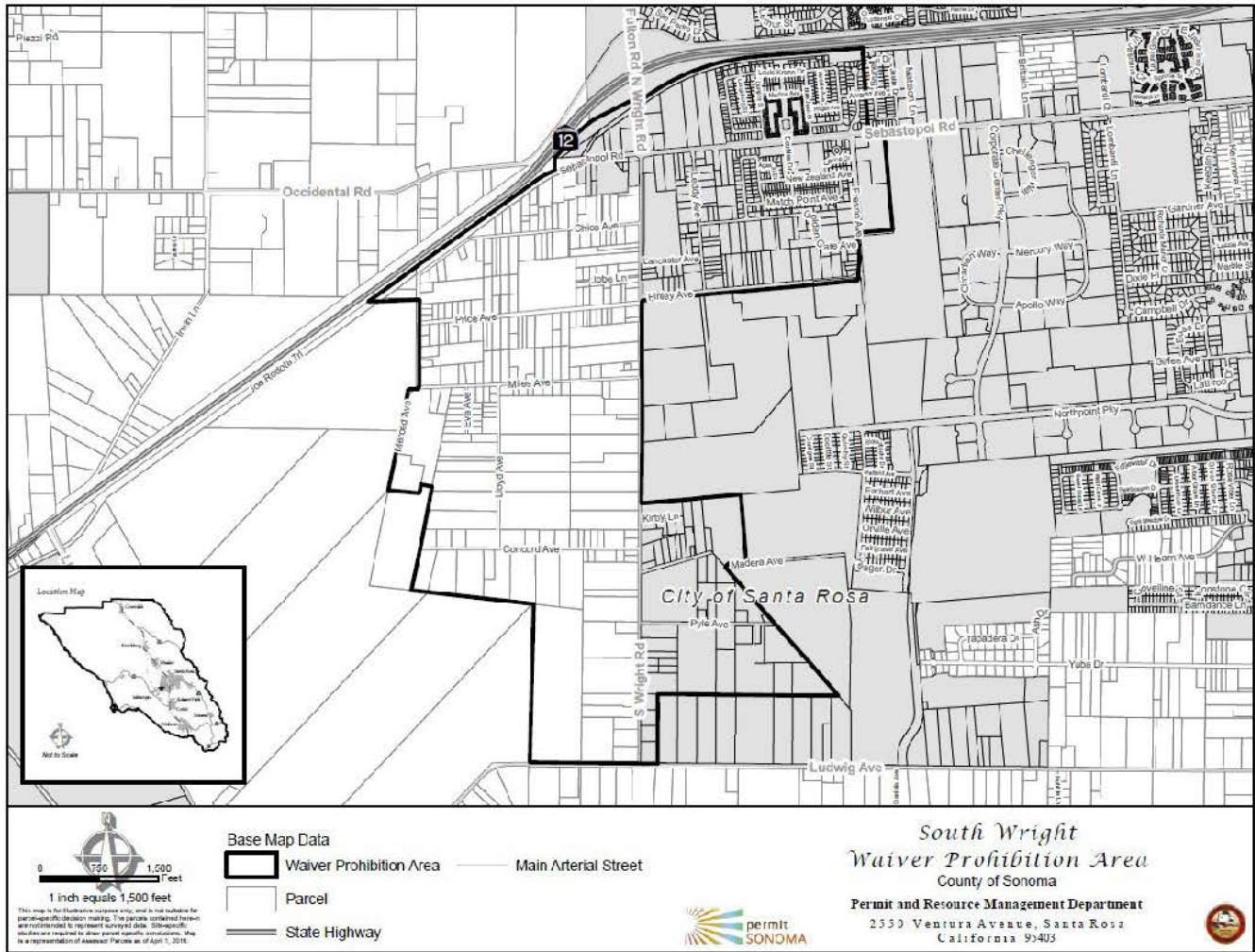

Map 18.10 Thomas Larkin Woods

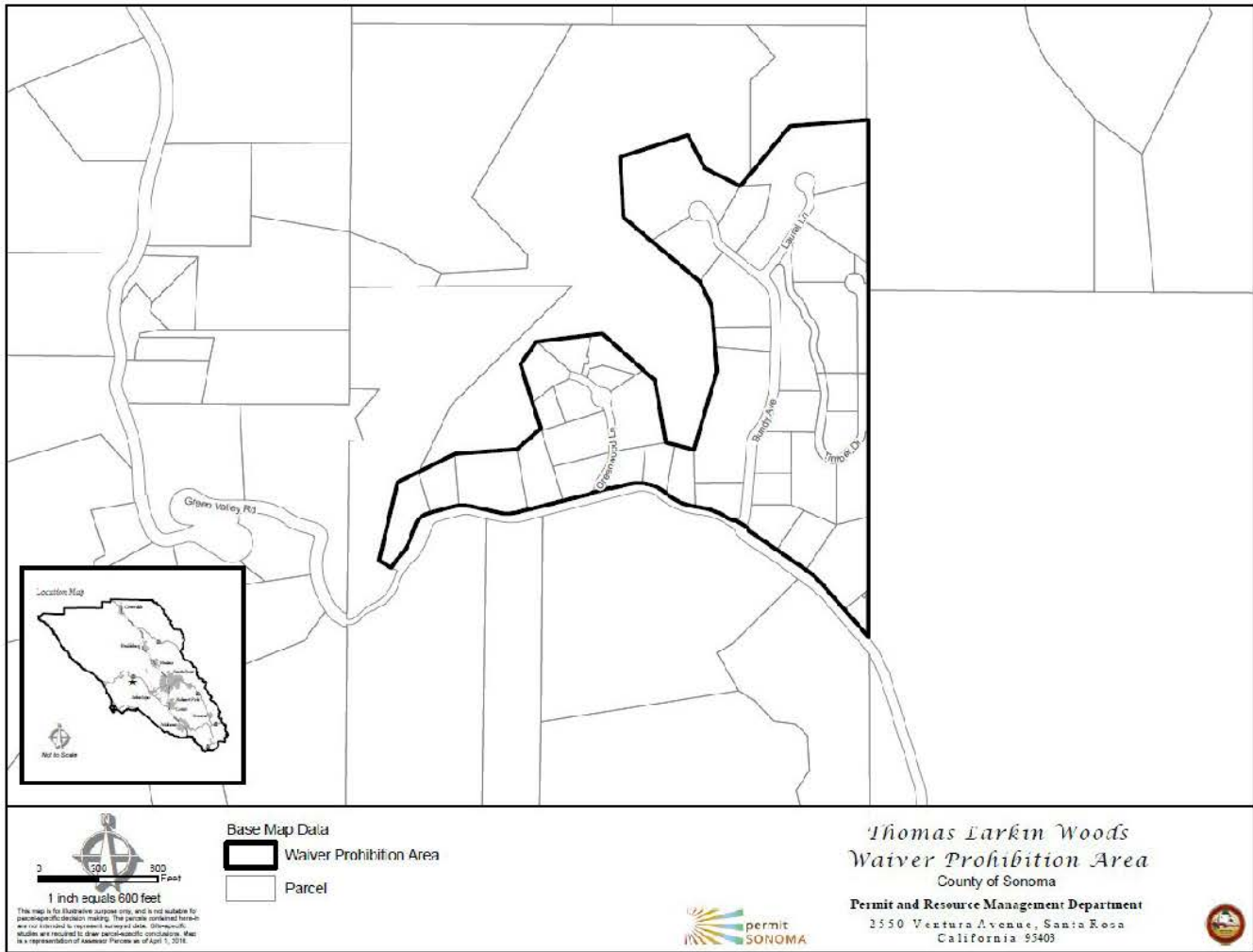

Aerial, PRMD GIS Date April 14, 2010

Map 18.11 Westvue Meadows

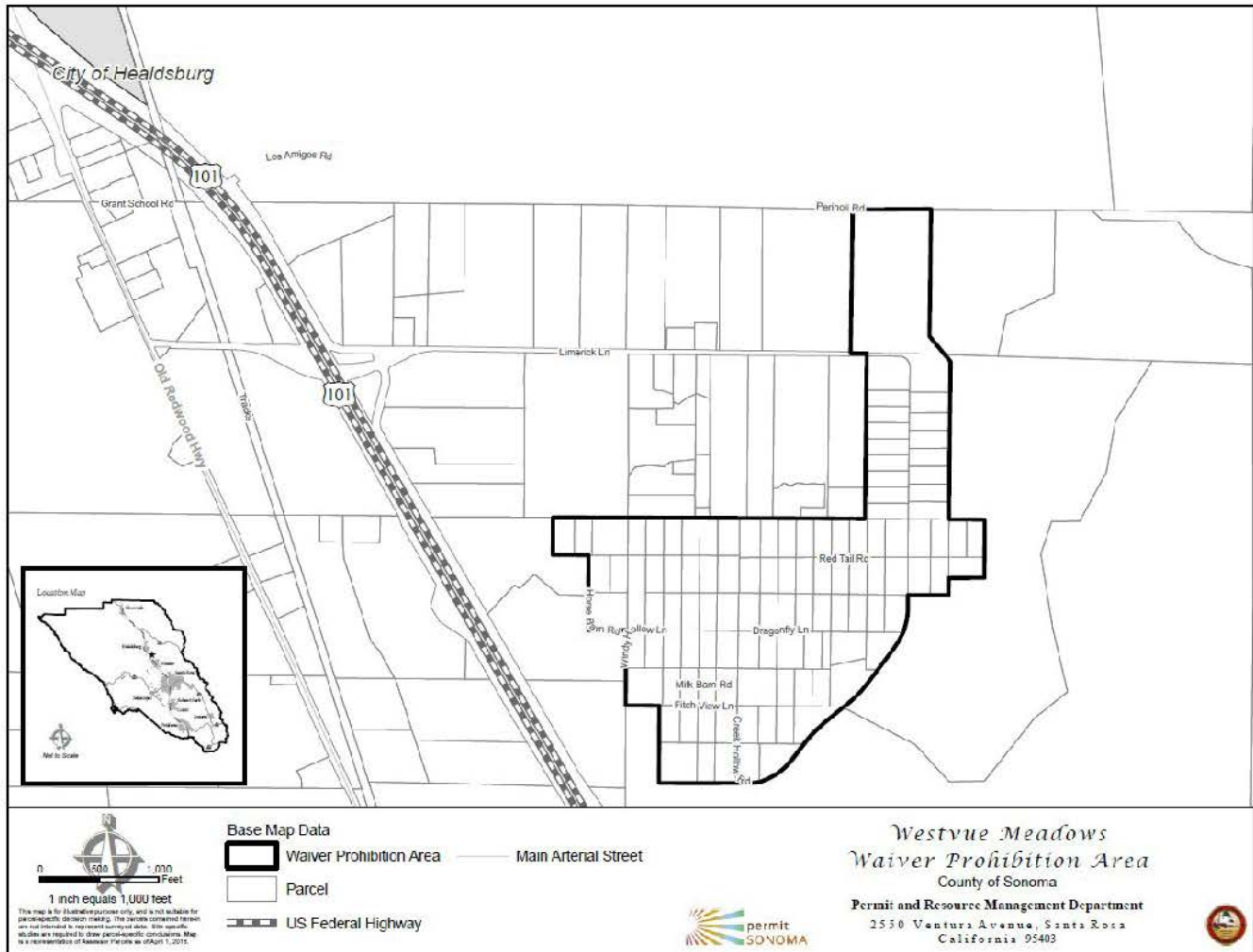

Author: PRMD C.G. Date: April 14, 2018

Section 19 OWTS Policy Tier 3, Total Maximum Daily Load and Advanced Protection Management Program

19 State OWTS Policy Tier 3

The State's OWTS Policy Tier 3 provides three approaches for water bodies that are classified as impaired pursuant to the Federal Clean Water Act section 303(d). These options include implementing the requirements of an approved TMDL Action Plan, implementing local requirements known as Special Provisions, or implementing the requirements within the State OWTS Policy Tier 3 section 10. Regardless the option used, the set of regulations for OWTS subject to Tier 3 are known as an Advance Protection Management Program.

The County of Sonoma provides the following Special Provisions as the County's Advance Protection Management Program to satisfy the State OWTS Policy Tier 3 requirements.

19.1 Advanced Protection Management Program / Special Provisions for the Russian River Watershed

This section constitutes the County of Sonoma's OWTS Policy Tier 3 Special Provisions for the Clean Water Act 303(d) water bodies listed as impaired for pathogens within the Russian River watershed.

Section 19.1 becomes effective when the North Coast Regional Water Quality Control Board amends their Basin Plan to incorporate an action plan to address OWTS within the Russian River watershed.

- A. The following river or stream reaches or watersheds are listed as impaired for pathogens pursuant to the Federal Clean Water Act section 303(d) and are listed in the State OWTS Policy Tier 3 as being subject to Tier 3 requirements. The mainstem Laguna de Santa Rosa is also listed for nitrogen.
- Mainstem Russian River from Fife Creek to Dutch Bill Creek
 - Mainstem Russian River at Healdsburg Memorial Beach and unnamed tributary at Fitch Mountain
 - Mainstem Laguna de Santa Rosa
 - Mainstem Santa Rosa Creek
 - Green Valley Creek watershed
- B. The Russian River Special Provision Impairment Areas (Impairment Area) consists of parcels that are completely or partially within 600 linear feet from the top of watercourse bank in the horizontal (map) direction on either side of an impaired water bodies listed in section 19.1.A.
- C. The applicability of these Special Provisions is determined by the location of the dispersal system. The OWTS dispersal system must be completely or partially within 600 linear feet from the top of the watercourse bank in the horizontal (map) direction on either side of the watercourse to be subject to these Special Provisions. OWTS with effluent dispersal systems entirely outside the 600 linear foot distance are not subject to these requirements.
- D. All OWTS in the Russian River Impairment Area shall meet the requirements of the County of Sonoma LAMP, including the OWTS Manual.

Map 19.1 Russian River 303(d) Water Bodies

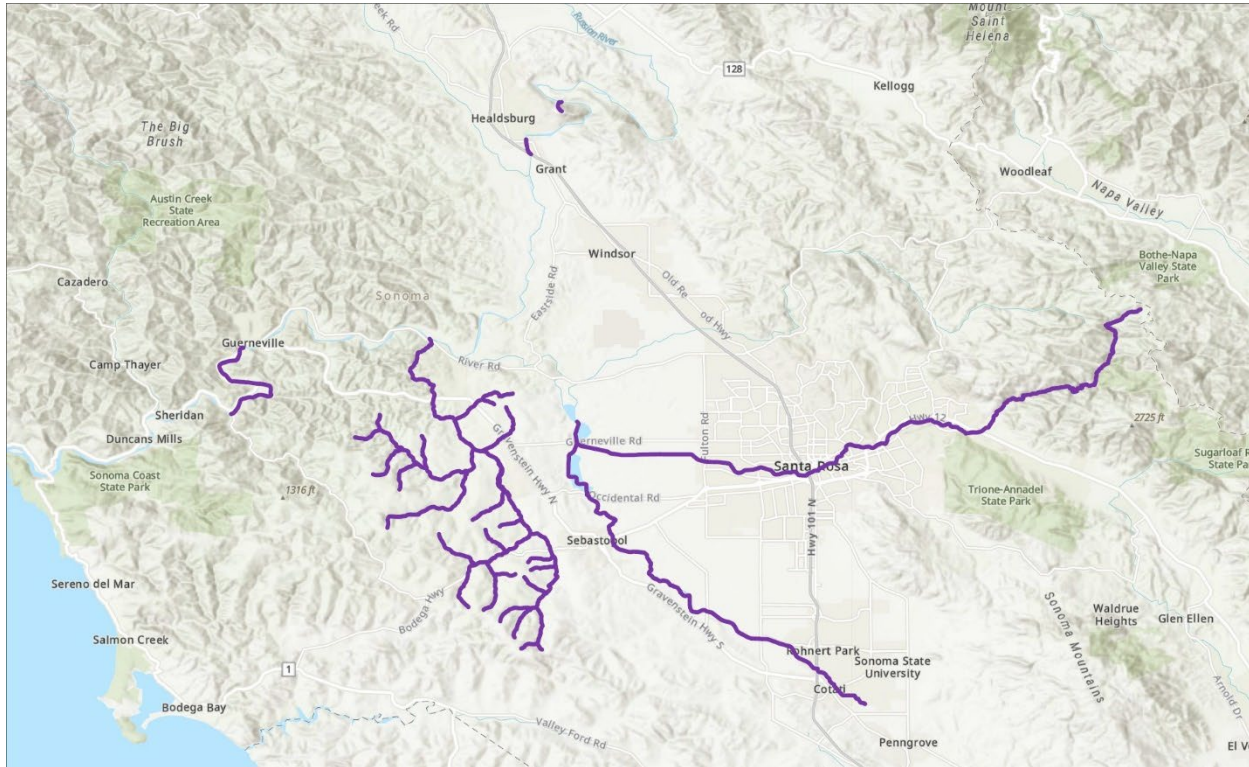

E. Impairment Area Special Provisions

1. All new or replacement OWTS dispersal systems shall include supplemental treatment components and/or enhanced effluent dispersal systems.
2. Supplemental treatment units for pathogen impairments listed in section 19.1.A shall be capable of producing effluent that meets the following effluent quality parameters:
 - a. Less than or equal to 30 milligrams per liter total suspended solids as a 30-day average.
 - b. Less than or equal to 200 MPN per 100 milliliters for fecal coliform bacteria.
3. Supplemental treatment units for nitrogen impairments listed in section 19.1.A shall be capable of producing effluent that reduces the nitrogen levels 50 percent or more when comparing the 30-day average influent nitrogen levels to the 30-day average effluent nitrogen levels.
4. OWTS with dispersal systems within the Impairment Area shall be enrolled in the County's Operational Permit and Monitoring program pursuant to OWTS Manual section 14.
5. Exception to 19.1.E.1. Supplemental treatment components and/or enhanced effluent dispersal system are not required when the following conditions exist:

Table 19.1A – Supplemental Treatment Exceptions

| Watercourse Setback (feet) | Depth to Groundwater (inches) | Percolation Rate (minutes per inch) | Wastewater Application Rate |
|---|-------------------------------|-------------------------------------|---|
| Less than 200 | 36 or more | 30-120 | Not to exceed the application rate set forth in State OWTS Policy Table 3 |
| 200 to 600 | 24 or more | 30-120 | |
| Watercourse setback shall be measured from the top of the watercourse bank to the closest point of the OWTS dispersal area. | | | |

Table 19.1B -- State OWTS Policy Table 3: Application Rates as Determined from Stabilized Percolation Rate

| Percolation Rate (MPI) | Application Rate (gal/day/sq ft) | | Percolation Rate (MPI) | Application Rate (gal/day/sq ft) | | Percolation Rate (MPI) | Application Rate (gal/day/sq ft) |
|------------------------|-----------------------------------|--|------------------------|----------------------------------|--|------------------------|----------------------------------|
| <1 | Requires Local Management Program | | 31 | 0.522 | | 61 | 0.197 |
| 1 | 1.2 | | 32 | 0.511 | | 62 | 0.194 |
| 2 | 1.2 | | 33 | 0.5 | | 63 | 0.19 |
| 3 | 1.2 | | 34 | 0.489 | | 64 | 0.187 |
| 4 | 1.2 | | 35 | 0.478 | | 65 | 0.184 |
| 5 | 1.2 | | 36 | 0.467 | | 66 | 0.18 |
| 6 | 0.8 | | 37 | 0.456 | | 67 | 0.177 |
| 7 | 0.8 | | 38 | 0.445 | | 68 | 0.174 |
| 8 | 0.8 | | 39 | 0.434 | | 69 | 0.17 |
| 9 | 0.8 | | 40 | 0.422 | | 70 | 0.167 |
| 10 | 0.8 | | 41 | 0.411 | | 71 | 0.164 |
| 11 | 0.786 | | 42 | 0.4 | | 72 | 0.16 |
| 12 | 0.771 | | 43 | 0.389 | | 73 | 0.157 |
| 13 | 0.757 | | 44 | 0.378 | | 74 | 0.154 |
| 14 | 0.743 | | 45 | 0.367 | | 75 | 0.15 |
| 15 | 0.729 | | 46 | 0.356 | | 76 | 0.147 |
| 16 | 0.714 | | 47 | 0.345 | | 77 | 0.144 |
| 17 | 0.7 | | 48 | 0.334 | | 78 | 0.14 |
| 18 | 0.686 | | 49 | 0.323 | | 79 | 0.137 |
| 19 | 0.671 | | 50 | 0.311 | | 80 | 0.133 |
| 20 | 0.657 | | 51 | 0.3 | | 81 | 0.13 |
| 21 | 0.643 | | 52 | 0.289 | | 82 | 0.127 |
| 22 | 0.629 | | 53 | 0.278 | | 83 | 0.123 |
| 23 | 0.614 | | 54 | 0.267 | | 84 | 0.12 |
| 24 | 0.6 | | 55 | 0.256 | | 85 | 0.117 |
| 25 | 0.589 | | 56 | 0.245 | | 86 | 0.113 |
| 26 | 0.578 | | 57 | 0.234 | | 87 | 0.11 |
| 27 | 0.567 | | 58 | 0.223 | | 88 | 0.107 |
| 28 | 0.556 | | 59 | 0.212 | | 89 | 0.103 |
| 29 | 0.545 | | 60 | 0.2 | | 90 | 0.1 |
| 30 | 0.533 | | | | | >90 - 120 | 0.1 |

Percolation Rate MPI means minute per inch.

Application Rate gal/day/sq ft means gallons per day per square foot.

19.2 Advanced Protection Management Program for the Petaluma River Watershed

This section constitutes the County of Sonoma's Advanced Protection Management Program for the Petaluma River Watershed and addresses the treatment and inspection requirements for OWTS within the program boundary.

- A. All OWTS in the Petaluma River APMP boundary shall meet the requirements of the County of Sonoma LAMP and OWTS Manual.
- B. Petaluma River APMP Boundary
 - 1. The APMP boundary in the Petaluma River watershed includes the following areas:
 - a. The area within 200 linear feet from the top of the bank in the horizontal (map) direction on either side of the entire Petaluma River main stem; or
 - b. The area within 200 linear feet from the top of the bank in the horizontal (map) direction on either side of any National Hydrography Dataset medium resolution mapped stream in the Petaluma River watershed.
- C. Applicable OTWS. All OWTS with the effluent dispersal system within or partially with the APMP. OWTS with effluent dispersal systems entirely outside the APMP are not subject to these requirements.
- D. Owners of applicable OWTS within the APMP boundary for the Petaluma River watershed shall maintain their OWTS as follows:
 - 1. Maintain the OWTS in good working condition, including inspections and pumping of solids, as necessary, or as required by local ordinances and requirements established in an approved LAMP, to maintain proper function and assure adequate treatment and disposal.
- E. Owners of applicable OWTS within the APMP boundary for the Petaluma River watershed shall have basic operational inspections of their OWTS as follows:
 - 1. Inspection frequency shall be within two years of January 1, 2022, and once every ten years thereafter.
 - 2. Inspections shall include the septic tank, effluent dispersal area(s), and related appurtenances of the OWTS. A basic operational inspection shall provide sufficient information to determine that the OWTS are not discharging any waste to the river or its tributaries. The inspections should evaluate ~~in~~ the following components:
 - a. Overall system
 - b. Septic tank
 - c. Pump Systems
 - d. Effluent Dispersal Area(s)
 - e. Supplement Treatment Units or Custom-Designed Systems
 - 3. Inspections shall be conducted by either a qualified professional or by a qualified inspector.

F. Need for Corrective Action

In addition to conditions requiring corrective action set forth in section 11.0 of the OWTS Policy, OWTS meeting any of the following criteria are also deemed to need corrective action and must be replaced, repaired, or modified so as to comply with requirements of an approved LAMP, WDRs, or a waiver of WDRs:

1. OWTS discharging to the ground surface or surface waters;
2. OWTS that do not include a septic tank and an effluent dispersal system that comply with the OWTS Policy; and
3. OWTS with projected wastewater flow exceeding the capacity of one or more components of the treatment and disposal system.

Map 19.2 Petaluma River APMP Boundary

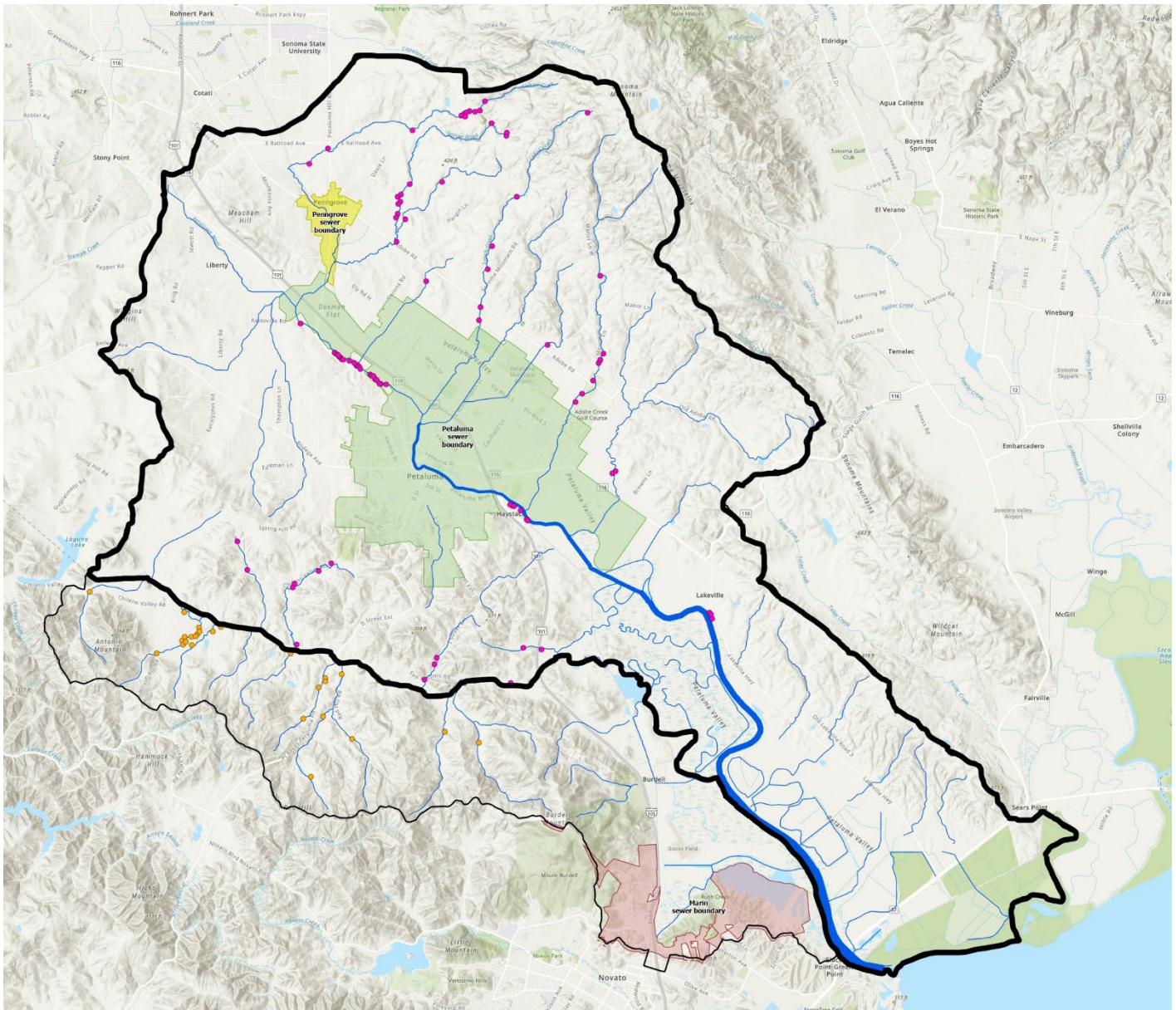

19.3 Advanced Protection Management Program for the Sonoma Creek Watershed

This section constitutes the County of Sonoma's Advanced Protection Management Program for the Sonoma Creek Watershed and addresses the treatment and inspection requirements for OWTS within the program boundary.

- A. All OWTS in the Sonoma Creek APMP boundary shall meet the requirements of the County of Sonoma LAMP and OWTS Manual.
- B. Sonoma Creek APMP Boundary
 - 1. The APMP boundary is the Sonoma Creek watershed.
- C. Applicable OTWS. All OWTS with the effluent dispersal system within or partially with the APMP. OWTS with effluent dispersal systems entirely outside the APMP are not subject to these requirements.
- D. Owners of applicable OWTS within the APMP boundary for the Sonoma Creek watershed shall maintain their OWTS as follows:
 - 1. Maintain the OWTS in good working condition, including inspections and pumping of solids, as necessary, or as required by local ordinances and requirements established in an approved LAMP, to maintain proper function and assure adequate treatment and disposal.
- E. Need for Corrective Action.

In addition to conditions requiring corrective action set forth in section 11.0 of the OWTS Policy, OWTS meeting any of the following criteria are also deemed to ~~be in~~ need of corrective action and must be replaced, repaired, or modified so as to comply with requirements of an approved LAMP, WDRs, or a waiver of WDRs:

- 1. OWTS discharging to the ground surface or surface waters;
- 2. OWTS that do not include a septic tank and an effluent dispersal system that complies with the OWTS Policy; and
- 3. OWTS with projected wastewater flow exceeding the capacity of one or more components of the treatment and disposal system.

Map 19.3 Sonoma Creek APMP Boundary

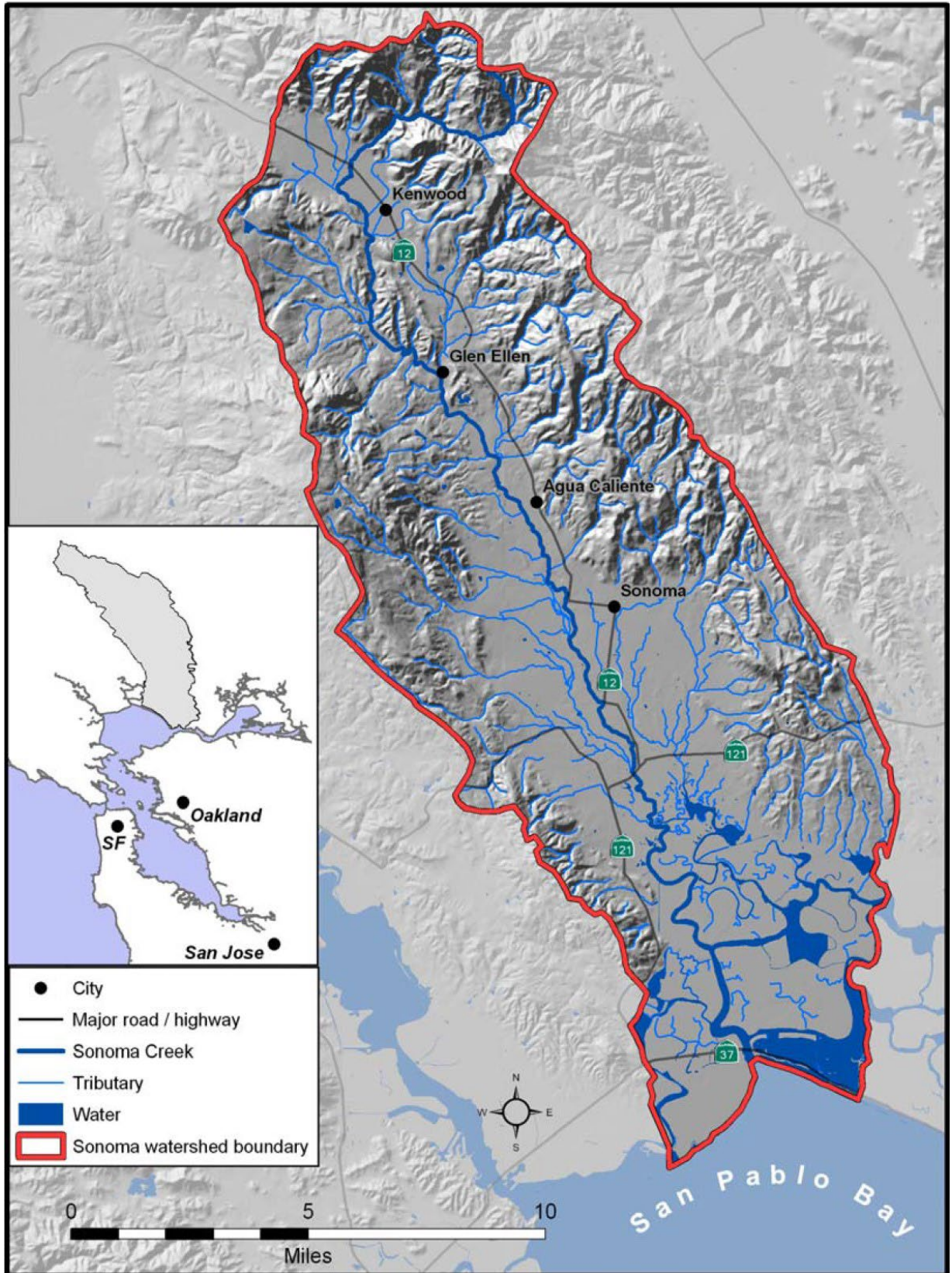

20 State OWTS Policy Tier 4 – Corrective Action

State OWTS Policy Tier 4 provides requirements for OWTS that need corrective action or are presently failing or fail at any time while the OWTS Policy is in effect.

The County of Sonoma provides the following approaches to satisfy the State OWTS Policy Tier 4 requirements. This section provides for a range of options for corrective action within the County of Sonoma.

20.1 Conditions. The following conditions shall apply to all work pursuant to this section.

- A. The property is served by a cesspool or an existing OWTS that is in a state of failure as defined in section 3.
- B. The parcel is currently developed with a dwelling.
- C. There is no increase in wastewater flow or no increase in the number of bedrooms.
- D. The corrective action is not to authorize new or additional development or re-construction of existing structures on the subject property.

20.2 Options for Corrective Actions. The options for corrective actions include, but are not limited to, the following:

- A. A repair that is permit exempt pursuant to section 4.10.F Permit Exemptions.
- B. A repair under a permit pursuant to section 4.10.D – Repair OWTS Construction Permit.
- C. An in-kind replacement within an existing dispersal area as a repair permit pursuant to section 4.10.D – Repair OWTS Construction Permit.
- D. A replacement system under a repair permit pursuant to section 4.10.D – Repair OWTS Construction Permit.
- E. Cesspool conversion pursuant to section 20.C
- F. A substantial conforming system pursuant to section 20.D.
- G. A conforming replacement system pursuant to section 4.10.C – Replacement OWTS Construction Permit and with section 19, if applicable.

20.3 Cesspool Conversion

- A. This section allows for the conversion of a cesspool per section C.3 without the typical on-site investigation associated with a replacement OWTS.
- B. The on-site investigation parameters being waived include:
 - i. Soil evaluations also known as a pre-perc evaluation
 - ii. Percolation tests
 - iii. Groundwater elevation determinations

- C. Typical work includes pumping the contents of the cesspool, scarifying the walls and bottom as needed, adding a gravel pack to the pit, install dispersal piping within the scarified pit and installing a septic tank.
- D. An application and filing fee are required pursuant to section 4.7.
- E. A site review within the plan review process shall be conducted prior to construction.

20.4 Substantial Conforming OWTS Process

This section provides a process for the proposal of a substantially conforming OWTS. A substantially conforming system is still subject to section 20.A General Criteria. Following the numerated process, a discussion of each step is presented.

1. Evaluate the available site area of a given parcel.
2. Evaluate sub-surface design parameters.
3. Establish a system design area.
4. Consider a Code Compliant OWTS.
5. Consider a substantial conforming system.
6. Design of substantially conforming OWTS.
7. Documentation
8. Emergencies

Available Site Area:

Available site area is the land area that might be used for a septic system. There are land encumbrances on every site that reduce the available site area. Land encumbrances include existing structures, dwellings, garages, driveways, porches, patios and so forth. Land encumbrances also include land formations such as cut banks, streams, wetlands, and other features that are not appropriate for placement of an onsite septic system. Land encumbrances also include codified setbacks such as from wells, streams, biotic resources area, cut banks and structures.

The available site area for onsite septic systems are those unencumbered land areas that remain after identifying existing land encumbrances. The surface-based land encumbrances are one form of site constraints.

Design Parameters:

Sub-surface design parameters for septic systems include the soil type, the depth of soil, the separation to groundwater and the percolation rates. Septic systems are mostly in ground systems and knowledge of the sub-surface parameters are crucial to the design a septic system or to rule out a system. Sub-surface conditions, if not acceptable, can be thought of as a second form of a site constraint.

Each on-site evaluation location has an effective radius. These are 50 feet, 50 feet and 25 feet radii for soil evaluation (type and depth), groundwater readings, and percolation rate, respectively. A circle is created based on the radius and a square is superscribed on the outside of the circle. The squares make up the design area. The design areas (squares) can be combined to make one larger area or separated in differing areas on the parcel.

Design Area:

The septic design area is the land area in which a septic system can be potentially constructed. To

establish the septic design area, one starts with the overall parcel, subtracts out any surface-based encumbrances, and includes areas of acceptable sub-surface design parameters.

Code Compliant Systems:

If the site parameters provide for a code compliant system, a code compliant system shall be proposed. Code compliant systems shall comply with the appropriate sections of this OWTS Manual.

Substantial Conforming System:

If demonstrated that a code compliant system cannot be installed, a substantially conforming system may be pursued.

The intent is to create the best possible system for the given site constraints. The substantially conforming system needs to take all the surface site constraints and all the sub-surface site constraints into account in its design.

The proposal must also present the surface and subsurface site constraints, how the site constraints detract from a code compliant system, and which code complying standards cannot be achieved.

Documentation:

Each step of this process shall be documented and submitted with the substantially conforming system design application.

Emergency Situations:

When immediate solutions are needed or desired, one of the repair options above should be pursued in the short term, while a code compliant system or substantially conforming system is designed and funded.

Section 21 Waterless Toilets

21.1 Purpose

- A. Many properties in Sonoma County have site constraints – lot size, topography, soil type - that make existing system compliance with OWTS standards difficult.
- B. Composting, incineration, and other technologies can supplement OWTS operations and extend their use under certain circumstances and appropriate monitoring.
- C. A waterless toilet (WT) that complies with this section may augment an existing OWTS in a manner that affords better compliance with the objectives of OWTS regulation.
- D. Since the composting process does not eliminate pathogens such as viruses, protozoans, and helminths, this section establishes conditions under which a WT can be considered as an augmentation to and not as a substitute for an existing OWTS to further the objective of OWTS regulation.
- E. The installation, use and maintenance of WT must occur in a manner that protects public health and the environment and does not create a public nuisance.

21.2 Use Standards

- A. Waterless toilets may be included in an existing or new OWTS to serve existing or new development.
- B. Waterless toilets are not authorized for the following types of development;
 - 1. Increases in wastewater flow and/or increase in strength for existing uses;
 - 2. Flow rates of 600 gallons per day or more for new single family homes;
 - 3. Flow rates of 1,000 gallons per day or more for new commercial establishments;
 - 4. Subdivision of land;
 - 5. Properties within a sewer hookup area, septic tank ban area, or County-identified Variance Prohibition Areas, except as a replacement; ~~and~~
 - 6. Vacation rental properties.

21.3 Development Standards

- A. A waterless toilet shall meet National Sanitation Foundation (NSF 41) criteria and shall be NSF certified and have the NSF seal.
- B. The product of composting toilets qualifies under federal regulation 40 CFR 503 as a biosolid which is also categorized as sewage sludge and must be handled and disposed of by a licensed septage hauler.
- C. The waste product of the incinerator toilet must be transported or disposed of in a manner that

does not create a public nuisance and is in accordance with the requirements of the Operation and Maintenance Manual.

- D. The owner must maintain the waterless toilet in accordance with the OM&M manual and comply with the special permit conditions.
- E. No material shall be placed in a waterless toilet other than the material for which it has been designed.
- F. The waste product of the waterless toilet shall only be handled and disposed of after the digestion process is complete as specified in the manufacturer's instructions.
- G. The waste product of a composting toilet shall be hauled off-site to an approved location by a licensed and certified hauler by the Sonoma County Environmental Health Division. A contract with a licensed/certified hauler is required.
- H. The composting process has not been proven to eliminate all pathogens the handling of the compost material shall be done with protective sanitation measures and include the use of disposable gloves and handwashing with soap and hot water.
- I. A waterless toilet shall be capable of reliably performing decomposition, settling or solids separation, nutrient and pathogen reduction, and avoidance of nuisance conditions. Features to be evaluated include, but are not limited to the following:
 - 1. Time and temperature control;
 - 2. Solids mixing or turning ability;
 - 3. Liquid fraction separation;
 - 4. Sizing and storage capacity for solids;
 - 5. Composting residence time;
 - 6. Ventilation;
 - 7. Electrical and or mechanical components;
 - 8. Piping;
 - 9. Aerobic conditions;
 - 10. Moisture content;
 - 11. Required additives;
 - 12. Operation and maintenance;
 - 13. Vector controls.
- J. A notice shall be placed on the property deed that states there is a waterless toilet that serves the structure(s) and the owners of said property are required to be in the waterless toilet monitoring program. The owner shall maintain the provisions required in the special permit.

21.4 Administration

- A. A special permit is required for use of a WT. The owner must renew the special permit on an annual basis.
- B. A person or company shall make a building permit application requesting the specific design to be installed.
- C. For composting toilets, the person or company shall make an application requesting to be entered into a composting toilet monitoring program.
- D. The application contents shall include:
 - 1. Name and address of applicant.
 - 2. Manufacturer's name and model number.
 - 3. Manufacturer's NSF listing and certification.
 - 4. Manufacturer's recommended operational capacity.
 - 5. Technology description and technical details to satisfy Section 12.2.B.
 - 6. For composting toilets, the name and business address of the licensed/certified hauler under contract.
 - 7. Discussion of specific operational requirements and/or operational training needed to successfully operate the proposed unit.
 - 8. Operation and maintenance manual.
 - 9. The appropriate filing fee.

Section 22 Waste Discharges Not Authorized by the SWRCB OWTS Policy

22.1 Domestic Waste Not In Compliance with the SWRCB OWTS Policy

This section provides a process for the OWTS that would normally be administered by the Permit Authority but is not in compliance with one or more prohibitions or standards contained in the SWRCB OWTS Policy.

- A. To mitigate OWTS Manual prohibition 4.2.B.8 and 4.2.B.9 (vertical separation to groundwater):
1. The owner shall submit a design to the Permit Authority that satisfies Section 20.2, Advanced Protection Management Measures.
 2. Upon plan review approval by Permit Authority, the owner shall ~~the~~ file a Notice of Intent with the appropriate RWQCB for waste discharge requirements, waiver of waste discharge requirements or a conditional waiver of waste discharge requirements.
 - a. For the North Coast RWQCB, replacement systems apply under Order No. R1-2017-0039 or subsequent version.
 - b. For the North Coast RWQCB, new systems file a Notice of Intent for waste discharge requirements.
 - c. For the San Francisco Bay RWQCB, file a Notice of Intent for waste discharge requirements.
 3. Upon acceptance of the Notice of Intent by the RWQCB, the County will issue the permit for construction.
- B. To mitigate other SWRCB OWTS Policy prohibitions or standards:
1. The owner shall submit a design to the Permit Authority that justifies how the design satisfies the intent of the prohibition or standard not being achieved.
 2. Upon plan review approval by Permit Authority, the owner shall ~~the~~ file a Notice of Intent with the appropriate RWQCB for waste discharge requirements, waiver of waste discharge requirements or a conditional waiver of waste discharge requirements.
 - a. For the North Coast RWQCB, apply under Order No. R1-2017-0039 or subsequent version.
 - b. For the San Francisco Bay RWQCB, file a Notice of Intent for waste discharge requirements.
 3. Upon acceptance of the Notice of Intent by the RWQCB, the County will issue the permit for construction.

22.2 Non-Domestic Waste Not Subject to the SWRCB OWTS Policy

While the Permit Authority is not authorized to permit the waste processing and/or disposal of non-domestic waste, there are structural, mechanical, electrical and/or plumbing aspects that fall under the Permit Authority's jurisdiction pursuant to the California Model Building Codes. This section provides a process for those structural, mechanical, electrical and/or plumbing aspects.

- A. The owner shall submit a building permit application to the Permit Authority showing the structural, mechanical, electrical and/or plumbing aspects pursuant to the California Model Building Codes.
- B. Permit Authority will plan review the building permit application and provide comments as necessary.
- C. Upon review and compliance with the California Model Building Codes, Permit Authority shall issue and/or final the appropriate building permit(s).
- D. Issuance or final of a building permit(s) by the Permit Authority is not an authorization to discharge waste.
- E. For potential waste discharges not covered by the SWRCB OWTS Policy, the owner is responsible to apply to the appropriate Regional Water Board for coverage under the Porter-Cologne Water Quality Control Act.